

SOLAR STANDARD
ON ALL UNITS

ULTRA LITE & NANO TRAVEL TRAILERS

APEX



Emerald Rated

Coachmen[®]
Recreational Vehicles
A division of Forest River, Inc.

APEX

NANO

HIT THE ROAD TO ADVENTURE WITH
APEX'S LIGHT-WEIGHT TOWABLE RVS



208 BHS



203 RBK / 208 BHS



203 RBK / 208 BHS



208 BHS

LIGHT & FUN

Travel is easy with Apex style and comfort. These narrow-body trailers are ideal for towing with half ton trucks and most smaller SUVs, with weights ranging from 3,000 lbs. up to 4,500 lbs. All Nano floor plans are designed with rich, warm interiors, full-sized bathrooms, contemporary cabinetry, fabrics and flooring.

The 186 BH, 203 RBK, and 208 BHS come standard with a 60" x 80" queen bed, or you can add an optional Murphy Bed with Jack Knife sofa, shown at right.



The lower double bunk in 208 BHS flips up to access a large storage area.



208 BHS

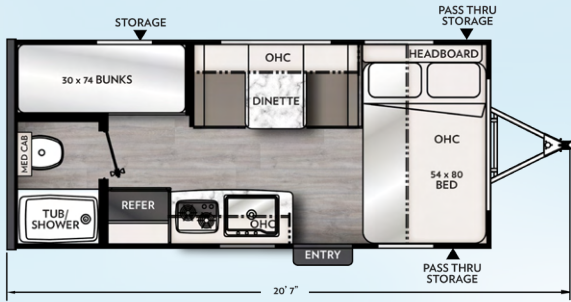

185 BH

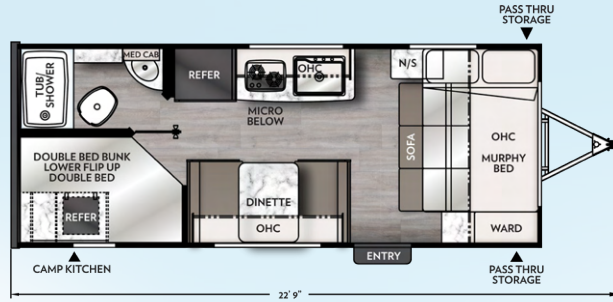

186 BH

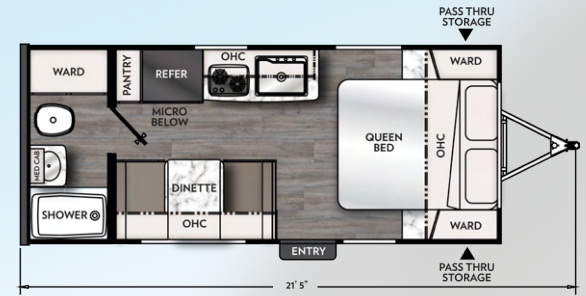

187 RB

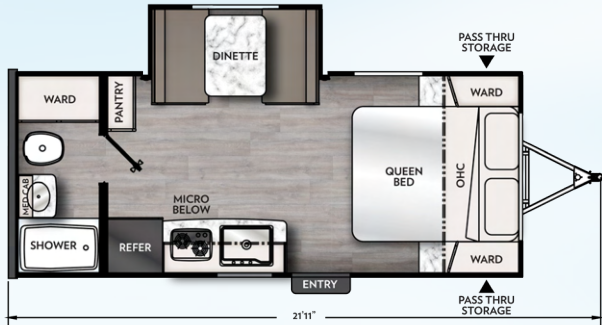

191 RBS

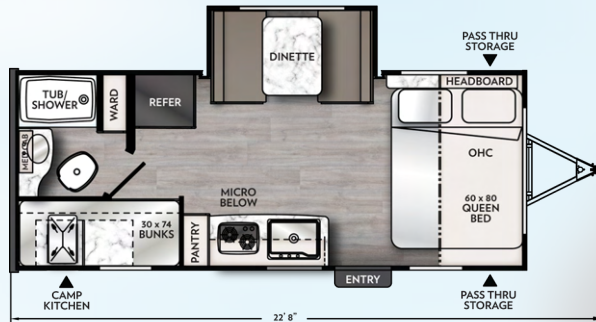

194 BHS

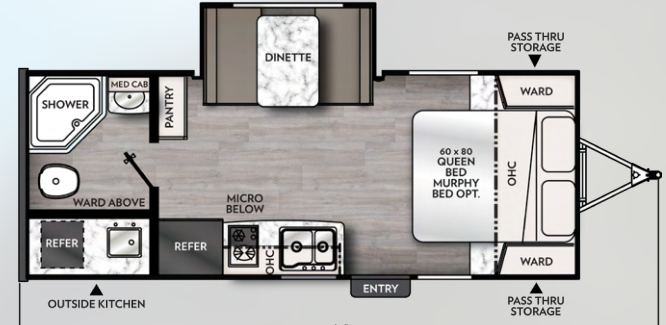

203 RBK

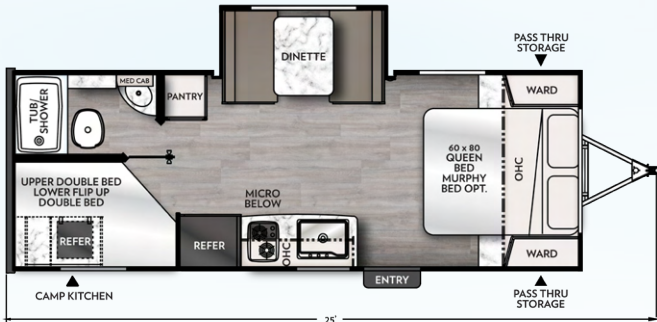

208 BHS

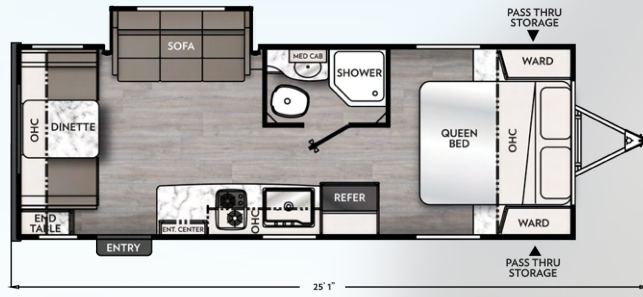

213 RDS

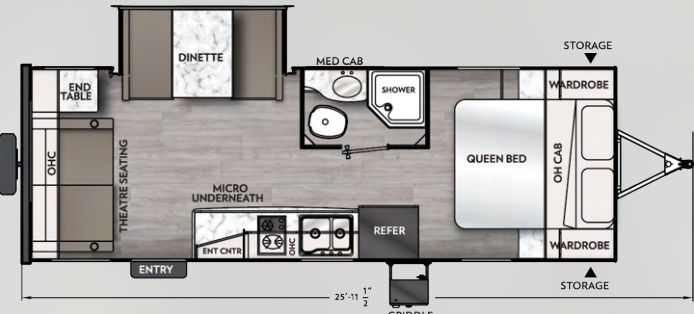

221 RLS



APEX NANO	185 BH	186 BH	187 RB	191 RBS	194 BHS	203 RBK	208 BHS	213 RDS	221 RLS
Hitch Weight	384	432	390	426	454	470	504	494	503
Carrying Capacity	1,234	1,074	1,342	1,114	910	2,084	1,712	1,806	1,806
UVW	3,202	3,597	3,246	3,552	3,784	3,916	4,198	4,115	4,194
GVWR	4,700	4,700	4,700	4,700	4,800	6,000	6,000	6,000	6,000
Ext. Length (Incl. Bumper to Hitch)	20' 7"	22' 11.5"	21' 5"	21' 11"	22' 8"	23' 5"	24' 11"	25' 2"	25' 2"
Ext. Height (Incl. A/C)	9' 10"	9' 9"	9' 10"	9' 10"	9' 10"	9' 11"	9' 11"	9' 11"	9' 11"
Int. Height (Coach)	77"	77"	77"	77"	77"	77"	77"	77"	77"
Awning Length	12'	15'	12'	12'	14'	15'	14'	15'	15'
Fresh Water Capacity (gal.)	52	52	52	52	52	52	52	52	52
Grey Water Capacity (gal.)	27	27	27	27	27	35	35	35	35
Waste Water Capacity (gal.)	27	27	27	27	27	35	35	35	35

Refer to chart descriptions on back cover.

APEX

ULTRALITE

OUR MODERN INTERIORS ARE BEAUTIFULLY PAIRED WITH AN INNOVATIVE USE OF SPACE TO MAKE CAMPING COMFORTABLE AND EASY.



251 RBK



SELECT MODELS

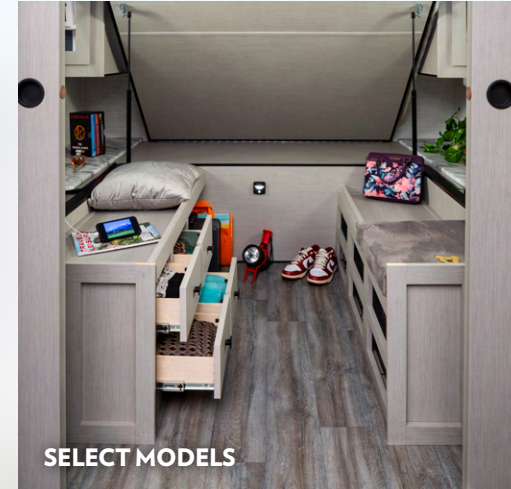

SELECT MODELS



251 RBK

LIGHTWEIGHT ADVENTURE

An Apex Travel Trailer does not just start off as a frame, walls and roof... it begins with an idea! Our belief is that getting the little things right is a BIG THING! The Apex UltraLite is not like other lightweight trailers. It is much smarter because we set new, higher standards for this innovative, truly lightweight trailer.

The 251 RBK is perfect for couples who like to kick back and relax with all the amenities of home. It's open concept living at its finest, with comfortable seating located directly across from the TV for a great view, and a booth dinette for those game nights.



251 RBK

The outside kitchen is the perfect spot to grab some food and keep the fun going.

7.5' WIDE MODELS

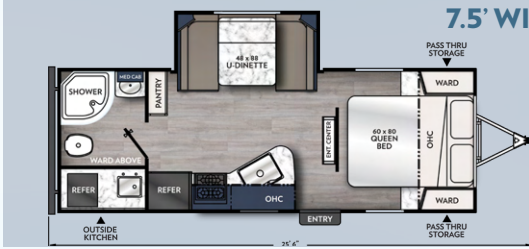

215 RBK



245 BHS



211 RBS



243 FKS



251 RBK



256 BHS



264 RKS



265 RBSS



266 BHS

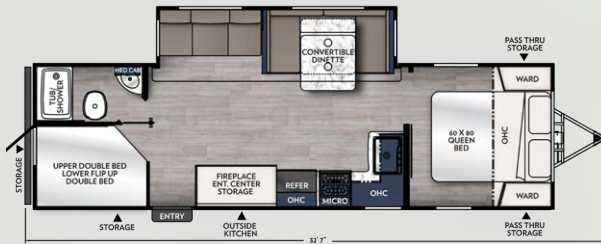

284 BHSS



293 RLDS

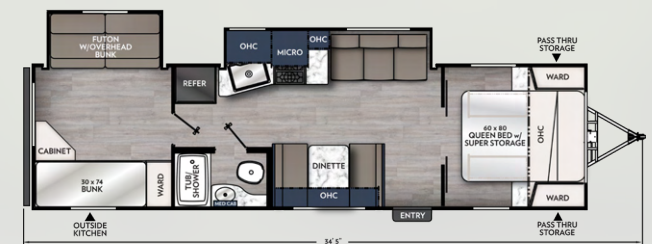

300 BHS



Apex 8' WIDES

	215 RBK	245 BHS	211 RBS	243 FKS	251 RBK	256 BHS	264 RKS	265 RBSS	266 BHS	284 BHSS	293 RLDS	300 BHS
Hitch Weight	446	578	587	810	570	694	718	734	934	722	832	672
Carrying Capacity	2,135	1,914	1,938	1,654	2,016	2,128	1,618	1,948	1,520	1,578	1,360	1,625
GVW	4,365	4,586	4,891	5,906	4,984	5,472	5,982	5,652	6,080	6,017	6,440	5,975
GVWR	6,500	6,500	7,000	7,600	7,000	7,600	7,600	7,600	7,600	7,600	7,800	7,600
Ext. Length (Incl. Bumper to Hitch)	25' 6"	27' 7"	26' 2"	29' 5"	29'	30' 1"	31' 10"	30' 5"	32' 11"	32' 7"	34'	34' 5"
Ext. Height (Incl. A/C)	10' 2"	10' 2"	10' 5"	10' 7"	10' 1"	10' 5"	10' 4"	10' 6"	10' 5"	10' 7"	10' 7"	10' 1"
Int. Height (Coach)	78"	78"	78"	78"	78"	78"	78"	78"	78"	78"	78"	78"
Awning Length	13'	18'	15'	20'	16'	16'	18'	18'	20'	18'	18'	18'
Fresh Water Capacity (gal.)	52	52	50	50	50	50	50	50	50	50	50	50
Grey Water Capacity (gal.)	35	35	35	70	35	70	70	70	35	70	70	35
Waste Water Capacity (gal.)	35	35	35	35	35	35	35	35	35	35	35	35

APEX STANDARDS AND OPTIONS

	UL	NANO
VALUE PACKAGE (MANDATORY)		
Vacuum-bonded Laminated Azdel Fiberglass Side Walls		
Vacuum-bonded Laminated Azdel Fiberglass Rear Wall		
Vacuum-bonded Laminated Crowned Roof	x	x
Laminated Aluminum Framed Floor	x	x
Fiberglass Front Cap w/LED Lighting and Windows	x	x
Aluma-cage Construction	x	x
Two-Tone White and Grey Fiberglass Exterior Sidelwalls		
Front Stone Guard	x	x
Enclosed Underbody Forced Air Heat	x	SM
Aluminum Wheels	x	x
Spare Tire	x	x
Slide Topper Prep	x	
Backup Camera Mount	x	x
Power Tongue Jack	x	
Stabilizer Jacks (4)	x	x
LP Brt	x	x
200Watt Solar Panel w/ 30 AMP Control Charger	x	x
13.5 BTU A/C (Ducted on 8' wide)	x	x
Ducted/Duct Vent Furnace (Floor Plan Specific)	x	x
DSI Gas/Electric Water Heater	x	x
Hot/Cold Outside Shower	x	x
Black Tank Flush Kit	x	x
Power Awning w/Lighting	x	x
Swingway Assist Handle	x	x
Friction Hinge Entrance Door	x	x
Solid Step	x	x
Slam Latch Baggage Detaches	x	
LED Motion Sensitive Light in Exterior Storage Area	x	
Had Valances w/Night Shades Throughout	x	x
LED Interior Lighting Throughout	x	x
Microwave	x	x
Lighted, Flush-mount Burner High Output Range w/Oven		
8 Cu.ft12V Refrigerator	x	x
Stainless Steel Single Bowl w/Flush-mount Cover	x	x
Access Door Under Dinette	SM	SM
Interior Convenience Center	x	x
Digital TV Antenna w/Cable Hook-ups and WiFi Capability	x	x
USB Charging Station	x	x
LED TV	x	
Hide-A-Bed Sofa (Deep slides only)	x	
Tub Surround	x	x
Skylight in Bath	x	x
Mattress with Cover	x	x

INTERIOR AND CODE

	UL	NANO
Casino Bisque Cabinetry	x	x
Shaker Cabinet Door Frames	x	x
Stile and Rail Cabinet Construction	x	x
One Piece Seamless Edge Countertops	x	x
Residential Style Flooring	x	x
Overhead Bedroom Cabinets w/Side Wardrobes	x	x
Had Valances w/Night Shades Throughout	x	x
Pedestal Dinette Table (Fold Up Table on 211RB)	x	
Large Oversized Booth or U-shaped Dinette w/Sliding Door Storage Access	x	
Residential Sofa	x	SM
LP Leak Alarm	x	x
Fire Extinguisher	x	x
Smoke Alarm	x	x
Carbon Monoxide Detector	x	x

ELECTRICAL / HEATING/AC

	UL	NANO
Furnace – Forced Air/Ducts Per Floorplan	x	x
13.5 BTU A/C (Ducted on 8' wide)	x	x
55Amp Power Center with Auto-detect, Lithium-compatible		
Outside Receptacle GFI	x	x
200Watt Solar Panel w/ 30 AMP Control Charger	x	x
Wireless Bluetooth Speaker	x	x
Detachable Marine Style PC Cord	x	x
USB Chargers	x	x

GALLEY

	UL	NANO
8 Cu.ft12V Refrigerator	x	x
Residential Style Oven	x	
Flush-mount Burner Stovetop		x
Flush-mount Burner Stovetop	x	
Power LED Lighted Range Hood	x	
Microwave	x	x
Stainless Steel Single Bowl w/Flush-mount Cover	x	x
One Piece Seamless Edge Countertops	x	x
Matte Black Hardware	x	x

BATH AND WATER

• 6 Gal. Gas/Electric DSI Water Heater	x	x
• Power Bath Vent	x	x
Water Heater Bypass Valve	x	x
On Demand Water Pump	x	x
Below Floor Low Point Drains	x	x

	UL	NANO
Foot Flush Toilet	x	x
Tub Surround	x	x
Glass Show Door	SM	SM
Hand-crafted Wood Medicine Cabinet	x	x

EXTERIOR/ CONSTRUCTION

Aluma-Cage Construction	x	x
Vacuum-bonded, Aluminum Trussed Roof w/Dicor Cross ex Roof Membrane (R-11 – 7½' wide, R-14 x 8' wide)		
Vacuum-bonded Laminated Azdel Fiberglass Sidelwalls	x	R-1
Vacuum-bonded Azdel Fiberglass Rear Wall	x	x
Laminated Aluminum Framed Floor (R-11)	x	x
Corrosion Resistant Powder Coated Frame	x	x
I-beam Chassis Construction	x	x
Heated and Enclosed Underbody Forced Air	x	SM
Gutter Rail	x	x
Dual 20 Lb. Tanks w/Cover	x	x
Dual Battery Tray	x	x
Solid Step	x	x
Tinted Safety Glass Radius Windows	x	x
Radius Entrance Door w/Window and Friction Hinge	x	x
Dead Bolt Lock	x	x
Radius Slam Latch Baggage Door	x	
Break Away Switch	x	x
Super-Lube Axles	x	x
Radiant Heats	x	x
Frame Receiver Prep	SM	SM
Battery Disconnect Switch	x	x

OPTIONS

Frameless Dark Tint Windows	x	
Stargazer		x
15K BTU A/C Upgrade	x	x
50Amp Service w/Second (Forced) 13.5K BTU A/C		
12v Heat Pads		x
Theater Seating	SM	
Goodyear® All-Terrain Tires		x
Murphy Bed		SM

SM = SELECT MODELS

APEX CONSTRUCTION

Construction Features

- 3M Breathable graphics
- Tinted, safety glass windows
- Welded aluminum structure, vacuum-bonded sidewalls and rear wall, laminated floor
- Aluminum reinforced vacuum-bonded roof
- Dicor Crossflex roofing membrane
- Azdel composite exterior/interior sidewall and rear wall panels
- Aerodynamic front profile with fiberglass front cap and integrated window
- [2] 20 lb. LP tanks
- Insulated slam latch doors with magnetic hold-ups [N/A Nanos]
- Smooth exterior fiberglass skin
- Aluminum framed openings
- Fully enclosed, heated underbelly [Double axle models]
- Fully welded tubular aluminum floor structure
- Slide system
- Residential Style linoleum flooring
- Powder E-coated, welded I-beam frame with full-depth crossmembers
- SuperLube axles
- Radial tires

Apex features the combination of environmentally friendly Azdel wall boards inside, and out. Using Alomicage Construction maximizes strength while minimizing weight. These Ultralite Travel Trailers are designed for towing by today's half-ton trucks, and SUVs. From 18' to 34'. All units are available under 6,800 lbs.



Fiberglass Front Cap

- ¾ Front fiberglass cap for superior strength
- Automotive glass front window with superior UV protection
- Front stone guard
- Integrated LED accent lights
- Vacuum Bonded Sidewalls and Roof
- Stronger construction
- Lighter weight



Apex is proud to be one of three products to receive the Emerald Level Certification, the highest rated level possible.

As a Certified Green RV, APEX utilizes effective production techniques in combination with healthy materials, plus efficient usage of energy and water to produce a high quality RV with less environmental impact.

Check us out at:

coachmenrv.com/travel-trailers/apex

LIGHTWEIGHT DURABILITY



Double axle floor plans only.



ALOMICAGE™ CONSTRUCTION

Lower Center of Gravity for Better Towability

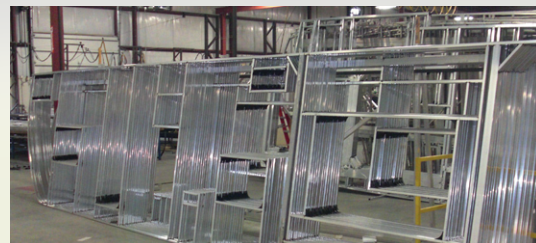

Welded Aluminum Framing

Durable, lightweight aluminum cage – individually framed cut-outs to make for stronger sidewalls and reduce water leaks.



Aluminum Reinforced Vacuum-bonded Roof

The aluminum framed, laminated roof is lighter than the competition, rigid and fully walkable.

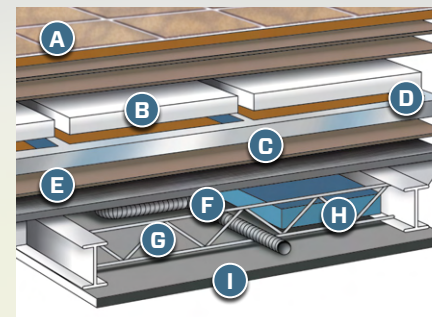

Six Layer Laminated Floor

- A Residential durable insulated floor covering
- B Double layer Luan plywood top decking
- C Welded aluminum frame
- D Block foam structural insulation
- E Luan plywood bottom decking
- F Darco waterproof floor wrap
- G Cross member support
- H Holding tanks
- I Heated and enclosed underbelly [Double axle models]

EXPERIENCE YOUR OWN ULTRALITE ADVENTURE

Versatile Apex Travel Trailers provide a perfect home base, wherever the road leads.



THE ENTIRE APEX LINEUP IS PERFECT FOR SMALLER TOW VEHICLES.



423 N. Main Street • P.O. Box 30 • Middlebury, IN 46540
To learn more about Coachmen RV and our products and see how Coachmen is making the easy life easier, visit <https://coachmenrv.com/travel-trailers/apex-ultra-lite>.



YOUR APEX DEALER

Coachmen Interactive Mobile Manuals

Download your Coachmen mobile app or visit our dynamic online manual to enhance your ownership experience. These interactive options provide incredible ease and insight into use, maintenance and enjoyment of your Coachmen product. Ranging from "How-To" videos, pictures and illustrations of various components, systems and features to fully searchable content and downloadable PDFs for individual component owner's manuals, answers are always just a click away.

Find us on Facebook



**24/7 EMERGENCY
ROADSIDE ASSISTANCE
WITH VEHICLE PURCHASE***

<p>TOWING JUMP-STARTS TIRE CHANGES FLUID DELIVERY LOCKOUT SERVICE</p>	<p>WINCH-OUT MOBILE MECHANIC TECHNICAL SUPPORT DEALER LOCATOR SERVICES</p>
---	--

SAFERIDERV
MOTOR CLUB

*VALID FOR 1 YEAR FROM DATE OF PURCHASE

GVWR (Gross Vehicle Weight Rating) - is the maximum permissible weight of the unit when fully loaded. It includes all weights, inclusive of all fluids, cargo, optional equipment and accessories. For safety and product performance do NOT exceed the GVWR.

GAWR (Gross Axle Weight Rating) - is the maximum permissible weight, including cargo, fluids, optional equipment and accessories that can be safely supported by a combination of all axles.

UVW (Unloaded Vehicle Weight)** - is the typical weight of the unit as manufactured at the factory. It includes all weight at the unit's axle(s) and tongue or pin and LP Gas. The UVW does not include cargo, fresh potable water, additional optional equipment or dealer installed accessories. *Estimated average based on standard build optional equipment.

CCC (Cargo Carrying Capacity)** - is the amount of weight available for fresh potable water, cargo, additional optional equipment and accessories. CCC is equal to GVWR minus UVW. Available CCC should accommodate fresh potable water (8.3 lbs per gallon). Before filling the fresh water tank, empty the black and grey tanks to provide for more cargo capacity. **Estimated average based on standard build optional equipment.

Each Forest River RV is weighed at the manufacturing facility prior to shipping. A label identifying the unloaded vehicle weight of the actual unit and the cargo carrying capacity is applied to every Forest River RV prior to leaving our facilities. The load capacity of your unit is designated by weight, not by volume, so you cannot necessarily use all available space when loading your unit. All information contained in this brochure is believed to be accurate at the time of publication. However, during the model year, it may be necessary to make revisions and Forest River, Inc., reserves the right to make all such changes without notice, including prices, colors, materials, equipment and specifications as well as the addition of new models and the discontinuance of models shown in this brochure. Therefore, please consult with your Forest River dealer and confirm the existence of any materials, design or specifications that are material to your purchase decision.
©2021 Apex by Coachmen RV, a Division of Forest River, Inc., a Berkshire Hathaway company. All rights reserved. 12/23 CHM 2258



Learn More
Scan this barcode using a QR Reader on your smart phone to learn more about Forest River.



A Berkshire Hathaway company.