

FIREFLY



INTEGRATIONS

# VEGATOUCH

Forest River Forester V1

## FORESTER

BY FOREST RIVER



**Imagination ~ Innovation ~ Integration**

1013 Elroy Drive, Middlebury, Indiana 46540 (574) 825-4600

# Forest River Forester V1 Manual

The information contained in this manual is a general overview of the Firefly system and is subject to change at any time.

- 2 Table of Contents
- 3 Touchscreen Overview
- 4 Home
- 7 Auto Gen Start (AGS) Settings
- 8 Lights
- 9 Climate Control
- 11 Slides & Awnings
- 12     Leveling
- 14 Settings
  - 16     Mobile App
  - 17     Vegatouch Mira Setup
  - 21     Switch Panel Info
  - 22     Wireless Switch Pairing
  - 23     Network Diagnostics
  - 25     Display Colors
  - 26     Options
- 27 Overcurrent Detection
- 28 SSP17 Switch Panels
- 29 G12 DC Panel
- 30 Networking
- 31 Network Status Indicators
- 32 Mira NET LED Status Key
- 33 System Diagrams



**FIREFLY**  
INTEGRATIONS

**1013 Elroy Drive**  
**Middlebury, Indiana**  
**46540**  
**Phone: (574) 825-4600**  
**Support@Fireflyint.com**



# Touchscreen Overview

Tap any icon from the vertical navigation menu to select the desired page. The currently selected page will always be listed in the top corner of the screen.



This symbol will appear whenever a fault condition is present. Tap the triangle to visit the Network Diagnostics screen.

The screenshot displays a touchscreen interface with a dark green background. At the top, a green bar contains the word "HOME" on the left, a warning triangle icon in the center, and the time "6:55" on the right. A vertical navigation menu on the left side is highlighted in green and contains icons for Home, AGS, Lights, Climate, Slides, and Settings. The main area is divided into several panels:

- Living Ceiling, Kitchen Accent, Bed Ceiling:** Each has a light bulb icon and a double-headed arrow. Below them is a "Light Master" control with "ON" and "OFF" buttons.
- Water Heaters:** Four tanks labeled "FRESH", "GREY", "BLACK", and "LP" with level indicators. Below are "Water Heater Gas" and "Water Heater Electric" buttons.
- Climate:** Shows "Climate 72°" with a fan icon. Includes "Water Pump" and "Tank Heaters" buttons.
- House:** Shows "12.3V" and "Start" button. "GEN Stopped 12.5" with "Stop" button.
- Chassis:** Shows "12.3V" and "AGS" button. "DISABLED" button.

Navigation Menu



# Home

Buttons will turn Blue while a circuit is on and Grey once the circuit has been turned off. This color change is known as showing status.

1 Individual light controls.

2 Light Master controls all interior lights at once. When Light Master Off is pressed, it will remember which lights were on. Then, when Light Master On is pressed, it will only turn on the lights that are in memory. To turn on all lights again, press and hold Light Master On for at least one second.

\*Troubleshooting – Memory is rewritten each time Light Master Off is pressed. In the case that it is pressed twice in a row, it will remember that no lights were on and just touching Light Master On won't turn on any lights. Press and hold Light Master On to turn the lights back on. Note: Light Master On/Off buttons will always appear blue and will not show feedback at any time.

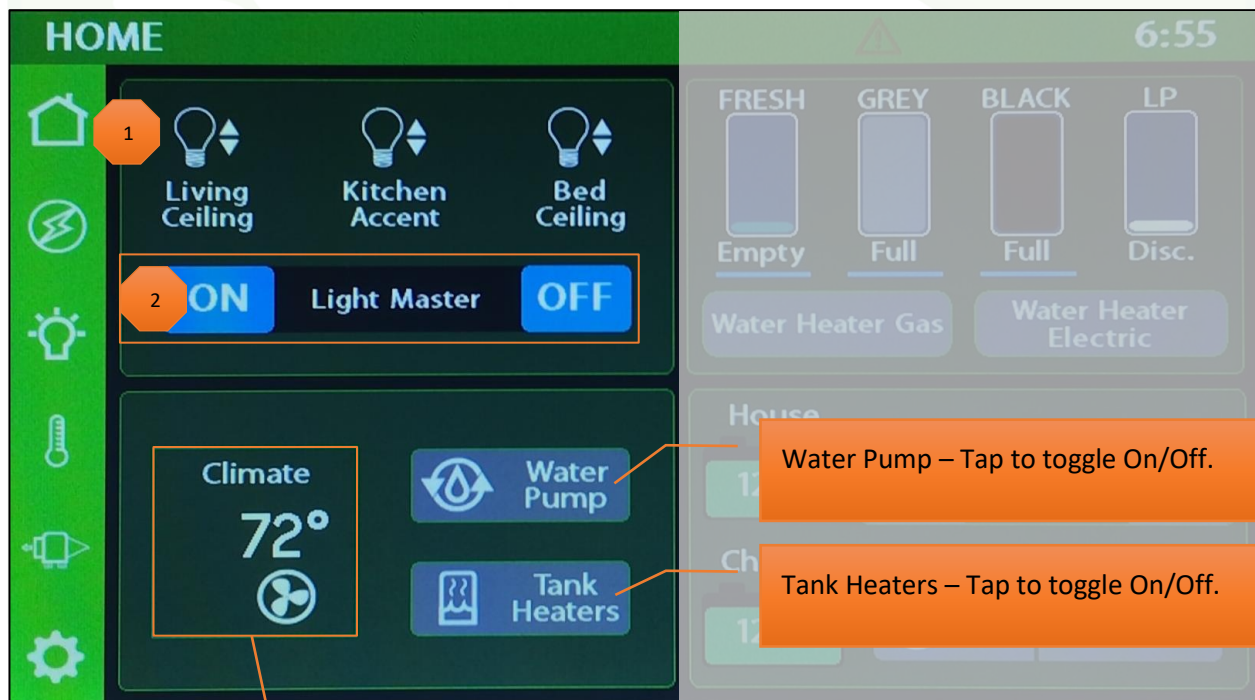

Water Pump – Tap to toggle On/Off.

Tank Heaters – Tap to toggle On/Off.

Current temperature with currently active climate mode graphic.



### Fluid Tank Readings (TruTank):

- Displays in 5 percent increments.
- Below 10% will read “Empty” and the tank level will show Empty.
- 90% and above will read “FULL.” and the tank shows accurate level.

### LP Tank Readings:

- Below 25% will read “Low” and the tank level will show as normal.
- From 25% to 75%, the tank level and percentage will show as normal.
- From 75% to 80%, will read “Full” and the tank level will show as normal.
- 80% and above will read “Disc.” and the tank level will be empty.

Individual tank graphics represent the percentage filled for holding tanks.

Blue lines under tanks on startup - Possible Issue: On initial 12V system power up, the black and gray tanks read full with a blue line under them and the fresh tank reads empty with a blue line under it.

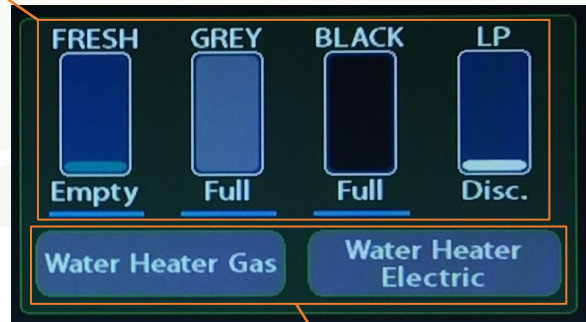

Possible cause: On initial power up, if there is no water in the tank, the system may have difficulty detecting the no water condition. As a result, it will display a blue line under the tank reading for the appropriate tank and indicate the following:

- Fresh Tank – Shown with a blue line under the tank reading and the tank graphic as being empty. Because the system is not detecting the empty fresh tank correctly, it does not have valid data to display. As a precaution, it will display the fresh tank graphic as empty as this is the least favorable condition for the tank.
- Grey Tank – Shown with a blue line under the tank reading and the tank graphic as being full. Because the system is not detecting the empty gray tank correctly, it does not have valid data to display. As a precaution, it will display the grey tank graphic as full as this is the least favorable condition for the tank.
- Black Tank – Shown with a blue line under the tank reading and the tank graphic as being full. Because the system is not detecting the empty black tank correctly, it does not have valid data to display. As a precaution, it will display the black tank graphic as full as this is the least favorable condition for the tank.

Solution: Add at least 3 inches of water to the tank to allow the sensor to properly initialize. Once there is water covering the sensor, it should start to report correct readings and display the tank levels correctly.

House Voltage – the voltage coming from your house batteries. Note: Battery graphics will display Red if below 12V.

Chassis Voltage – the voltage coming from your engine battery.



Generator Start - hold Start to start the generator (1 second delay).

Generator Stop – Hold Stop to stop the generator.

Tap to Enable/Disable AGS.

5

If AGS is enabled before the coach is connected to shore power, the Shore Override status message will be displayed and AGS will be disabled. AGS will automatically re-enable once shore power has been disconnected.

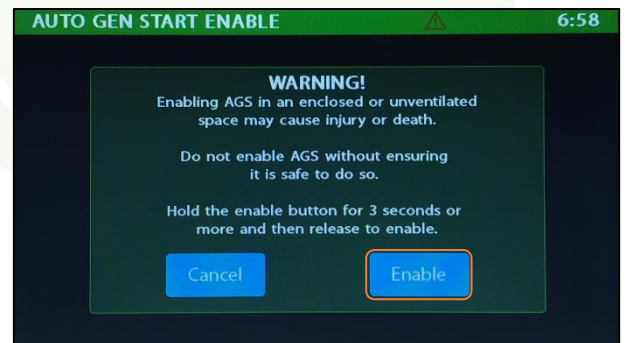

5 AGS WARNING – to ensure safety, AGS will not be activated until you hold the Enable button (from the Warning screen) for at least 3 seconds.

**Set Gen Hours** - Press and Hold the gen hours display to enter the Set Gen Hours screen. Tap the buttons to enter your desired hours then tap Yes to save and exit.

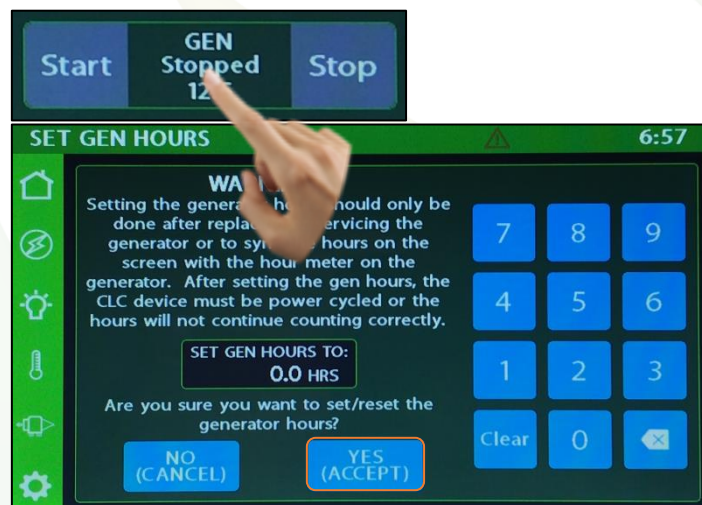



# Auto Gen Start (AGS) Settings

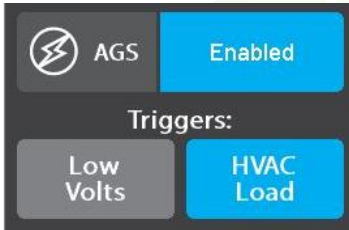

Tap to Enable/Disable AGS. A warning message will require action to Enable.

Trigger Options – Automatically start the generator using specified voltage settings (Low Volts) or when A/C or Heat starts (HVAC). Select one or both triggers. If no triggers are selected, AGS will not run. Disable HVAC Load while connected to shore power to keep the generator from starting.

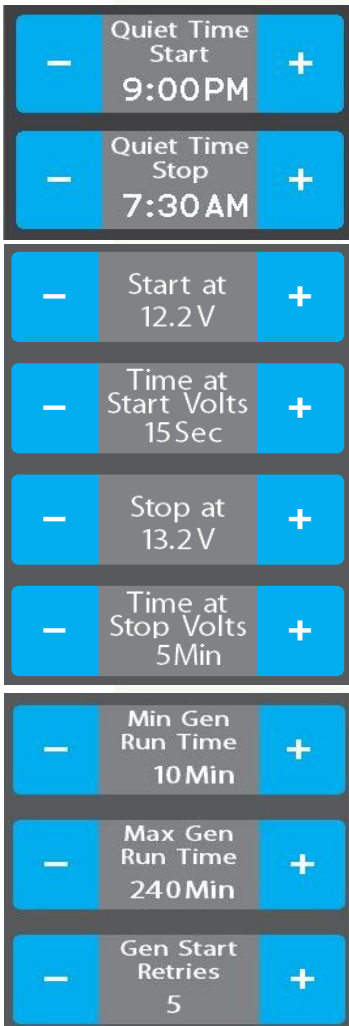

Quiet Time Start - Use the +/- buttons to select the starting point for Quiet Time, the hours that your generator will not run in an effort to reduce noise.

Quiet Time Stop - Use the +/- buttons to select the stopping point for Quiet Time. AGS will work normally at this point.

Start at Volts - The generator will start when the voltage drops to this set point depending on "Time at Start Volts" setting below. (Range 10.5v – 12.5v)

Time at Start Volts - The generator will start when the voltage drops to the Start at Voltage for this specific amount of time. (Range 5 seconds – 1 minute)

Stop at Volts - The generator will shut off when the voltage reaches this set point depending on "Time at Stop Volts" setting below. (Range 13.2v – 14.5v)

Time at Stop Volts - The amount of time required for the voltage to remain at "Stop at Volts" level before the generator shuts off. (Range 5min – 120min)

Minimum Gen Run Time - Use the +/- buttons to set the minimum amount of time that your generator will run once it has started. (Range 10min – 30min)

Maximum Gen Run Time - Use the +/- buttons to set the maximum amount of time that your generator will run once it has started. (Range 120min – 720min)

Gen Start Retries - Use the +/- buttons to set the number of tries that your generator will retry to start. (Range 1-5 retries)



# Lights

This screen will control the lighting for the entire coach, including the exterior. Tap any button to turn the desired light On/Off.



Lights with up/down arrows are dimmable. Press and hold these buttons to ramp the brightness up or down. Tap the buttons to toggle On/Off.

**LIGHTS** 6:58

**ON** Light Master **OFF**

**Exterior**

- Porch
- Awning
- Scare Lights

**Interior**

- Living Ceiling
- Kitchen Accent
- Stove Light
- Slide Accent
- Bed Ceiling
- Bunk D/S
- Bunk P/S
- Bath Ceiling





# Climate Control

The screenshot shows the 'CLIMATE CONTROL' app interface. At the top, it says 'Zone 1' with a current temperature of 68°. Below this is a fan speed indicator showing a fan icon with 'H' and a temperature of 73°. A vertical sidebar on the left contains icons for Home, Power, Light, Temperature, and Settings. The main control area has four modes: 1. Cool (with a snowflake icon), 2. Heat (with a wavy line icon), 3. Furnace (with a flame icon), and 4. Auto (with a thermometer icon). To the right of these modes are fan speed options: High, Low, and Auto. A 'Bath Fan' button is visible at the bottom. Three callout boxes provide instructions: one points to the temperature adjustment arrows, another points to the fan speed indicator, and a third points to the fan speed options.

Use the Arrows to select your desired set temperature.

Current zone temperature/mode/fan speed indicator.

Fan Only Mode – Available if HVAC is off. The fan will operate by choosing High or Low. Auto will turn the fan off.

- 1 Cool – Tap to operate the air conditioning. The A/C will run until the current temp reaches your desired temp and then shut off.
- 2 Heat – Tap to operate the Heat. The Heat will run until the current temp reaches your desired temp and then shut off.
- 3 Furnace – Tap to operate the Furnace. The Furnace will run until the current temp reaches your desired temp and then shut off.
- 4 Auto – Tap to put the system into Auto mode. The A/C or Heat will automatically run to keep your desired temperature consistent.

Tap the buttons below to operate a Vent fan.

Tapping the Lid Up button will open the fan without powering up the fan.

Tapping Power (ON) will raise the lid, power up the fan and bring it to medium speed. Tapping Power again (OFF) will power down the fan.

Tapping the Lid Down button will close the lid and power down the fan if it is running to prevent it from running with the lid closed.

Tap the speed buttons to manually select your desired fan speed.

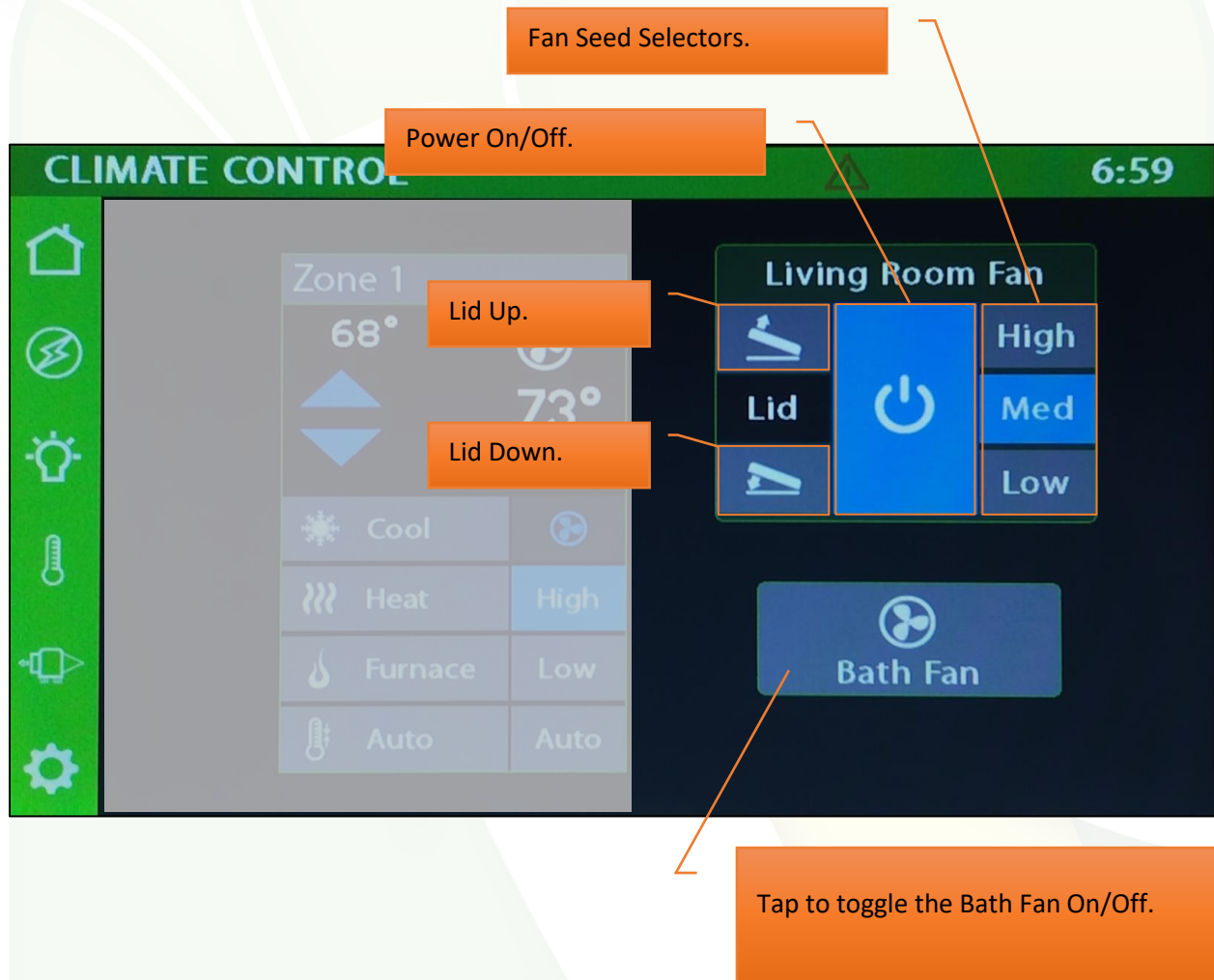



# Slides & Awnings

1 Press and Hold EXT or RET to operate the Slide and Awning.

Note – Parking Brake and Ignition are required to unlock full functionality for both the Slide and Awning.

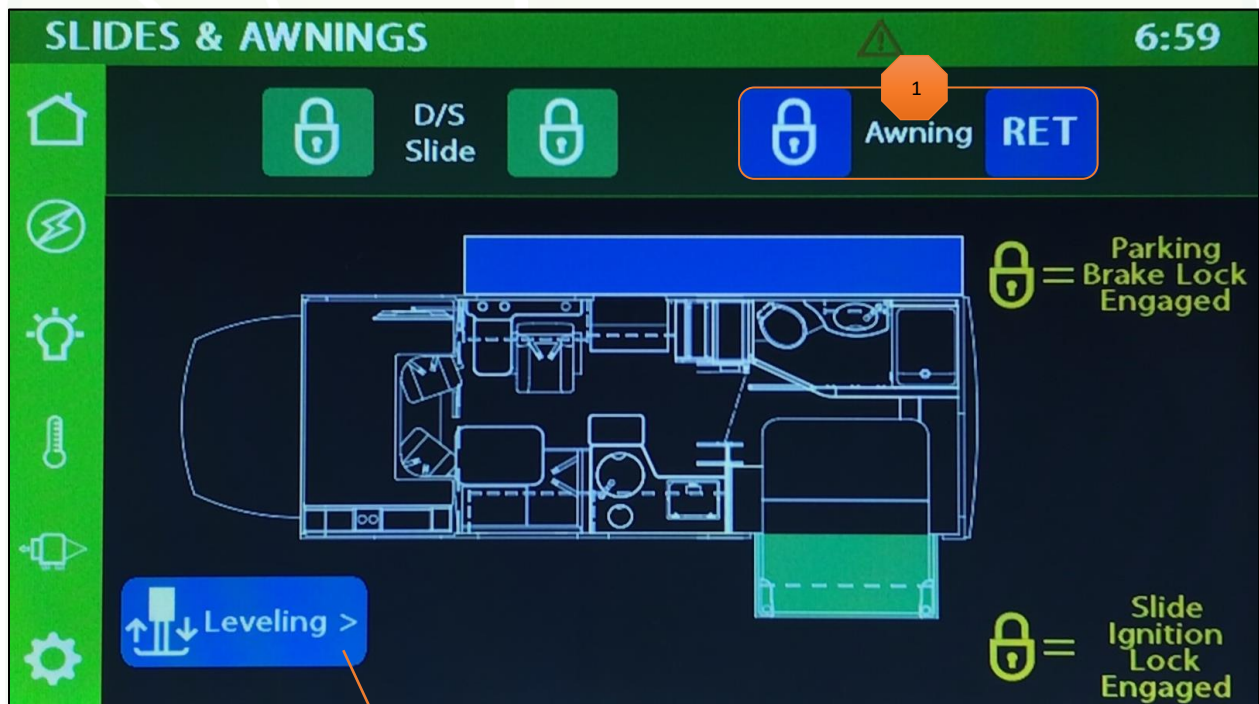

Tap to navigate to the Leveling screen.



## Slides & Awnings/Leveling

- 1 Auto Level – Tap to automatically level the coach. Tap Cancel (button status will change) to stop the operation. The corresponding red operational lights will illuminate to indicate which jacks have been extended and will stay illuminated until the jacks have been retracted.
- 2 Press and Hold the arrows to Raise/Lower the leveling jacks as needed. A single arrow will operate the jacks in pairs. For example, to Lower the Front of the coach, pressing and holding the Front Down arrow will lower the Front jacks equally. Lift your finger to stop their travel.
- 3 All Retract – Tap to fully retract all leveling jacks.
- 4 Status Indicators – Red lights will indicate the status of the Equalizer leveling system.

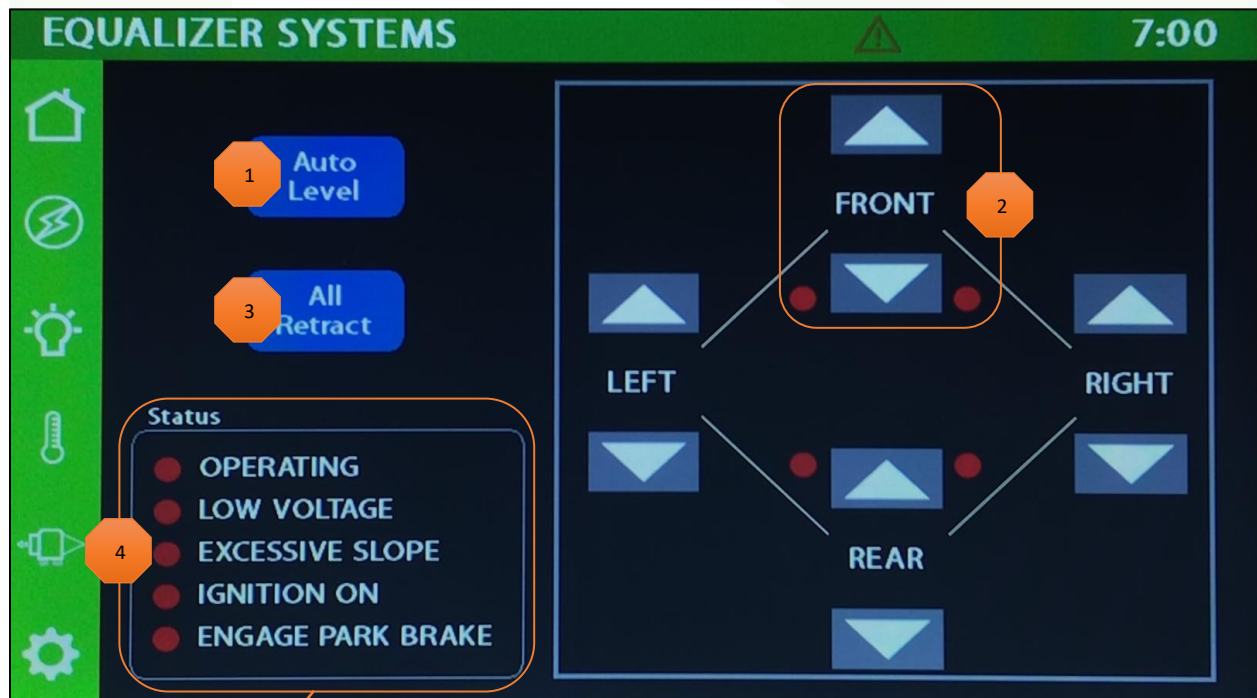

With the exception of the Operating light, these Status lights should be Off unless there is an issue. Example - Ignition On will illuminate if the Equalizer system is receiving a signal from the coach's Ignition. Turning off the Ignition will turn off the Status light and allow for the system to operate.



Press and Hold the Up/Down arrows to raise/lower the Stabilizer jacks (for Non-Equalizer leveling systems).

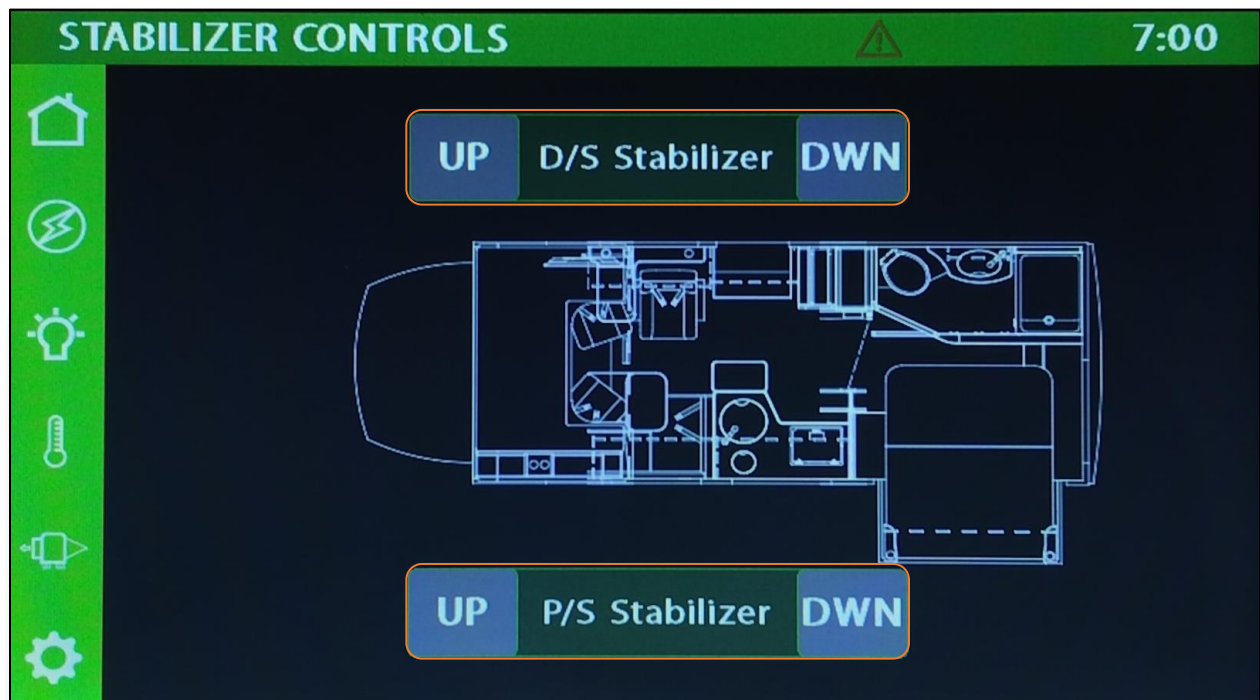



# Settings

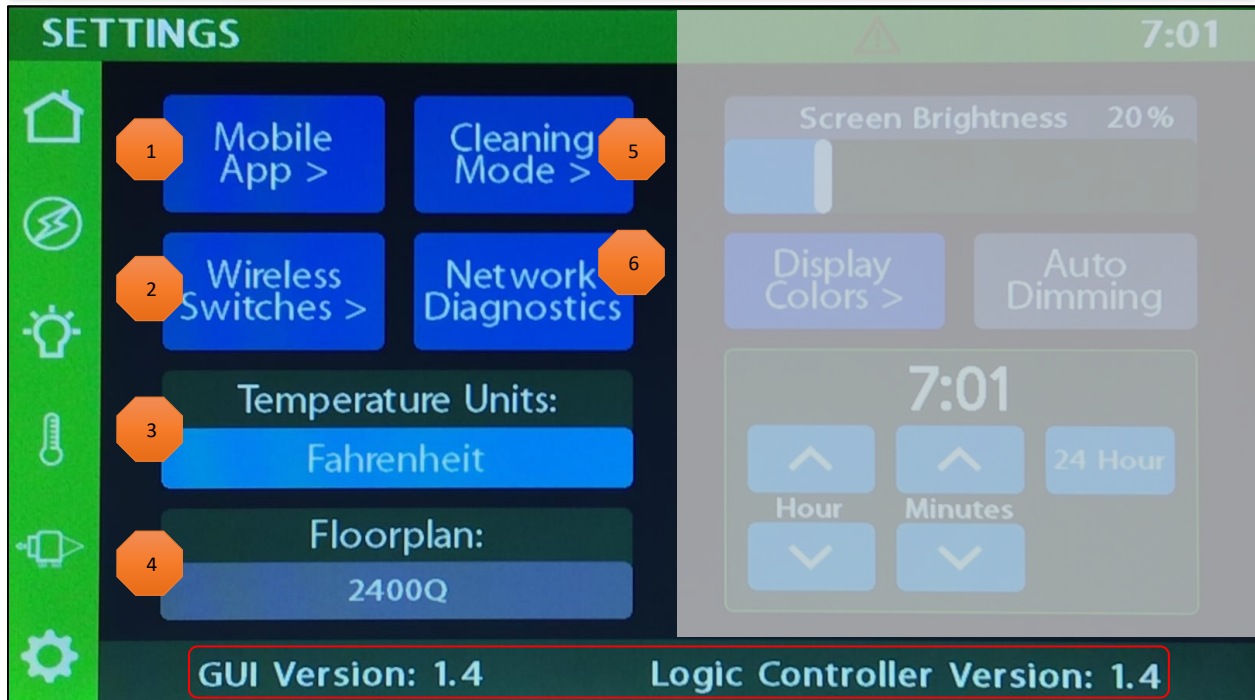

- 1 Tap to navigate to the Vegatouch Mira connection screen.
- 2 Tap to navigate to the Wireless Switch display screen.
- 3 Tap to select between Fahrenheit and Celsius.
- 4 Floorplan display.
- 5 Tap to disable the touchscreen for 15 seconds for the purpose of cleaning.
- 6 Tap to navigate to the Network Diagnostics page.

Note the GUI and Logic Controller versions at the bottom of the screen. Please have these numbers available before calling technical support.

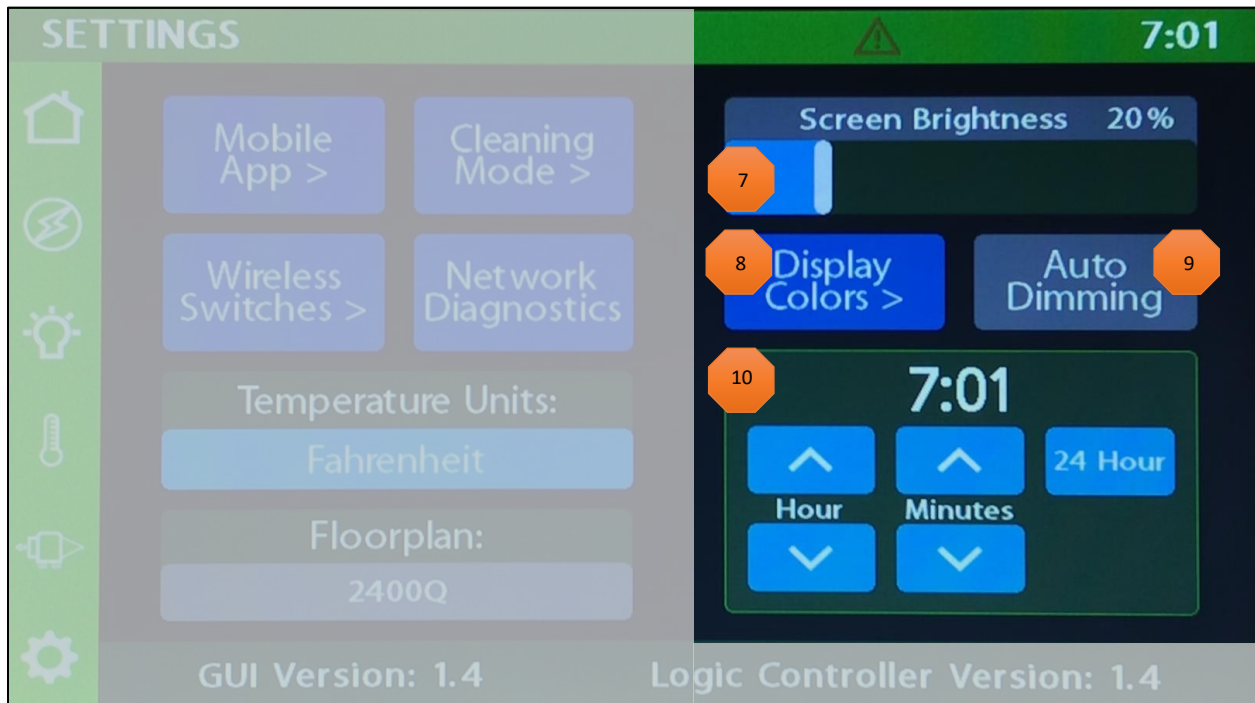

- 7 Drag the slider to adjust screen brightness.
- 8 Tap to visit the Display Colors page to customize the look of your touchscreen.
- 9 When Auto Dimming is enabled, the screen will enter sleep mode after 60 seconds of inactivity. Tap anywhere on the screen to wake it up. Please note that even if Auto Dimming has been disabled, the screen will still enter sleep mode after 4 hours of inactivity during daytime hours (5am – 10:59pm) and after 15 minutes of inactivity during night time hours (11pm-4:59am) as the result of a built in screen saver that cannot be disabled.
- 10 Tap the buttons to set the time or select 24-hour time mode.



## Settings/Mobile App

Vegatouch Mira is a wireless control module that easily connects to any Android or iOS device to give total control to many electrical, electronic and mechanical systems in your coach. Pair any device with the coach's built-in interface to monitor and control many coach components.

**MOBILE APP** 7:01

Download the Vegatouch Mira app from Google Play Store or the App Store.

Mira ID:  
**Mira: 180427**

Mira PIN:  
**777777**

[Reset PIN to Default](#)





# Vegatouch Mira Setup

**Notice:** Make sure that Bluetooth is turned ON in your smart device settings before proceeding.

## Locate the Login Information:

The login information can be found by clicking on the Mobile App button on the settings page of the touchscreen or from the Mira module's label.



## Download:

Download Vegatouch Mira from the Google Play store or the App Store. Once the download has finished, install the app and open it.

## Setup:

Tap SCAN to find the Mira Module's signal. After scanning, any Mira Module in your area will appear on the screen. Tap the ID # that matches the one on your Mira label. Enter the PIN number from the Mira label and press AUTHENTICATE to connect to the system.

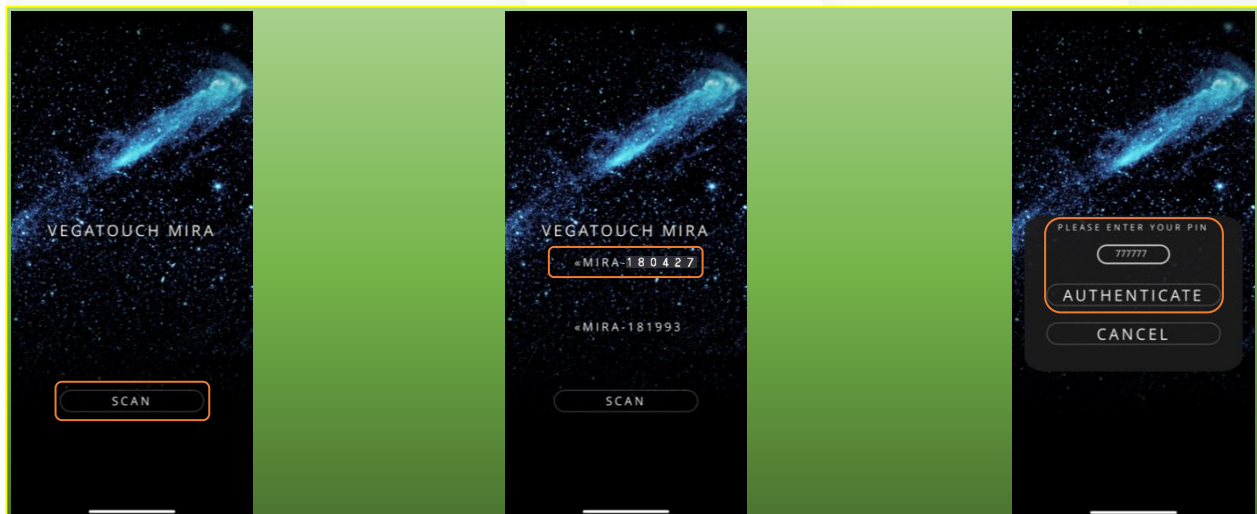

## Notice: iOS Setup Tips

Turn on Bluetooth to allow Vegatouch Mira to connect to Accessories.

If you do not have Bluetooth turned ON in your iOS settings you will see this screen. Do not click OK, you must click SETTINGS. Your Bluetooth Settings page will now appear and you should turn Bluetooth ON.

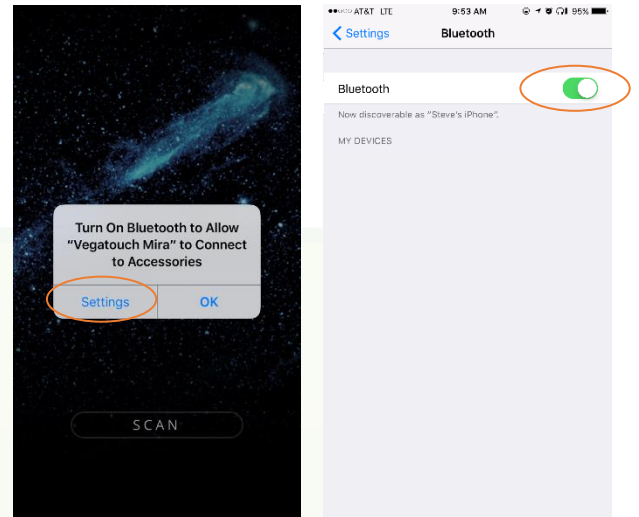

## Location Services Required

To enable Location Services on your Apple device:

1. Go to settings/Privacy/Location Services.
2. Make sure that Location Services is ON.
3. Scroll down to find your app.
4. Tap the app and select "Always allow access to your location".

## Notice: Android Setup Tips

Allow Vegatouch Mira to access this device's location.

Mira will need to be allowed access to your location. Click ALLOW when you see this screen.

To enable Location Services on your Android device:

1. Open your phone's Settings app.
2. Tap Location/App Permission  
-If you don't see "Location" tap Security & Location/Location.  
-If you have a work profile, tap Advanced/Location.
3. Under "Allowed all the time" and "Allowed only while in use" view the apps that can use your phone's location, tap it, then choose the location access for the app.
4. To change the App's permissions, tap it, then choose the location access for the app.

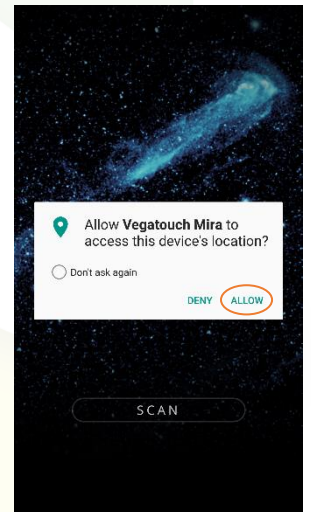

## App Settings:

Access the App Settings page by tapping the triangle (at the bottom of the screen) to expose the Settings button. Tap the gear to visit the settings page.

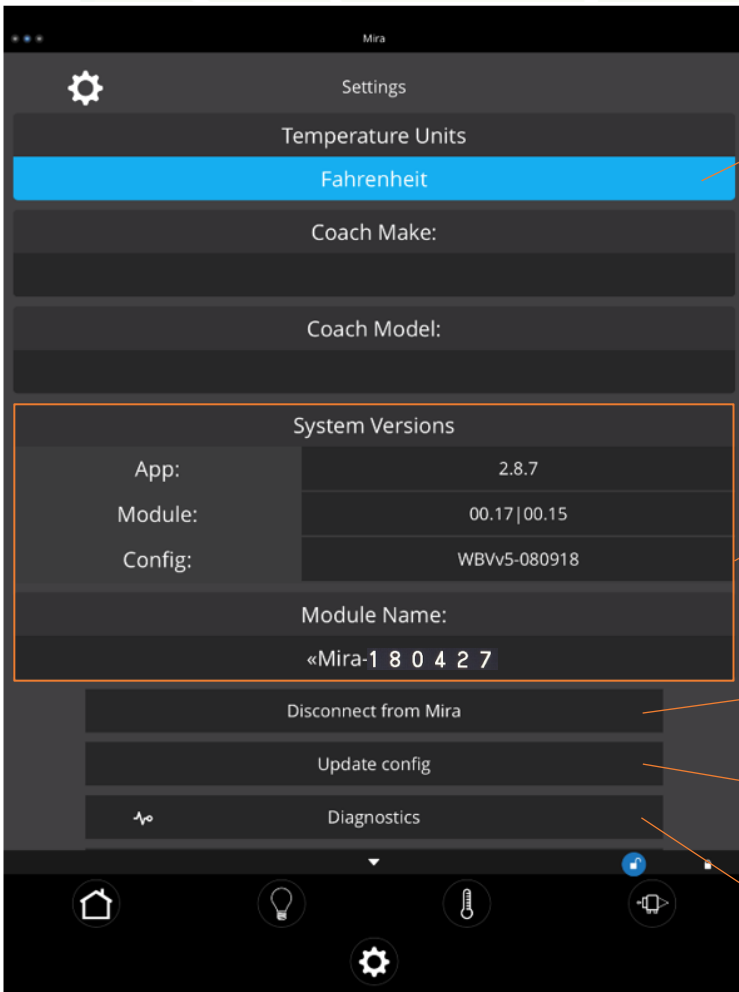
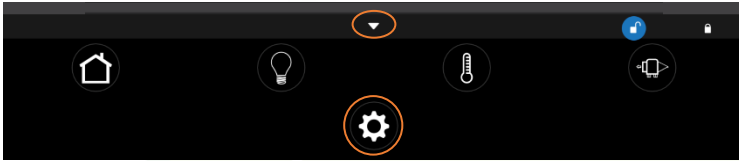

Tap the Temperature Units selection to choose between Fahrenheit and Celsius.

System Information and Mira Name.

Tap to disconnect your device from Mira.

Tapping Update Config will force a download of the config from the cloud.

Tap to enter the Diagnostic Tools screen.

## Diagnostic Tools:

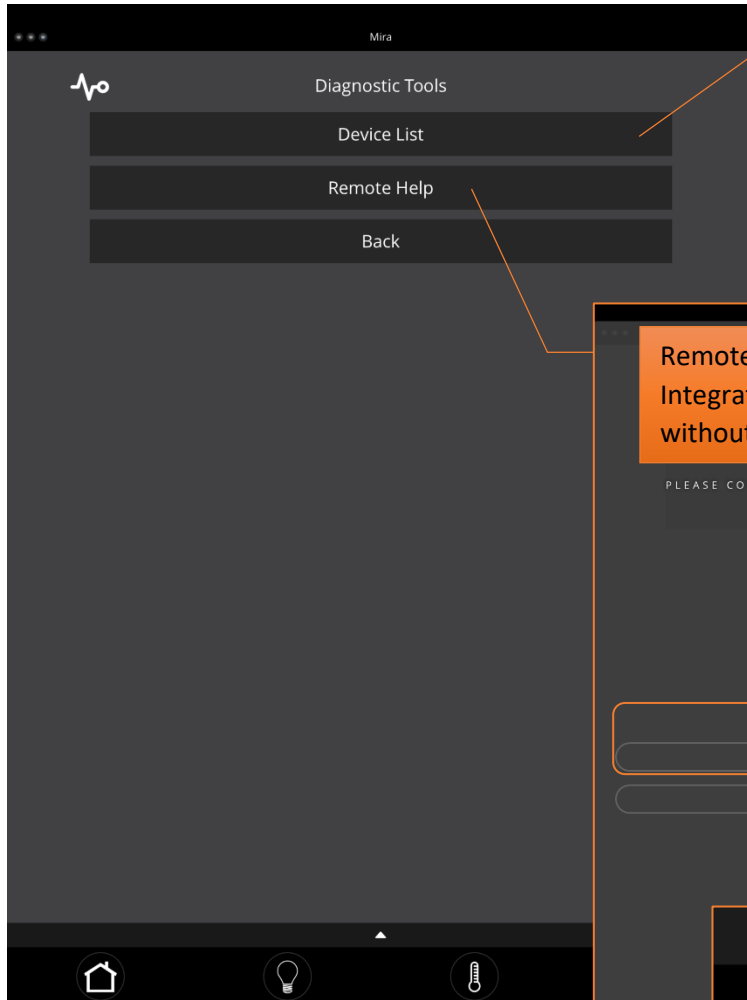

Tap to display a list of currently connected devices.

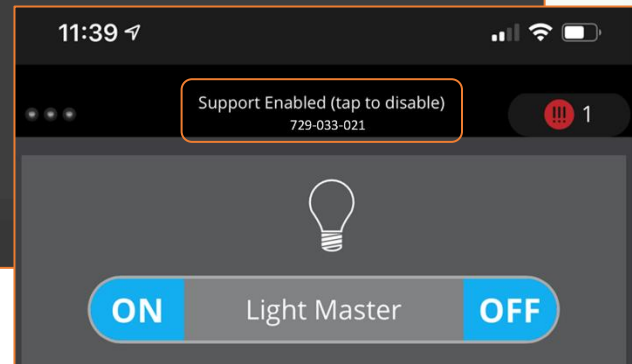
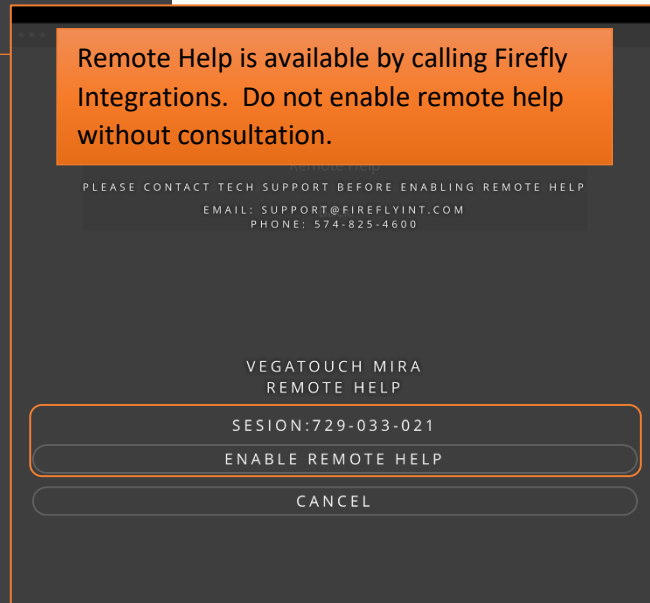

### Remote Help:

If instructed by Firefly, tap Enable Remote Help for advanced technical support. Once enabled, provide the Session ID to allow Firefly to remotely connect to your Mira app (internet connection required). To disable Remote Help, simply tap the Session ID number from the Home page of your Mira app.





## Settings/Switch Panel Info

The color-coded Wireless Graphic and Signal Strength Value will identify the status of a wireless switch panel.

- Green – Over 100 (Strong)
- Yellow – 85-100 (Medium)
- Red – Less than 85 (Weak)

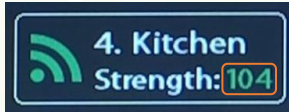

Red Wireless Graphic with a Zero reading – The switch is currently disconnected from the screen. It is likely that the battery inside your switch panel needs replaced. The wireless switch panel in your coach will illuminate a green LED whenever a button is pressed. If the LED on your switch panel does not illuminate when you press a button on your switch, you will need to replace the 2032 coin cell battery.

If the LED is illuminating but the switch still won't function, follow the pairing procedure on the next page.





# Wireless Switch Pairing

Red switch indicator with a zero reading – The switch is currently disconnected from the screen. It is likely that the battery inside your switch panel needs replaced. The wireless switch panel in your coach will illuminate a green LED whenever a button is pressed. If the LED on your switch panel does not illuminate when you press a button on your switch, you will need to replace the 2032 coin cell battery.

If a new battery will not fix the issue, you might need to pair the switch panel to the screen.

- 1 Tap the switch graphic for the switch panel you'd like to pair.
- 2 Tap Start Pairing. You'll have 30 seconds to press and hold any 2 buttons on the switch panel at the same time for 5 seconds.
- 3 Tap Done once the pairing successful message appears. It may take up to 10 minutes for the battery switch indicator to turn Green, but the switch should work instantly once paired. If at this point the switch still fails to work, press and hold the Clear button (not pictured) for 3 seconds and repeat the pairing procedure once again.

The screenshot displays the 'WIRELESS SWITCHES' app interface. At the top, the title 'WIRELESS SWITCHES' is shown in green, along with a warning icon and the time '7:01'. A sidebar on the left contains icons for home, power, light, temperature, speaker, and settings. The main area shows a floor plan with three switch panels labeled 1, 2, and 3. Panel 2 is selected, showing a red indicator and 'Strength: 0'. A hand icon points to panel 2. A 'START PAIRING' button is visible. Three dialog boxes are overlaid: 1. 'WIRELESS SWITCH PANEL PAIRING PROCEDURE' with 'PAIRED WIRELESS ID: FFD8070B' and instructions. 2. 'WIRELESS SWITCH PANEL PAIRING PROCEDURE' with 'PAIRING ACTIVE FOR: 19 SECONDS' and instructions. 3. 'WIRELESS SWITCH PANEL PAIRING SUCCESSFUL' with 'PAIRED WIRELESS ID: 0FD8070B' and a 'DONE' button. A 'START PAIRING' button is also visible with a '2' in an orange circle, and a 'DONE' button with a '3' in an orange circle.



# Settings/Network Diagnostics

## Firmware/Faults:

This screen will show the status of the Lyra screen and G12 panel. It will also display any current faults the system may be experiencing.

The screenshot shows the NETWORK DIAGNOSTICS screen at 7:01. It features a sidebar with navigation icons and a main content area. The main content area is divided into three sections: 7IN COLOR LCD, G12, and FAULTS. The 7IN COLOR LCD section shows Status (Online), Firmware Version (1.6), and Config Revision (1.4). The G12 section shows Status (Online), Firmware Version (1.2), and Config Revision (1.4). The FAULTS section lists three faults: Switch 2 has a dead battery or is disconnected, Switch 3 has a dead battery or is disconnected, and Switch 5 has a dead battery or is disconnected. An orange arrow points to the 'Online' status of the G12 section. At the bottom, there are three buttons: 'Firmware / Faults' (highlighted with an orange border), 'G12', and 'AirCon'.

## G12:

This screen will display all currently active G12 inputs and outputs.

The screenshot shows the NETWORK DIAGNOSTICS screen at 7:02. It features a sidebar with navigation icons and a main content area. The main content area is divided into three sections: G12, G12 INPUTS, and G12 OUTPUTS. The G12 section shows Status (Online), Firmware Version (1.2), and Config Revision (1.4). The G12 INPUTS section lists eight inputs: IN5 - Parking Brake, IN6 - Ignition, IN7 - Shore, and IN8 - Water Heater Fault. The G12 OUTPUTS section lists 24 outputs: 01 - Awning EXT, 02 - Awning RET, 03 - D/S Stabilizer UP, 04 - D/S Stabilizer DN, 05 - P/S Stabilizer UP, 06 - P/S Stabilizer DN, 07 - Slide Power, 08 - Tank Heaters, 09 - D/S Slide EXT, 10 - D/S Slide RET, 19 - Generator Start, 20 - Generator Stop, 21 - Living Ceiling, 22 - Kitchen Accent, 23 - Stove Lts, 24 - Slide Accent Lt, 25 - Awning Lts, 26 - Bed Ceiling, 27 - Bunk D/S Lt, 28 - Bunk P/S Lt, 29 - Bath Ceiling, 32 - Porch Lts, 33 - Scare Lts, 39 - Water Heater Gas, 40 - Water Heater Elec, 42 - Bath Fan, 43 - Furnace, and 44 - Water Pump. An orange arrow points to the 'Active Output' status of the G12 OUTPUTS section. At the bottom, there are three buttons: 'Firmware / Faults', 'G12' (highlighted with an orange border), and 'AirCon'.

**AirCon:**

This screen will show status of the AirCon modules.

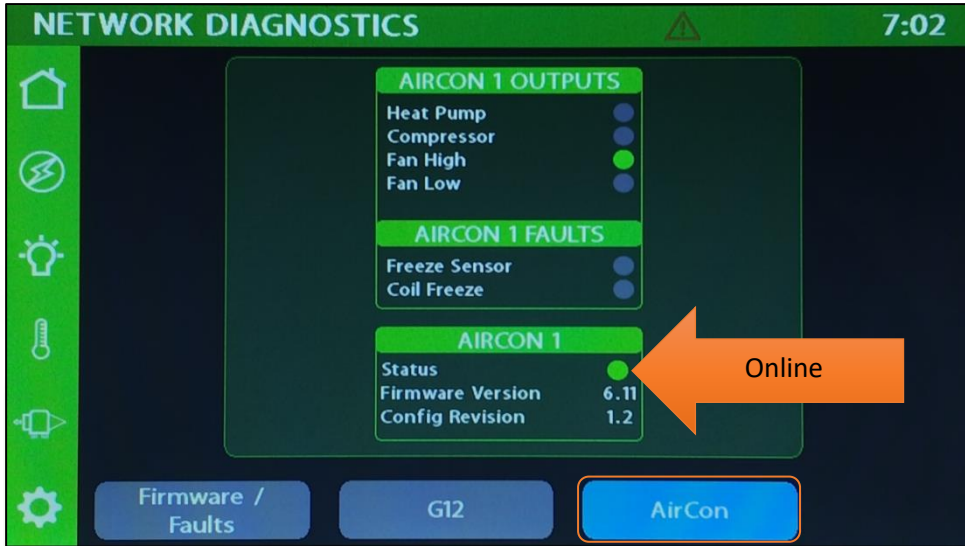





## Settings/Display Colors

Tap from the selections below to select a preset color scheme for your touchscreen. Once selected, tap Apply to save and exit.

Currently selected option.

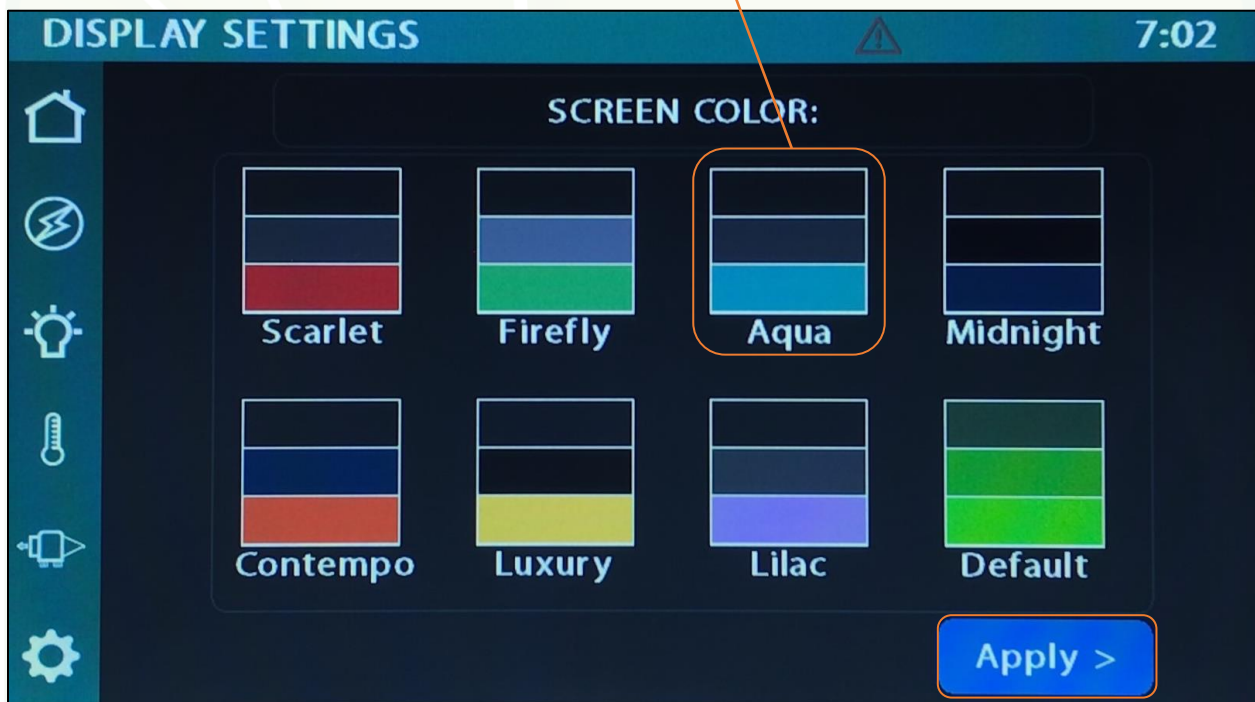



# Settings/Options

From the Settings page, press and hold the Floorplan display for 5 seconds. Once you lift your finger, the Options page will appear.

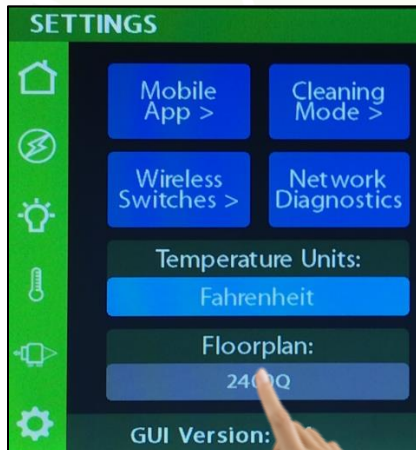

Tap to select the required floorplan and necessary options. Tap Apply to save and exit.





# Overcurrent Detection



If an output on the G12 experiences an overcurrent fault, a lightning bolt graphic will appear at the top of the screen. Tapping the Lightning Bolt graphic will result in a Warning screen with a brief set of instructions. From this screen, tap Continue to navigate to the Diagnostics screen.

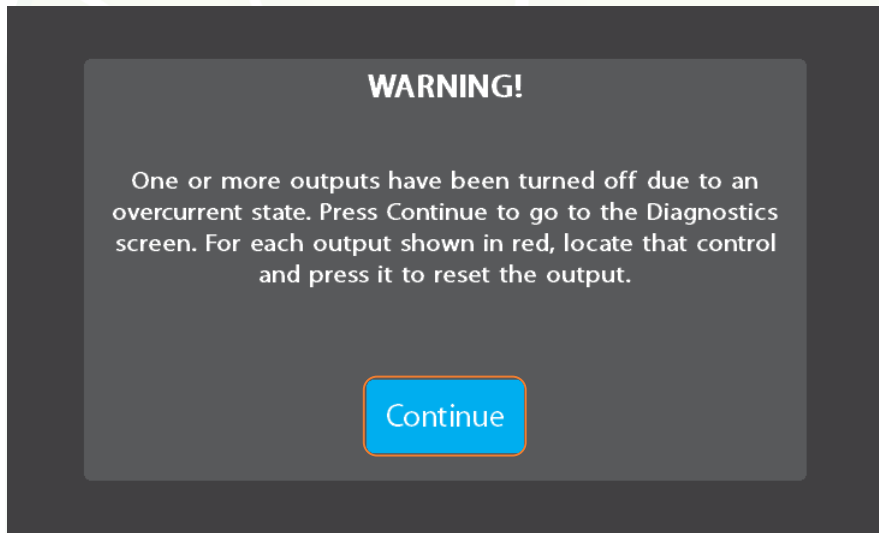

The Network Diagnostics screen will use red lights to alert you of overcurrent detections. To clear the faults, navigate to each faulted control and tap them to reset. Note – you'll notice that their buttons have turned red and will remain that way until cleared.

**NETWORK DIAGNOSTICS** 7:02

**G12**

Status ●  
Firmware Version 1.2  
Config Revision 1.4

**G12 INPUTS**

- IN5 - Parking Brake ●
- IN6 - Ignition ●
- IN7 - Shore ●
- IN8 - Water Heater Fault ●

**G12 OUTPUTS**

01 - Awning EXT ●	23 - Stove Lts ●
02 - Awning RET ●	24 - Slide Accent Lt ●
03 - D/S Stabilizer UP ●	25 - Awning Lts ●
04 - D/S Stabilizer DN ●	26 - Bed Ceiling ●
05 - P/S Stabilizer UP ●	27 - Bed D/S Lt ●
06 - P/S Stabilizer DN ●	28 - B ●
07 - Slide Power ●	29 - B ●
08 - Tank Heaters ●	32 - P ●
09 - D/S Slide EXT ●	33 - S ●
10 - D/S Slide RET ●	39 - V ●
19 - Generator Start ●	40 - V ●
20 - Generator Stop ●	42 - B ●
21 - Living Ceiling ●	43 - F ●
22 - Kitchen Accent ●	44 - V ●

RED = Overcurrent Fault

Stove Light ●  
Slide Accent ●

Tap to reset.

Firmware / Faults G12 AirCon



## SSP17 Switch Panels

Your coach uses SSP17 switch panels to control lighting and other functions. Lights that are dimmable will have Up/Down arrows next to the icon. Press and hold these buttons to ramp the brightness up and down.

SSP17 switch panels use wireless RF technology to communicate with the Lyra touchscreen. These switches are powered by a 2032-coin cell battery. If you press a switch panel button and the operational LED does not illuminate, you'll need to change the battery. Simply use your fingers to pry the switch panel away from the wall-mounted backplate to access the battery compartment on the back of the switch.

Once you replace the battery, line the switch panel up with the backplate and apply pressure to snap the switch panel back into place.

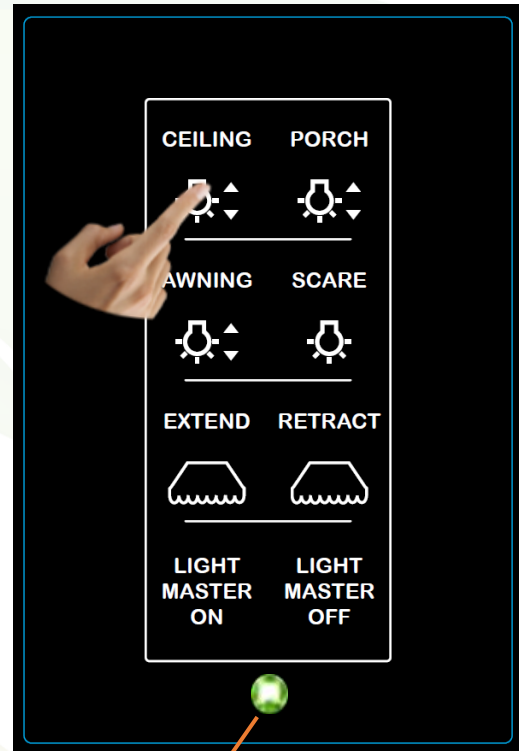

Operational LED



Slide the battery up to remove.



# G12 DC Panel

Your G12 control panel is the power distribution center for the coach. This panel receives the signals sent from your touchscreen/switch panels and performs the actions that have been requested by activating and deactivating the required circuits.

Every circuit controlled by the G12 is numbered and listed on a black label (load list) which is usually mounted next to the G12 panel. Note: The G12 will not have individual illuminated NET LED's for each channel. For instance, if you press the Slide Accent light button on your touchscreen, there will be no illuminated GREEN LED to show that it is currently operational. Check the Network Diagnostics Page to see if the output shows status. If it does, you will want to check output voltage on that pin if the light doesn't come on (Fig 1).



Figure 1

Test **Positive** Output Channels as shown:

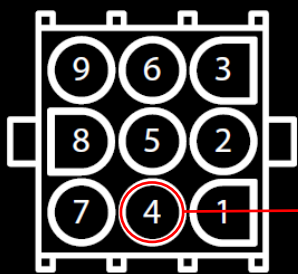

### J3: HC OUTPUTS 12A; LC 6A

- Pin 1 (Out 21): Living Ceiling LTS (6A)
- Pin 2 (Out 22): Kitchen Accent LT
- Pin 3 (Out 23): Stove LT
- Pin 4 (Out 24): Slide Accent LT**
- Pin 5 (Out 25): Awning LTS
- Pin 6 (Out 26): Bed Ceiling LTS
- Pin 7 (Out 27): Bunk D/S LT
- Pin 8 (Out 28): Bunk P/S LT
- Pin 9 (Out 29): Bath Ceiling LTS





# Networking

Your distribution panel and touchscreen connect via your coach's RV-C network. Each component will have a NET LED that is used to show network status. If a NET LED is displaying anything other than solid green and some of the panel's functions are not working, please use the keys below to determine the network status of your hardware.

## Net LED Locations:

G12 Panel



Back of Touchscreen















## Network Status Indicators

Every component of the Firefly system uses an LED to communicate network status. Use the key below to determine the network status of your hardware. \*

### Panel Network Status Indicator – Applies to any device with a network indicator:

-  /  Fast flashing Green Light (4 times/sec) – Device is attempting to make initial connection.
-  /  Slow flashing Green Light (1 time/sec) – Device was online but has been offline for at least 5 sec.
-  Solid Green – Device is connected to network and is communicating properly.
-  Solid Red – Device has gone offline and is not connected to a network.
-  /  Alternating Red & Orange – Device has gone offline and is trying to re-connect (within 30 sec).
-  /  Alternating Green & Orange – Device is currently online but has gone offline 2 or more times

\*Note: Mira modules use a different networking key. Please see the next page.



# Mira NET LED Status Key

The NET LED on your Mira module can change color in different situations. Use the following key to determine the operational status of your module.

	Off	Device has no power or has completely failed
	Fast flashing green (4 times/sec)	Device is attempting to make initial connection to the CAN network and good files
	Solid green	Device is operating correctly and has seen a CAN message in the past 5 seconds and good files
	Slow flashing green (1 time/sec)	Device was active on the CAN bus but has not seen a valid message in 5 seconds and good files
	Alternating red and yellow	Device has not seen CAN messages in 30 seconds and good files
	Alternating yellow and green	Device is currently active on the CAN bus but has not seen a CAN message within a 30s interval 2 for more times since the last power cycle and good files
	Solid red	Device has not seen a CAN message in the past 60 seconds and good files
	Fast alternating green and blue (4 times/sec)	Device is attempting to make initial connection to the CAN network and corrupted files
	Solid blue	Device is operating correctly and has seen a CAN message in the past 5 seconds and corrupted files
	Slow alternating green and blue (1 time/sec)	Device was active on the CAN bus but has not seen a valid message in 5 seconds and corrupted files
	Alternating red and blue	Device has not seen CAN messages in 30 seconds and corrupted files
	Alternating yellow and blue	Device is currently active on the CAN bus but has not seen a CAN message within a 30s interval 2 or more times during a power cycle and corrupted files
	Solid purple	Device has not seen a CAN message in the past 60 seconds and corrupted files
	Flashing white	Device pin is being reset
	Solid yellow	Device pin has been reset
	Flashing blue	Device does not have a valid application
	Flashing red (2 seconds)	Factory test: Red LED
	Flashing green (2 seconds)	Factory test: Green LED
	Flashing blue (2 seconds)	Factory test: Blue LED

# G12 Master

Log In:

Customer: FOREST RIVER Model: FORESTER Revision: 1V9

Raw Part: 7000701 G12 w/TruTank Custom Part: 28500001 Date: 07/22/20 AG

Outputs: 1-44 Program Version: \_\_\_\_\_

J4: HIGH CURRENT OUTPUTS 12A; LOW CURRENT 6A				
Pin	Out	Load	AMP	O/C
1	30		4A	.27s
2	31		4A	.27s
3	32	PORCH LTS (DIM)	4A	.27s
4	33	SCARE LTS (NON-DIM)	4A	.27s
5	34		4A	.27s
6	35		4A	.27s
7	36		4A	.27s
8	37		4A	.27s
9	38		4A	.27s
10	39	WATER HEATER GAS	4A	.27s
11	40	WATER HEATER ELECTRIC	4A	.27s
12	41		4A	.27s
13	42	BATH FAN (12V) (LATCHING)	10A	.27s
14	43	FURANCE	4A	.27s
15	44	WATER PUMP	12A	2.1s

J12: THERMISTORS	
Pin	Load
1	THERMISTOR 1
2	
3	
4	
5	
6	
7	THERMISTOR 1 GND
8	
9	
10	
11	
12	

J11: TANKS	
Pin	Load
1	FRESH (TRUTANK)
2	GREY (TRUTANK)
3	BLACK COMP 1 (TRUTANK)
4	BLACK COMP 2 (TRUTANK)
5	
6	
7	
8	
9	FRESH (GND)
10	GREY (GND)
11	BLACK COMP 1 (GND)
12	BLACK COMP 2 (GND)
13	
14	
15	
16	

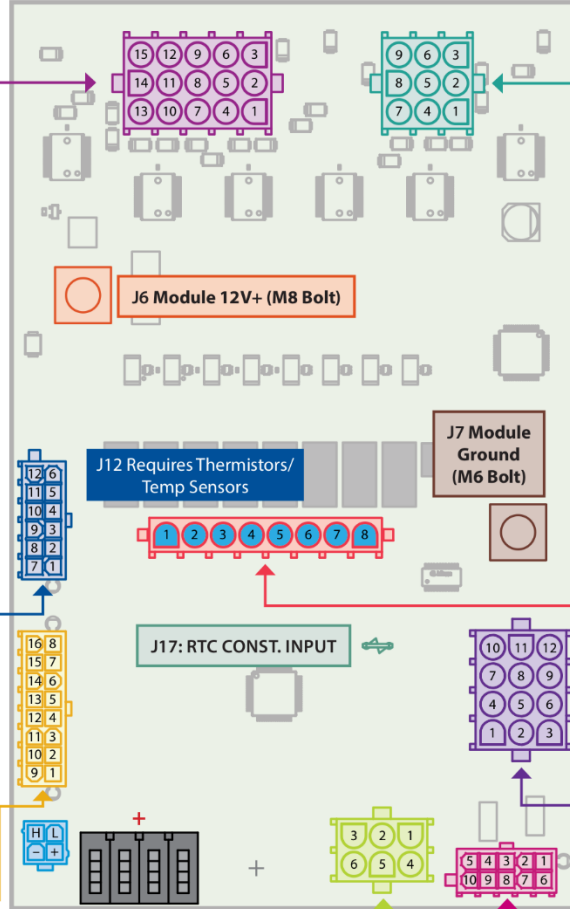

J13: LPG	
Pin	Load
1	LP GAS SIG
2	
3	CHASSIS (12V)
4	LP GAS GND
5	
6	GEN RUN (12V)

J3: HIGH CURRENT OUTPUTS 12A; LOW CURRENT 6A				
Pin	Out	Load	AMP	O/C
1	21	LIVING CEILING LTS (DIM)	6A	.27s
2	22	KITCHEN ACCENT LT (DIM) (PROTC	4A	.27s
3	23	STOVE LT (DIM) (PROTO OPTION)	4A	.27s
4	24	SLIDE ACCENT LT (DIM) (PROTO OI	4A	.27s
5	25	AWNING LTS (DIM)	4A	.27s
6	26	BED CEILING LTS (DIM)	4A	.27s
7	27	BUNKD/SLT (DIM)	4A	.27s
8	28	BUNKP/SLT (DIM)	4A	.27s
9	29	BATH CEILING LTS (DIM)	4A	.27s

J8: HIGH CURRENT RELAYS (20A MAX)				
Pin	Out	Load	AMP	O/C
1	1	AWNING EXTEND (RP)	15A	.51s
2	2	AWNING RETRACT (RP)	15A	.51s
3	3	D/SSTABILIZER UP (RP)	15A	.51s
4	4	D/SSTABILIZER DOWN (RP)	15A	.51s
5	5	P/SSTABILIZER UP (RP)	15A	.51s
6	6	P/SSTABILIZER DOWN (RP)	15A	.51s
7	7	SLIDE POWER	20A	.26s
8	8	TANK HEATERS (LATCHING)	20A	1.0s

J10: HALF BRIDGES 1A (PROGRAMMABLE POLARITY)				
Pin	Out	Load		+/-
1	9	D/SSJIDE EXTEND		+
2	10	D/SSJIDE RETRACT		+
3	11			+
4	12			+
5	13			+
6	14			+
7	15			+
8	16			+
9	17			+
10	18			+
11	19	GENERATOR START (30 SEC PULSE)		-
12	20	GENERATOR STOP (30 SEC PULSE)		-

J5: INPUTS		
Pin	Load	+/-
1		-
2		-
3		-
4		-
5	PARKING BRAKE	-
6	IGNITION	+
7	SHORE SENSE	+
8	WATER HEATER FAULT	+
9		+
10		+

Add Placeholders

Pin Legend: ■ Reverse Polarity

# G12 Master

Log In:

Customer: FOREST RIVER Model: FORESTER Revision: V1

Raw Part: \_\_\_\_\_ Custom Part: \_\_\_\_\_ Date: 07-21-2020

Outputs: 1-44 Program Version: \_\_\_\_\_

J4: HIGH CURRENT OUTPUTS 12A; LOW CURRENT 6A					
Pin	Out	Load	AMP	O/C	
1	30				
2	31				
3	32	RED W/ STRIPE (PORCH LTS)			
4	33	GREEN (SCARE LTS)			
5	34				
6	35				
7	36				
8	37				
9	38				
10	39	ORANGE (WATER HEATER GAS)			
11	40	WHITE (WATER HEATER ELECTRIC)			
12	41				
13	42	YELLOW ( BATH FAN)			
14	43	FURNACE (FURNACE)			
15	44	WATER PUMP (WATER PUMP)			

J12: THERMISTORS	
Pin	Load
1	BLACK (THERMISTOR#1)
2	
3	
4	
5	
6	
7	BLACK W/ STRIPE (THERMISTOR31)
8	
9	
10	
11	
12	

J11: TANKS	
Pin	Load
1	BLUE (FRESH TANK)
2	GREY (GREY TANK)
3	BROWN ( BLACK TANK #1)
4	BLACK ( BLACK TANK #2)
5	
6	
7	
8	
9	BLUE W/ STRIPE (FRESH TANK)
10	GREY W/ STRIPE (GREY TANK)
11	BROWN W/ STRIPE (BLACK TANK #1)
12	BLACK W/ STRIPE (BLACK TANK #2)
13	
14	
15	
16	

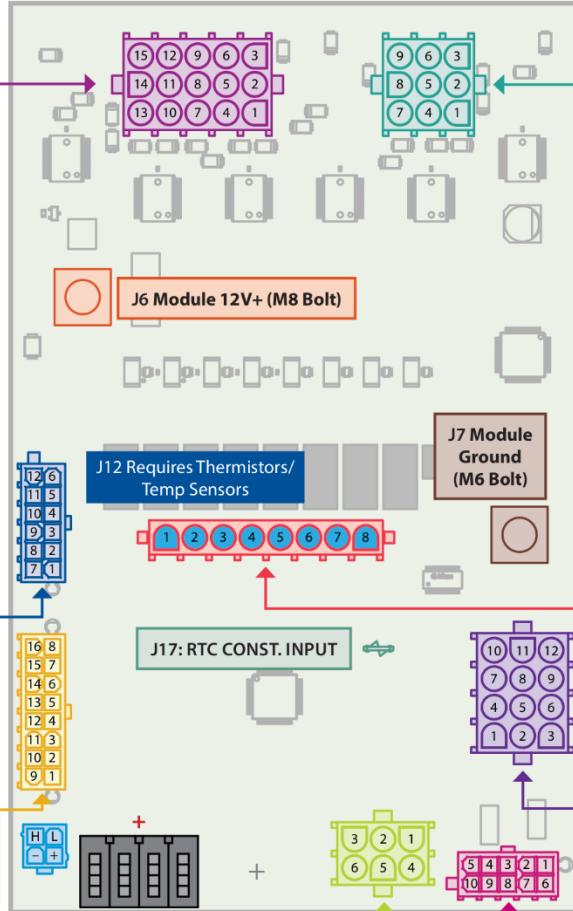

J13: LPG	
Pin	Load
1	ORANGE (LP GASSIG)
2	
3	PINK (CHASSIS)
4	WHITE (LP GAS)
5	
6	BLUE (GEN RUN)

J3: HIGH CURRENT OUTPUTS 12A; LOW CURRENT 6A					
Pin	Out	Load	AMP	O/C	
1	21	BROWN (LIVING CEILING LIGHTS)			
2	22	GREY (KITCHEN ACCENT)			
3	23	BLUE W/ STRIPE (STOVE LIGHTS)			
4	24	RED W/ STRIPE (SLIDE ACCENT)			
5	25	BLACK (AWNING LIGHTS)			
6	26	BLUE (BED CEILING)			
7	27	RED (BUNK D/SLTS)			
8	28	GREEN (BUNK P/SLTS)			
9	29	PURPLE (BATH CEILING LTS)			

J8: HIGH CURRENT RELAYS (20A MAX)					
Pin	Out	Load	AMP	O/C	
1	1	YELLOW (AWNING EXTEND)			
2	2	YELLOW W/ STRIPE (AWNING RET)			
3	3	PURPLE (D/S STABILIZER UP)			
4	4	PURPLE W/ STRIPE (D/S STAB DWN)			
5	5	GREEN (P/S STABILIZER UP)			
6	6	GREEN W/ STRIPE (P/S STAB DWN)			
7	7	RED (SLIDE PWR)			
8	8	BLACK W/ STRIPE (TANK HEATER)			

J10: HALF BRIDGES 1A (PROGRAMMABLE POLARITY)				
Pin	Out	Load		+/-
1	9	GREY (D/S SLIDE EXTEND)		+
2	10	RED (D/S SLIDE RETRACT)		+
3	11			+
4	12			+
5	13			+
6	14			+
7	15			+
8	16			+
9	17			+
10	18			+
11	19	RED (GEN START)		+
12	20	GREEN (GEN STOP)		+

J5: INPUTS		
Pin	Load	+/-
1		-
2		-
3		-
4		-
5	WHITE (PARKING BRAKE)	-
6	ORANGE (IGNITION)	+
7	BROWN (SHORE SENSE)	+
8	BLUE (WATER HEATER FAULT)	+
9		+
10		+

Add Placeholders

Pin Legend: ■ Reverse Polarity





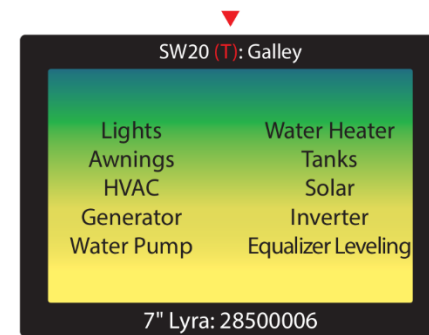
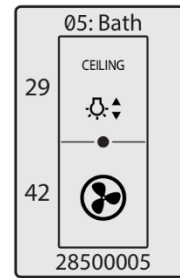
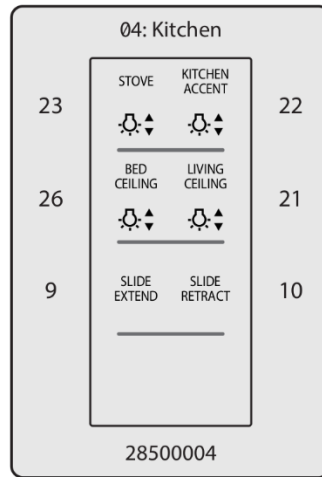
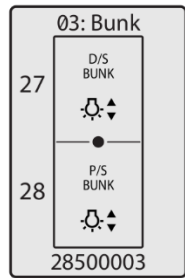
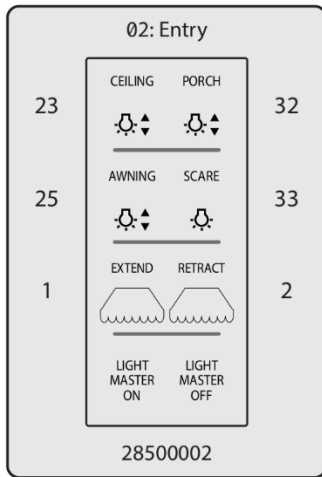
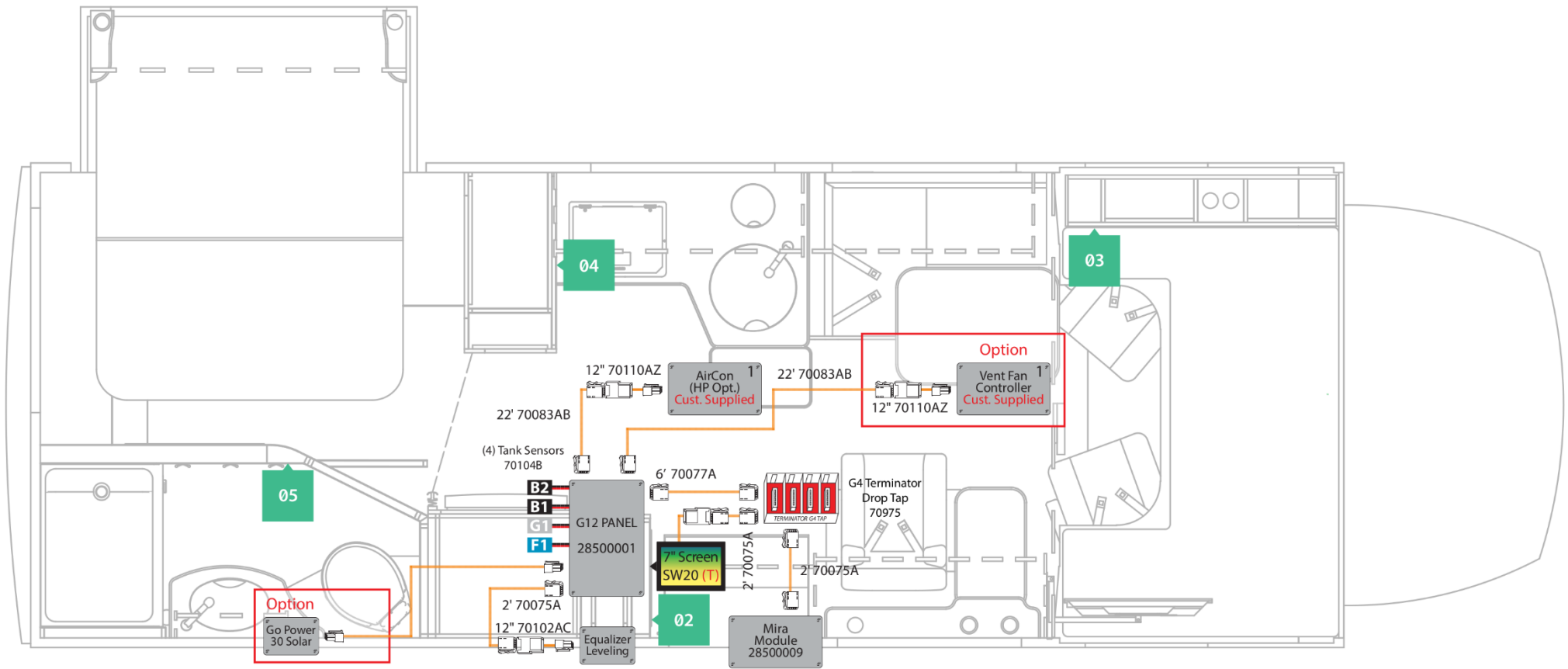

<b>Forester 2401Q</b>			DI: MD/AG	<b>Network Legend</b>		<b>Wire Labels</b> 
Network Wiring Diagram and Switch Panel Layout						
SSP-17 RFB, Lyra	NWD REV 1v6	07/28/20		Trunk Cable ——— Drop Cable ——— Switch Position —■— ← T		

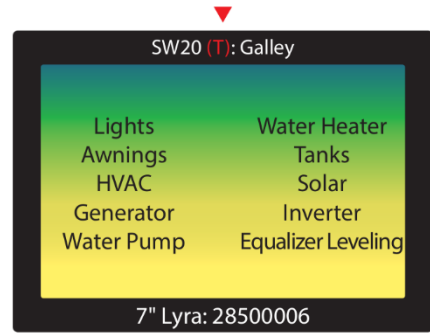
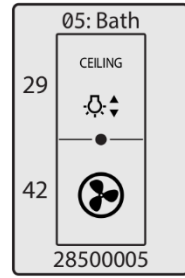
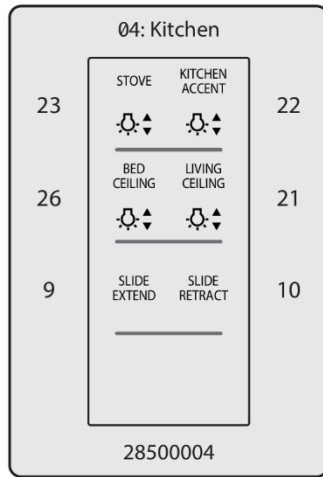
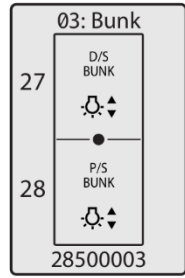
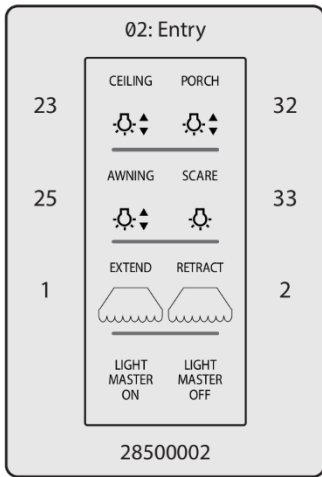
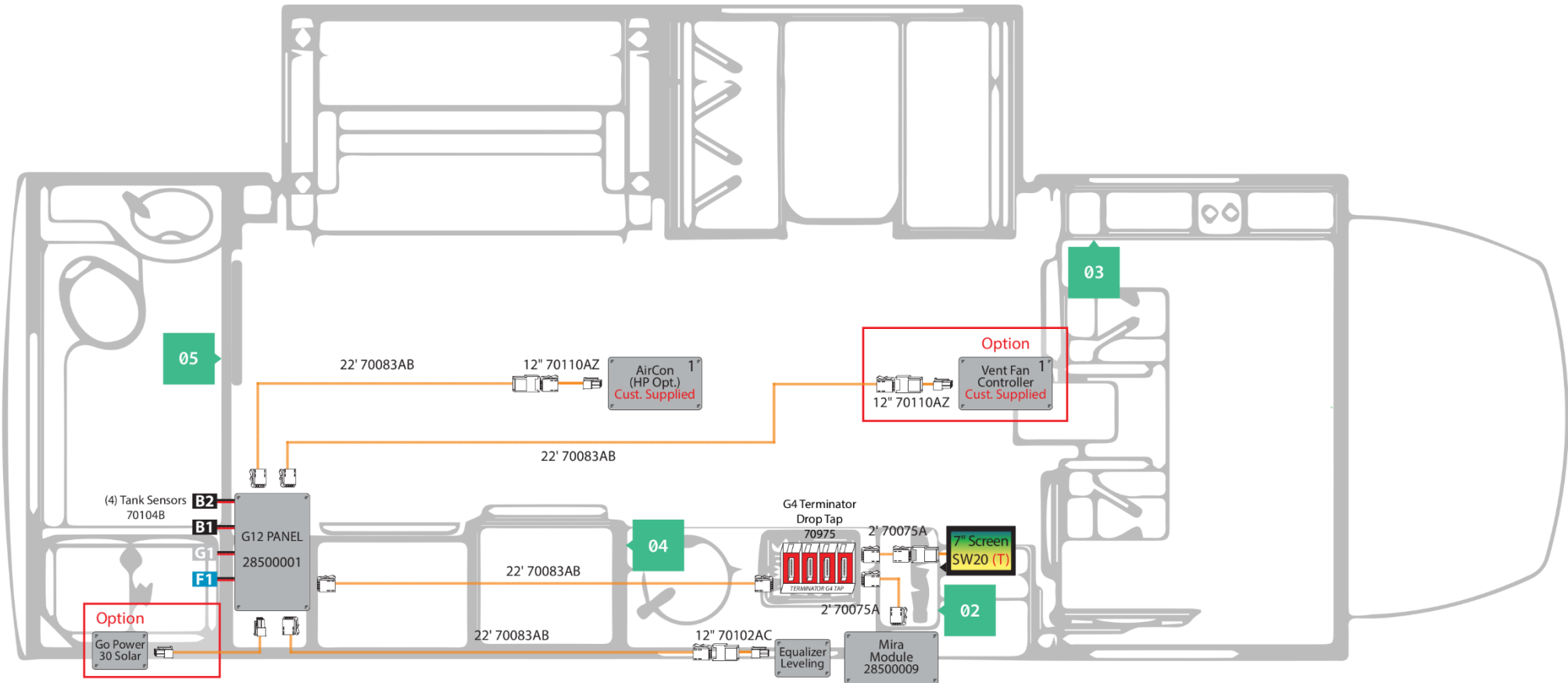

<b>Forester - MBS 2400T</b>			<b>DI: MD/AG</b>		<b>Network Legend</b>		Drop Plug (Rear)	Mini Molex Plugs (Rear)	<b>Wire Labels</b> PWR GND CAN-H CAN-L
Network Wiring Diagram and Switch Panel Layout									
SSP-17 RF/RFB, Lyra			NWD REV 1v12 07/28/20		Drop Cable				
			PI: **		Switch Position   ← T				