

Roadster





Enjoying the Journey.....



SERVICE, PARTS & WARRANTY BUILDING



PLANT TWO



MAIN HEADQUARTERS- PLANT ONE

On a Mission

At Open Range RV, we are on a mission to...

Fulfill the trailer needs of our dealer base and retail customers, and in doing so, exceed their expectations for service, quality and value.

Earn our dealers', retail customers' and employees' long-term loyalty by delivering more than we promise, in a fair and honest business manner.

Motivate our employees to provide exceptional service and quality to our retail customers and dealers.

Compensate our employees fairly and provide opportunity for personal growth within our company.

Although it is our goal to provide a product that exceeds our customer needs and level of quality, we do not strive to be the biggest or the most profitable. In the end, we believe satisfied customers, dealers and employees will bring growth and long term profitability for all.

For almost 30 years, I have had the great fortune to work in the amazing industry of RV manufacturing. This industry runs through my blood and is the passion of my life. This has been a dream come true for me and my family. I would like to thank everyone who believed in us as an RV Manufacturer. At Open Range our motto is ENJOY THE JOURNEY!

It has been an amazing JOURNEY so far! Come join us on this great JOURNEY, we don't want you to miss another moment of it.

Enjoy the Journey!

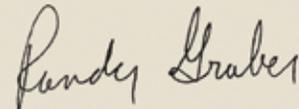

Randy Graber, President
Open Range RV Company

Roamer Fifth Wheels



Model RF329BHS Living Room in Lifelong Decor

PULL OUT PANTRY



- Conveniently Placed in Kitchen
- Space Saving Size and Build
- Ball Bearing Guides for Easy Access
- 3-Tiers for Maximum Storage

CORIAN COUNTERTOPS WITH FLUSH MOUNTED SINK COVERS



- Durable Finish for Years of Use
- Nonporous Surface - Easy to Clean
- Easy Repair if Damaged
- Stainless Steel Sink
- Single Lever Pullout Spray Faucet

REVERSIBLE SOFA CUSHIONS





Model RF329BHS Bedroom in Lifelong Decor



EXTRA DEEP CHEST OF DRAWERS



***RADIUS BED BASE WITH
TONS OF STORAGE***

- Easy Lift Strut Assist
- Radius Base for Easy "Walk Around"
- Full Depth Base to Fit all Your Items

- 100 lb. Ball Bearing Drawer Guides
- Full Extension for Easy Access
- Drawer Bottom Support Brace for Quality that Lasts

Fifth Wheel Floorplans





RF357RES



RF395BHS

	GVWR	UVW	Hitch Wt.	Axle Wt.	Gross NCC	Ext. Length	Ext. Height	Ext. Width	Water Heater Gas/Elec	Fresh Water	Gray Water	Waste	LP Gas (Lbs)	Furnace (BTU's)	Tire Size	Awning Size
RF316RLS	10935	8565	2135	6430	2370	30'10"	155"	100"	10 Gal	85	82	41	80	35,000	15"/16" Opt	19'
RF329BHS	12145	8735	1745	6990	3410	34'	155"	100"	10 Gal	85	82	41	80	35,000	15"/16" Opt	18'
RF337RLS	12340	8825	1940	6885	3515	33'6"	155"	100"	10 Gal	85	57	41	80	35,000	15"/16" Opt	16'
RF338RLS	12455	9625	2055	7570	2830	35'	155"	100"	10 Gal	85	82	41	80	35,000	15"/16" Opt	16'
RF357RES	12575	9545	2175	7370	3030	35'2"	155"	100"	10 Gal	85	57	41	80	35,000	15"/16" Opt	16'
RF395BHS	TBD	TBD	TBD	TBD	TBD	39'4"	155"	100"	10 Gal	85	74	74	80	40,000	15"/16" Opt	16'

Roamer Travel Trailers



Model RT281FLR Living Room in Pinto Decor



Model RT281FLR Bedroom in Pinto Decor



EXTRA DEEP CHEST OF DRAWERS



***RADIUS BED BASE WITH
TONS OF STORAGE***

- Easy Lift Strut Assist
- Radius Base for Easy "Walk Around"
- Full Depth Base to Fit All Your Items

- 100 lb. Ball Bearing Drawers Guides
- Full Extension for Easy Access
- Drawer Bottom Support Brace for Quality that Lasts

Travel Trailer Floorplans



RT247FLR

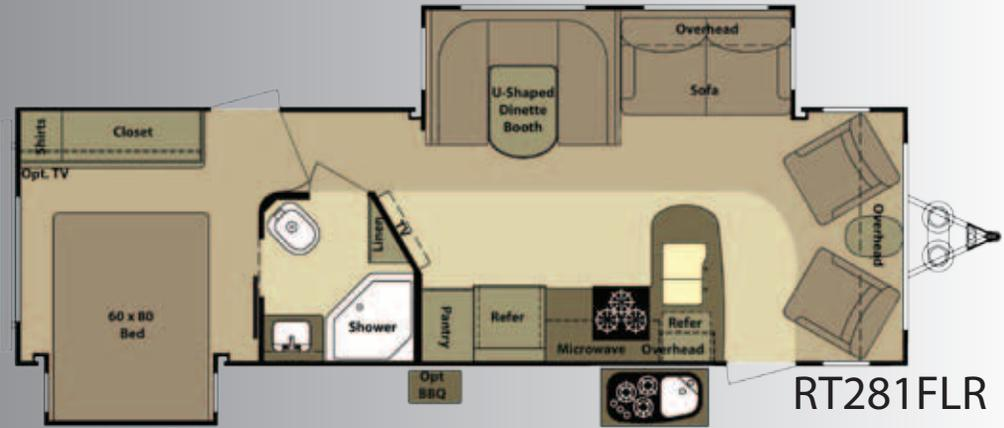

RT281FLR

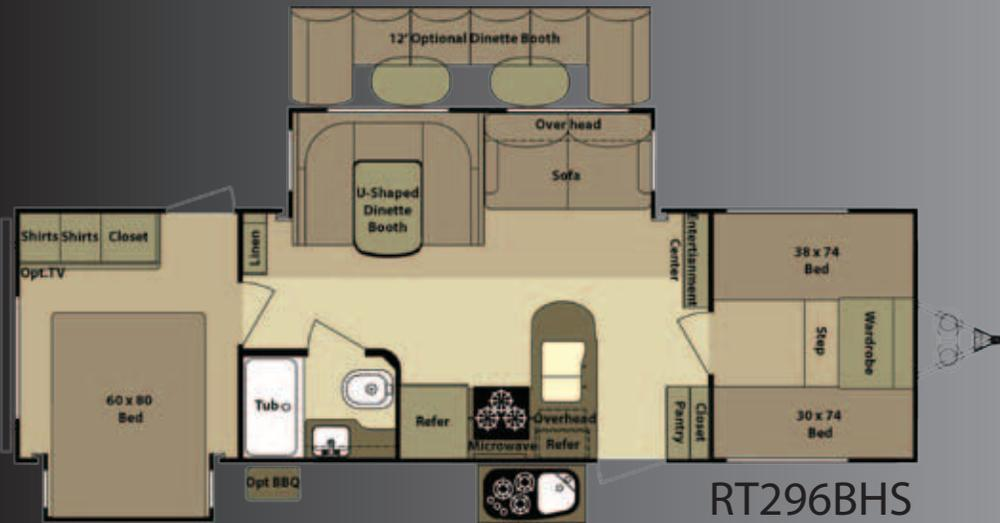

RT296BHS



RT303BHS

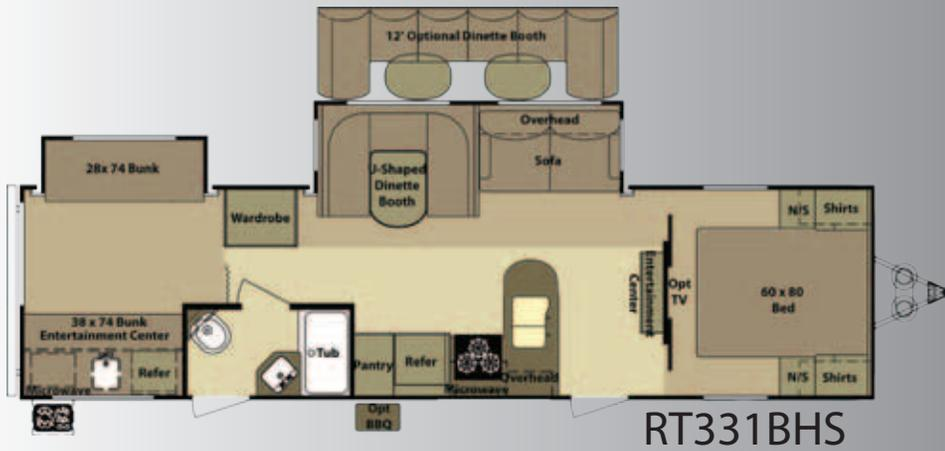

	GVWR	UVW	Hitch Wt.	Axle Wt.	Gross NCC	Ext. Length	Ext. Height	Ext. Width	Water Heater Gas/Elec	Fresh Water	Gray Water	Waste	LP Gas (Lbs)	Furnace (BTU's)	Tire Size	Awning Size
RT247FLR	8520	6545	850	5695	1975	29'	140"	100"	6 Gal	50	60	30	60	30,000	15"	15'
RT281FLR	8755	6780	910	5870	1975	32'	140"	100"	6 Gal	50	60	30	60	30,000	15"	16'
RT296BHS	9090	7115	730	6385	1975	33'	140"	100"	6 Gal	50	60	30	60	30,000	15"	16'
RT303BHS	9090	7115	745	6370	1975	33'	140"	100"	6 Gal	50	60	30	60	30,000	15"	19'
RT316RLS	9990	7745	1290	6455	2245	33'8"	140"	100"	6 Gal	50	57	30	60	30,000	15"	19'
RT320RES	9990	7570	845	6725	2420	34'6"	140"	100"	6 Gal	50	60	30	60	30,000	15"	16'
RT331BHS	9990	7505	640	6865	2485	36'8"	140"	100"	6 Gal	50	60	30	60	30,000	15"	15'

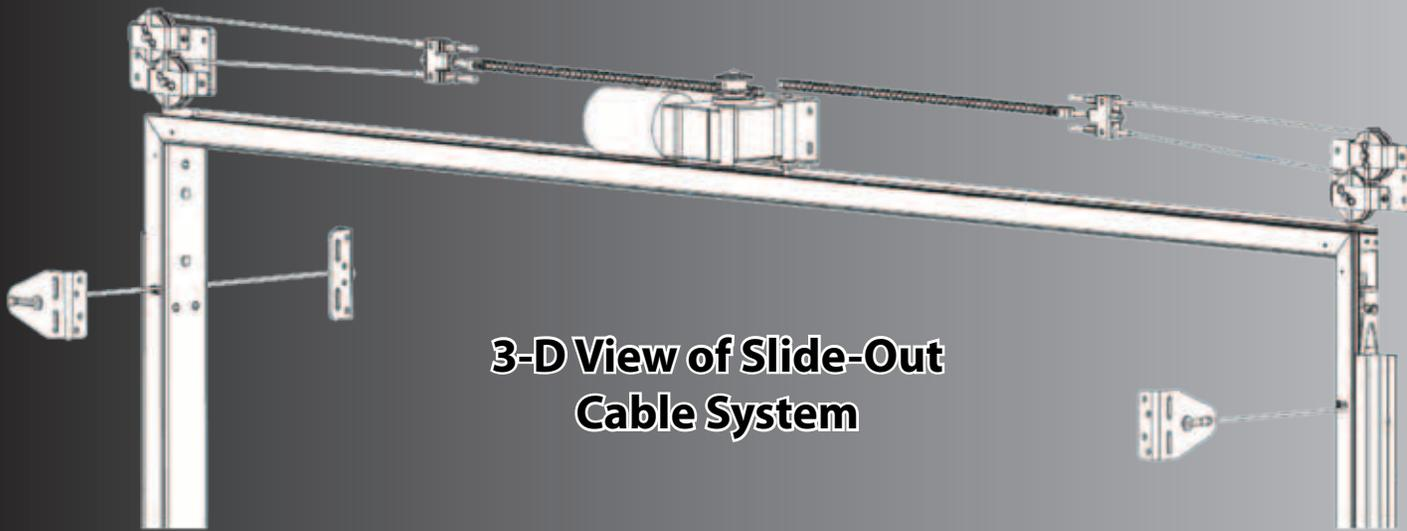

3-D View of Slide-Out Cable System

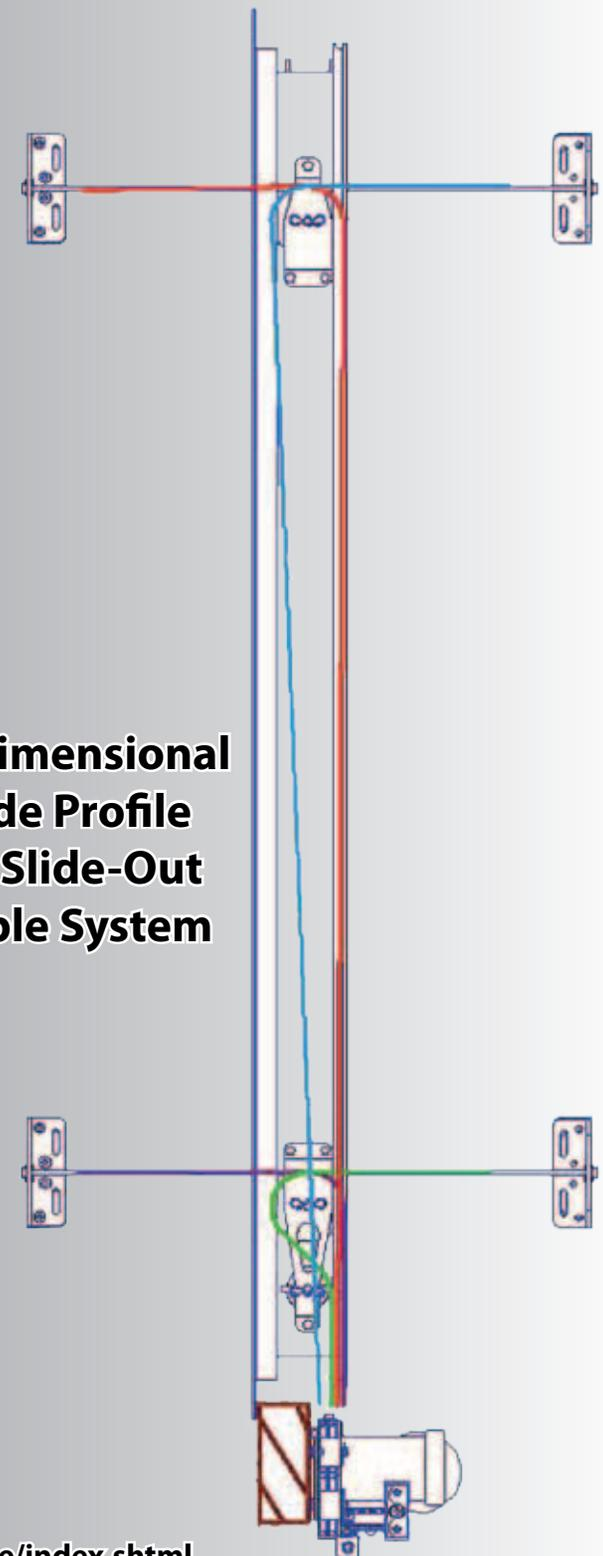

1- Dimensional Side Profile Of Slide-Out Cable System

10 Reasons Why... Accu-Slide

1. Above floor design means more storage area for your RV
2. Lightweight design promotes fuel savings
3. High strength stainless steel aircraft cable is used for control
4. Cable control at all 4 room corners helps stop leaks
5. Working components are in your RV, safe from the elements
6. Locking motor secures room in or out to help stop leaks
7. Above floor design minimizes maintenance requirements
8. A clean system - no leaky hydraulic lines or greasy drives
9. Smooth, quiet room movement - no jumping or jerking
10. It's built in the U.S.A. and backed by BAL since 1972

Construction Cutaway

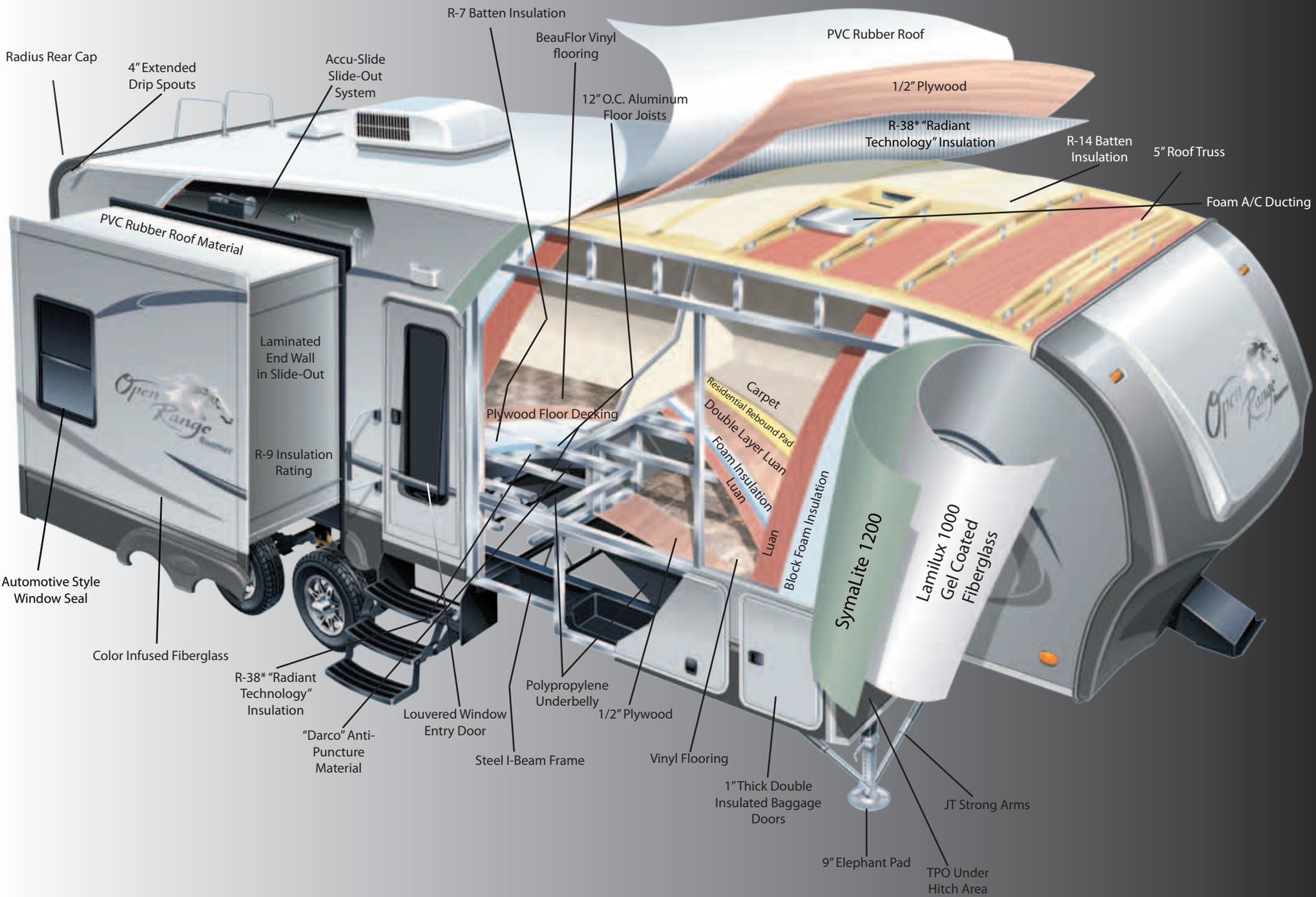

Interior Construction

**100 LB. FULL EXTENSION
DRAWER GUIDES**



CABINET CONSTRUCTION



- Face Frames are Tube Drilled and Screwed for Maximum Strength

HARDWOOD CABINET CONSTRUCTION



- Hardwood Cabinet Door Frames & Drawer Faces
- Lumber Core Stiles
- Mortis & Tenon Joints
- Residential Style Hidden Hinges

7-LAYER BEAUFLOL VINYL FLOORING

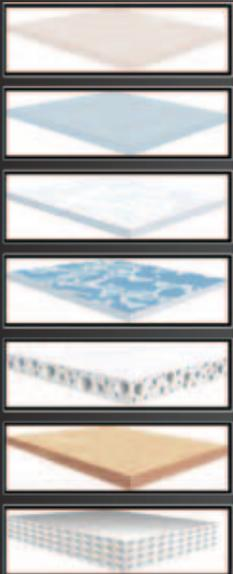

**MORTIS & TENON CABINET
CONSTRUCTION**

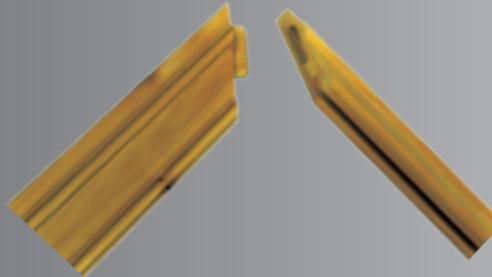

HIDDEN HINGES



- Elegant Euro-Style Spring Loaded Hardware
- Keeps Doors Closed Tightly
- Fully Adjustable to Customized Fit

Exterior Construction

1/2" PLYWOOD ROOF DECKING

- 1/2" Thick Plywood
- 350 lb. Rating
- Constructed with Real Plywood
- More Durable
- Better Quality



- Ultra Violet Resistant
- No Streaking or Chalking
- No Reconditioning Needed
- 30% Lighter Weight Than EPDM Rubber Roof
- Self Extinguishing
- Can be Recycled

PVC RUBBER ROOF MATERIAL



SYMALITE 1200 SIDEWALL SUBSTRATE

Outside Wall Section

- Man-Made Composite Technology
- 125% More Puncture Proof
- Additional Insulator
- Noise Reduction
- Moisture, Mold, & Swell Resistant
- Provides the Best Possible Bond with Fiberglass

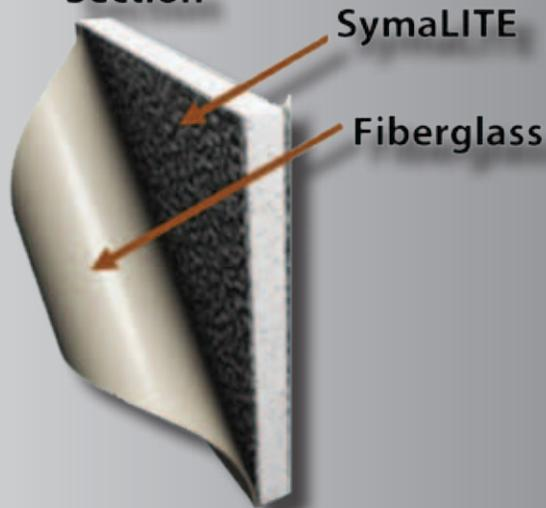

- At 30% Compression the PVC Foam Seal is 100% Waterproof
- Permanent Seal That Won't Deteriorate
- Provides a Complete and Consistant Seal Through-Out

PVC FOAM SEALS

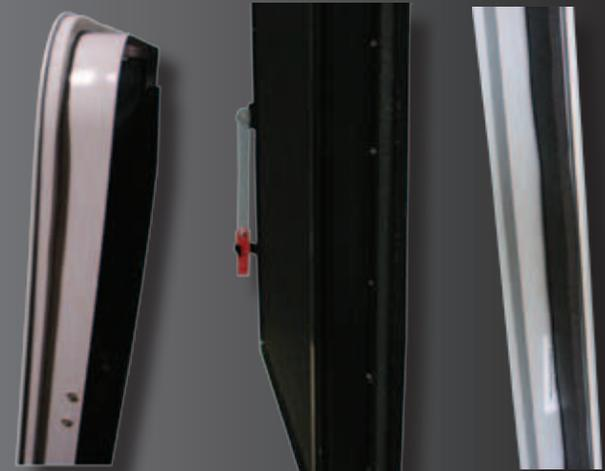

Exterior Features

Full View Vented Entrance Door



50-Amp Service with LED Power Indicator



Automotive Style Window Seal



Compression Latch Baggage Doors



13,500 BTU Ducted A/C



15,000 BTU Ducted A/C



Contoured Cap for Tighter Turning Radius



Carefree Power Awning



4" Extended Drain Spout



LP Slide-out Trays (80 lb. Capacity)

DEXTER AXLE

"Rock Guard"

Outside Kitchen (TT Only)



Four Seasons Protection Package



- Atwood High Performance Furnace
- Heated Storage Area
- Insulated Slide Floors
- Vented Attic
- Double Insulated Baggage Doors
- Digital Thermostat
- Heated Underbelly
- Heated and Enclosed Dump Valves
- R-38 Roof Insulation*
- R-38 Floor Insulation*
- R-9 Sidewalls

ROAMER HEATING DIAGRAM

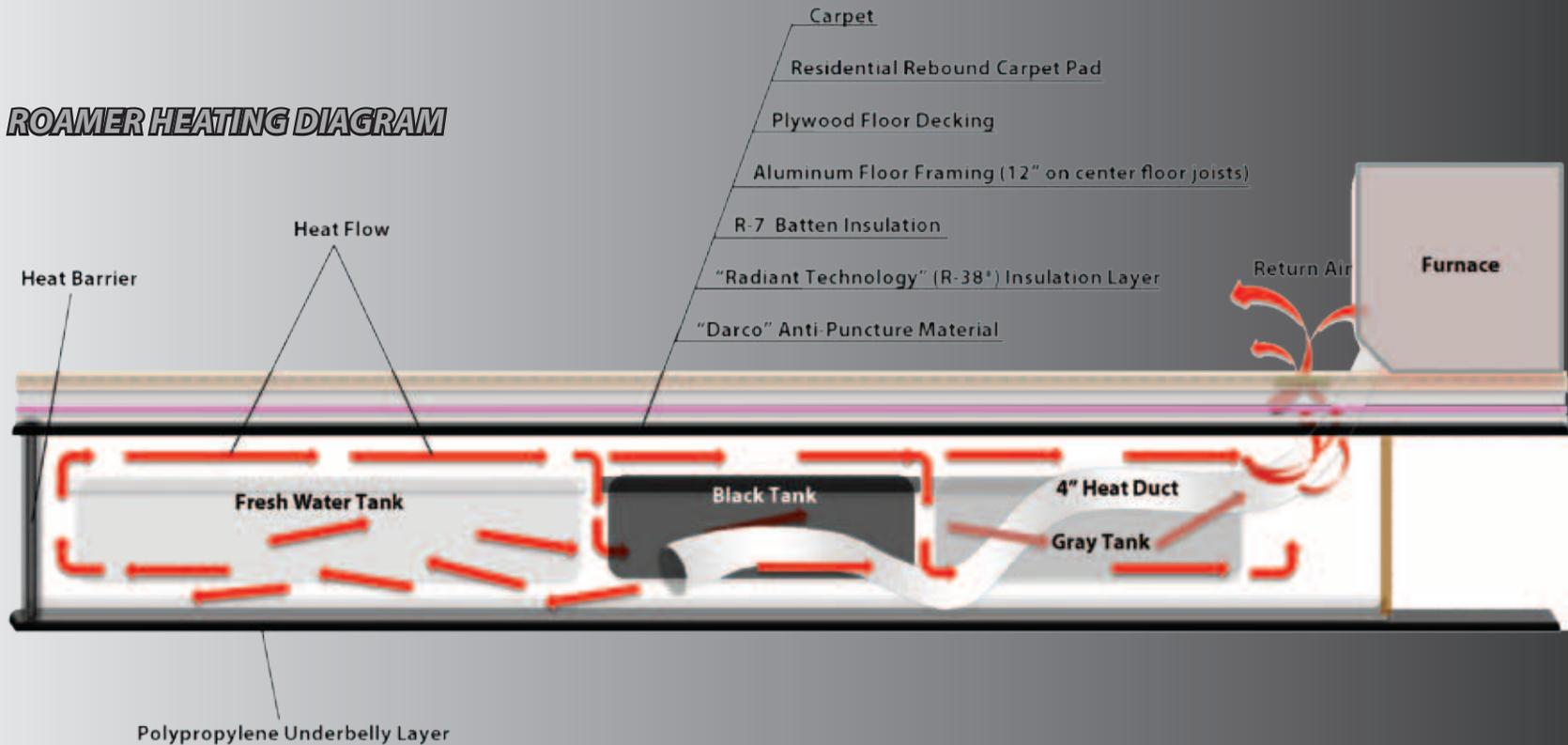

*Calculated

Executive Living Package

Interior:

- Hide-a-Bed Loveseat Sofa
- Large 6 cu ft Refer (TT); 8 cu ft (FW)
- 6 Gal (TT); 10 Gal (FW) Gas/Electric Quick Recovery Water Heater
- 13,500 BTU (TT); 15,000 (FW) Ducted A/C
- Fantastic Fan (FW)
- "Comfort Cloud" Pillowtop Mattress
- Pull-Out Pantry

Exterior:

- Power Awning
- 15" 6-Lug Wheels
- Assist Grab Handle
- Outside Cook Center (TT) *(Most Models)*



Entertainment Package

- 32" LCD TV
- 12v CD/DVD/MP3/AM/FM/iPod/USB Stereo
- Cable Hook-Up
- Satellite Hook-Up
- Outside TV Hookup
- Dual Outside Speakers
- Digital TV Antenna and Booster



Equipped with
**JACK® DIGITAL
HDTV ANTENNA**
with Integrated SureLock
TV Signal Meter!

- No need to crank up or down and is always ready for travel
- Built-in signal meter for fast and accurate antenna pointing
- Full 360° rotation allows for precise antenna pointing with no "dead spot"

A PRODUCT OF
**KING
CONTROLS®**



Decors

Lifelong



Sedonna



Pinto



Interior Standards

- High Output Range w/Igniter and Large 17" Oven
- Hardwood Cabinet Doors
- Pull-Out Waste Basket
- Skylight Above Shower
- Corian Countertops (FW Only)
- Full Extension Drawer Guides
- Glass Shower Door & Surround (FW)

**TWO-YEAR LIMITED
TRANSFERABLE WARRANTY**

Exterior Standards

- Contoured Front Cap for Superior Turning Radius (FW)
- "Dexter" Wide Stance E-Z Lube Axles
- Wired and Framed for 2nd A/C in Bedroom
- 50-Amp Service
- 4-Point Leveling/ Stabilizing System (FW)
- Large Triple 9" Entry Steps (FW)
- Extended Rain Spouts
- Dual LP Slide Trays (FW)
- 2cu Refer (Outside Kitchen) (TT) *(Most Models)*
- Exterior Convenience Center
- "Trail Air" Equa Flex Suspension
- Radial Tires
- Front and Rear Stabilizing Jacks (TT)
- Dual Outdoor Security Lights
- Diamond Plate Bumper Cover (TT)
- LP Quick Connect

PURCHASE LOCALLY

Open Range RV strongly encourages our retail customers to purchase from their local dealership whenever possible due to the following reasons:

1) Our Dealers are as a rule, independently owned and operated businesses. Outside of those customers they personally sold products to, they are not obligated to perform warranty service on Open Range RV products that were purchased elsewhere. There may be an occasion that the customer will be required to return to the point of purchase to satisfy warranty requirements.

2) Although many dealerships will eventually service products not purchased at their dealership, they will usually take care of their customers and other Open Range RV customers who are traveling away from their local dealer as a priority.

3) Local purchases allow a customer to establish a relationship with a dealer close to home. This relationship provides the customer with a convenient location for service and support from a "local" professional.

4) The opportunity for a thorough PDI (Pre Delivery Inspection) and product orientation is an additional benefit of buying from a local dealer. The opportunity for refresher courses or the ability to get questions answered more promptly is another additional benefit of buying from a local dealer.

5) For our Canadian customers, there are also requirements which must be met to bring an RV purchased out of the country to their home. Although not impossible, these requirements may involve such things as additional inspections, certifications, taxes and fees. The local Canadian Dealer is a professional at meeting these requirements.

6) Open Range's goal is for all RV Owners to fully enjoy their RV experience. In light of this goal, and considering the advantages of buying locally, we encourage you to be thorough when determining what product to purchase and which dealer to purchase it from as both are key to your ultimate satisfaction.

Your Open Range Dealer:



Open Range RV Company 3195 N. St. Rd. 5 Shipshewana, IN 46565

Phone: (260) 768-7771 - www.OpenRangeRV.com

Due to continual research and advances, manufacturer reserves the right to change specifications, design, price, and equipment without notice, and assumes no responsibility for any error in the literature. Some items shown are not included as standard or optional equipment

©2011 Open Range RV Company, Shipshewana, Indiana