



JAY FEATHER™

2016

GET UP AND GO
#LETSJAYCO



2
YEAR
WARRANTY



#LETSJAYCO

When you travel with Jayco, fun is the only thing on the agenda. That's because we go the extra mile so you can live in the moment. From comfortable, amenity-packed floorplans to weather-shielding insulation and superior frame construction, you'll have everything you need to adventure every day and make yourself at home every night. Let's get away. Let's make it count. Let's Jayco—and make memories that last a lifetime.

GENERATIONS OF FAMILY FUN



JAY FEATHER

LIGHTEN UP AND LIVE IT UP

Have your s'mores and eat them too. Jay Feather ultra-lite models combine the amenities of a hardwall travel trailer with the get-up-and-go flexibility of tent camping.

THE JAY FEATHER 7: SUPER TOWABLE, EXTRA FUN

Jay Feather 7 models are towable by most minivans, crossovers and SUVs.*



MINIVANS**

MAKE	MODEL	ENGINE
Honda	Odyssey	3.5L V-6
Toyota	Sienna***	3.5L V-6
Nissan	Quest	3.5L V-6
Kia	Sedona	3.5L V-6
Dodge	Grand Caravan***	3.6L V-6
Chrysler	Town & Country***	3.6L V-6



CROSSOVERS

MAKE	MODEL	ENGINE
Ford	Flex***	3.5L V-6
Chevrolet	Traverse FWD/AWD***	3.6L V-6
GMC	Acadia FWD/AWD***	3.6L V-6
Toyota	4Runner	4.0L V-6

* Consult with your authorized automobile manufacturer or vehicle owner's manual; some models require a tow package
 ** Tow rating matches the GVWR of the 16XRB and 18FDB models only
 *** Towing package required



Jay Feather 7: Page 4

The 2016 Jay Feather 7 lineup features nine models, each 7 feet wide.



Jay Feather: Page 6

The 2016 Jay Feather lineup features 12 models, each 8 feet wide.

SHARE YOUR PHOTOS AND STORIES ON SOCIAL MEDIA WITH [#LETSJAYCO](https://twitter.com/letsjayco).



Jayco
Generations of family fun.



16XRB INTERIOR



16XRB BATHROOM

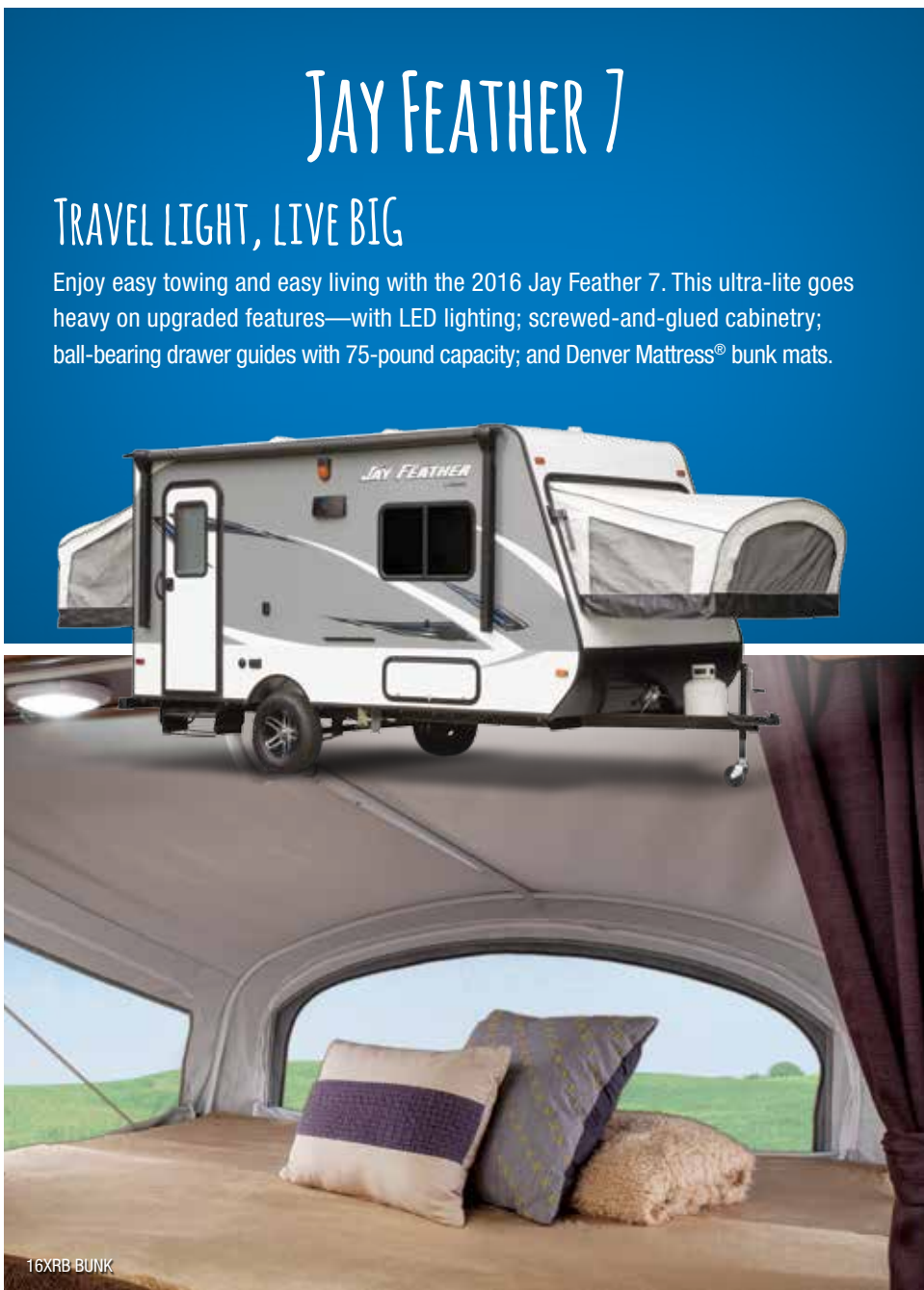

JAY FEATHER 7

TRAVEL LIGHT, LIVE BIG

Enjoy easy towing and easy living with the 2016 Jay Feather 7. This ultra-lite goes heavy on upgraded features—with LED lighting; screwed-and-glued cabinetry; ball-bearing drawer guides with 75-pound capacity; and Denver Mattress® bunk mats.

16XRB BUNK



X254 KING BED



X254 BATHROOM

JAY FEATHER

MAKE ROOM FOR FUN

Don't trade space for easy towing. From full-featured kitchens and family-friendly dinettes to multiple tent ends and a select model king bed slideout, Jay Feather floorplans have options you'll love—at a weight your vehicle can handle.*

*Consult with your authorized automobile manufacturer or vehicle owner's manual; some models require a tow package.



26BHSW BLACK TANK FLUSH



X254 BUNK HOUSE AS STORAGE



X254 BUNK HOUSE



26BHSW KITCHEN



X254 KITCHEN



26BHSW OUTSIDE COOK CENTER



26BHSW AWNING WITH LED

FLOORPLANS

JAY FEATHER 7 FLOORPLANS

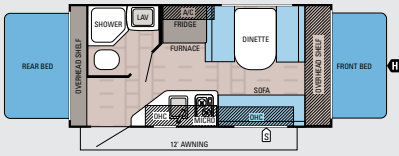

JAY FEATHER 7 | 16XR B

Ext. Length: **18' 10"** Ext. Height: **118"**
Unloaded Wt. (lbs.): **2,845** Sleeps: **6-7**

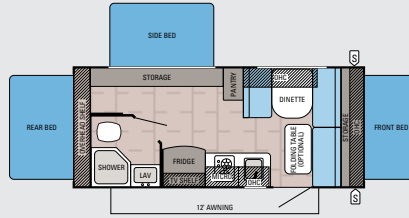

JAY FEATHER 7 | 17XF D

Ext. Length: **20' 8"** Ext. Height: **121"**
Unloaded Wt. (lbs.): **3,310** Sleeps: **7-8**

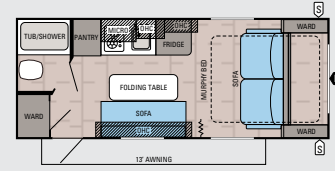

JAY FEATHER 7 | 18RB M

Ext. Length: **22' 1"** Ext. Height: **118"**
Unloaded Wt. (lbs.): **3,015** Sleeps: **2-3**

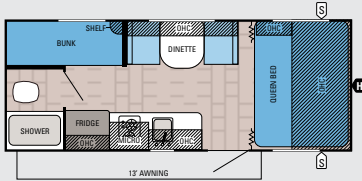

JAY FEATHER 7 | 19B H

Ext. Length: **22' 2"** Ext. Height: **118"**
Unloaded Wt. (lbs.): **3,035** Sleeps: **5**

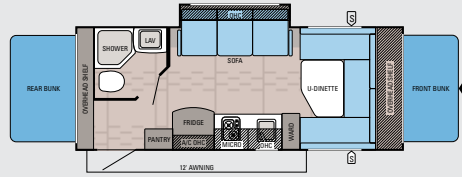

JAY FEATHER 7 | 19XU D

Ext. Length: **22' 4"** Ext. Height: **120"**
Unloaded Wt. (lbs.): **3,530** Sleeps: **7-8**

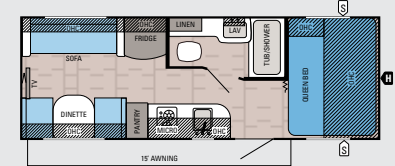

JAY FEATHER 7 | 20R L

Ext. Length: **TBD** Ext. Height: **TBD**
Unloaded Wt. (lbs.): **TBD** Sleeps: **4-5**

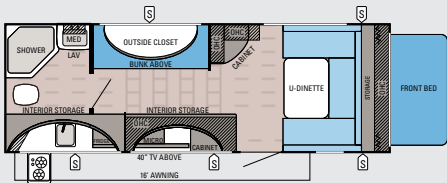

JAY FEATHER 7 | 20XT G

Ext. Length: **24' 5"** Ext. Height: **120"**
Unloaded Wt. (lbs.): **3,840** Sleeps: **4-5**

FOLDING TABLE
STORES IN PASS
THROUGH STORAGE

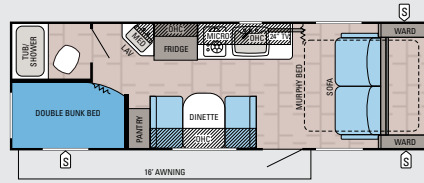

JAY FEATHER 7 | 22B H M

Ext. Length: **26' 5"** Ext. Height: **121"**
Unloaded Wt. (lbs.): **3,945** Sleeps: **6-7**

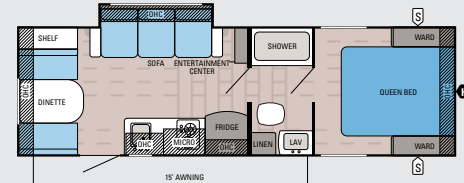

JAY FEATHER 7 | 23R D

Ext. Length: **TBD** Ext. Height: **TBD**
Unloaded Wt. (lbs.): **TBD** Sleeps: **4-6**

JAY FEATHER FLOORPLANS

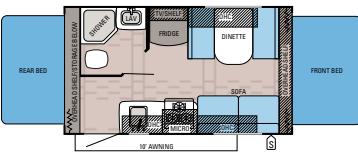

JAY FEATHER | X17 Z

Ext. Length: **18' 7"** Ext. Height: **121"**
Unloaded Wt. (lbs.): **3,085** Sleeps: **6-7**

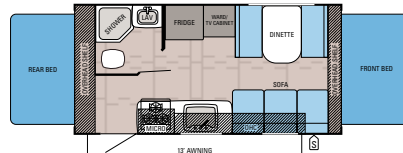

JAY FEATHER | X19 H

Ext. Length: **20' 8"** Ext. Height: **123"**
Unloaded Wt. (lbs.): **3,665** Sleeps: **6-7**

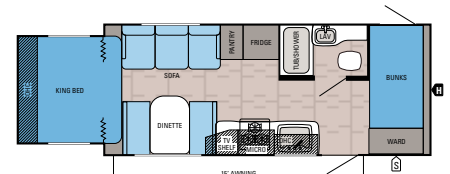

JAY FEATHER | X21 3

Ext. Length: **24'** Ext. Height: **123"**
Unloaded Wt. (lbs.): **4,330** Sleeps: **6-7**

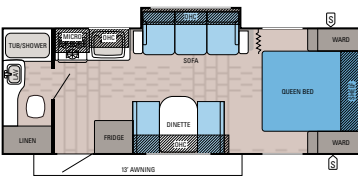

JAY FEATHER | 22FQ SW

Ext. Length: **26' 4"** Ext. Height: **123"**
Unloaded Wt. (lbs.): **4,220** Sleeps: **4-5**

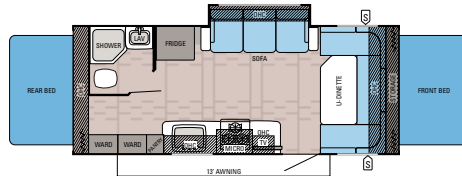

JAY FEATHER | X23 B

Ext. Length: **24' 5"** Ext. Height: **123"**
Unloaded Wt. (lbs.): **4,225** Sleeps: **7-8**

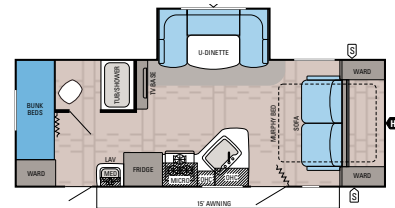

JAY FEATHER | 23B H M

Ext. Length: **26' 4"** Ext. Height: **129"**
Unloaded Wt. (lbs.): **4,825** Sleeps: **4-6**

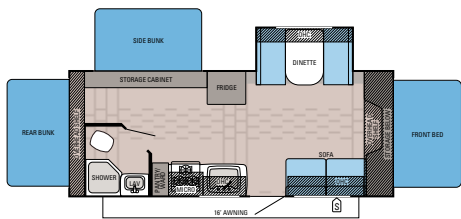

JAY FEATHER | X23F
 Ext. Length: **24' 10"** Ext. Height: **123"**
 Unloaded Wt. (lbs.): **4,400** Sleeps: **8-10**

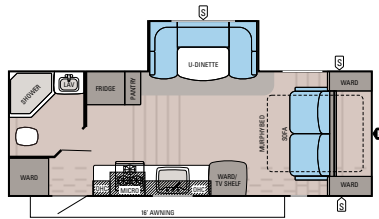

JAY FEATHER | 23RBM
 Ext. Length: **26' 4"** Ext. Height: **129"**
 Unloaded Wt. (lbs.): **4,710** Sleeps: **2-4**

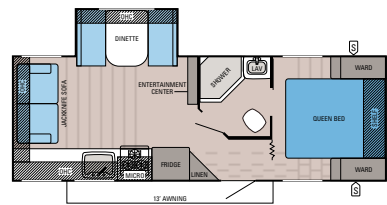

JAY FEATHER | 23RLSW
 Ext. Length: **27' 3"** Ext. Height: **128"**
 Unloaded Wt. (lbs.): **4,605** Sleeps: **4-6**

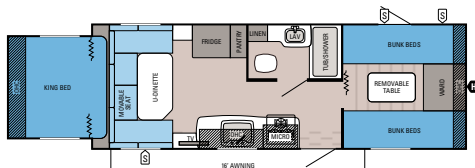

JAY FEATHER | X254
 Ext. Length: **27' 4"** Ext. Height: **122"**
 Unloaded Wt. (lbs.): **4,705** Sleeps: **8**

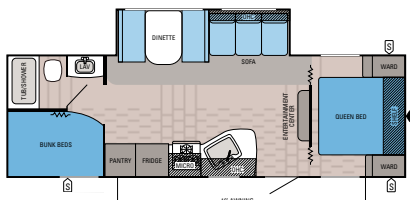

JAY FEATHER | 25BH
 Ext. Length: **30' 4"** Ext. Height: **127"**
 Unloaded Wt. (lbs.): **5,300** Sleeps: **8-10**

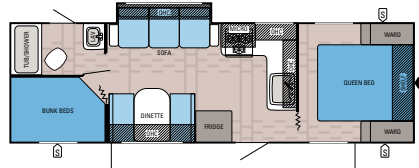

JAY FEATHER | 26BHSW
 Ext. Length: **30' 4"** Ext. Height: **123"**
 Unloaded Wt. (lbs.): **4,815** Sleeps: **8-9**



JAY FEATHER 7 SPECIFICATIONS

MODELS	DIMENSIONS				WEIGHT (LBS.)				TANKS (GALS.)		
	FLOORPLAN	EXTERIOR TRAVEL LENGTH	EXTERIOR WIDTH	EXTERIOR HEIGHT (WITH A/C)	INTERIOR HEIGHT	UNLOADED VEHICLE WEIGHT	DRY HITCH WEIGHT	GROSS VEHICLE WEIGHT RATING	CARGO CARRYING CAPACITY	FRESH WATER CAPACITY (INCLUDES WATER HEATER)	GRAY WASTE WATER CAPACITY
16XRB	18' 10"	85"	118"	78"	2,845	285	3,500	655	31.6	25.4	25.4
17XFD	20' 8"	85"	121"	78"	3,310	320	4,250	940	31.6	25.4	25.4
18RBM	22' 1"	85"	118"	78"	3,015	335	3,975	960	31.6	25.4	25.4
19BH	22' 2"	85"	118"	78"	3,035	285	3,975	940	31.6	25.4	25.4
19XUD	22' 4"	85"	120"	78"	3,530	265	4,250	720	31.6	25.4	25.4
20RL	TBD	85"	TBD	78"	TBD	TBD	TBD	TBD	TBD	TBD	TBD
20XTG	24' 5"	85"	120"	78"	3,840	375	4,950	1,110	25.6	25.4	25.4
22BHM	26' 5"	85"	121"	78"	3,945	405	5,500	1,555	25.6	25.4	25.4
23RD	TBD	85"	TBD	78"	TBD	TBD	TBD	TBD	TBD	TBD	TBD

JAY FEATHER SPECIFICATIONS

MODELS	DIMENSIONS				WEIGHT (LBS.)				TANKS (GALS.)		
	FLOORPLAN	EXTERIOR TRAVEL LENGTH	EXTERIOR WIDTH	EXTERIOR HEIGHT (WITH A/C)	INTERIOR HEIGHT	UNLOADED VEHICLE WEIGHT	DRY HITCH WEIGHT	GROSS VEHICLE WEIGHT RATING	CARGO CARRYING CAPACITY	FRESH WATER CAPACITY (INCLUDES WATER HEATER)	GRAY WASTE WATER CAPACITY
X17Z	18' 7"	96"	121"	78"	3,085	400	3,500	415	28.5	30.5	22.5
X19H	20' 8"	96"	123"	78"	3,665	400	4,950	1,285	48	30.5	22.5
X213	24' 0"	96"	123"	78"	4,330	460	5,500	1,170	48	30.5	22.5
22FQSW	26' 4"	96"	123"	78"	4,220	410	5,500	1,435	48	30.5	22.5
X23B	24' 5"	96"	123"	78"	4,225	440	4,950	725	48	30.5	22.5
23BHM	26' 4"	96"	129"	78"	4,825	555	6,250	1,425	48	30.5	30.5
X23F	24' 10"	96"	123"	78"	4,400	525	5,995	1,595	48	30.5	22.5
23RBM	26' 4"	96"	129"	78"	4,710	460	5,995	1,285	48	30.5	30.5
23RLSW	27' 3"	96"	128"	78"	4,605	490	5,995	1,280	48	22.5	22.5
X254	27' 4"	96"	122"	78"	4,705	625	5,995	1,290	48	30.5	30.5
25BH	30' 4"	96"	127"	78"	5,300	655	6,750	1,450	48	30.5	22.5
26BHSW	30' 4"	96"	123"	78"	4,815	580	6,250	1,435	48	45.0	22.5

Unloaded Vehicle Weight (UVW): Sometimes referred to as "Dry Weight," UVW means the typical weight of this trailer as built at the factory. The UVW, as used in product literature and other promotional materials, does not include cargo, fresh water, propane, options or dealer-installed accessories.

Gross Vehicle Weight Rating (GVWR): GVWR means the maximum permissible weight of the trailer, including the UVW plus passengers, personal items, all cargo, fluids, options, and dealer-installed accessories. The GVWR is equal to or greater than the sum of the UVW and the CCC.

Cargo Carrying Capacity (CCC): CCC means the maximum weight of all passengers, personal items, food, fresh water, propane, tools, other cargo and dealer-installed accessories that can be carried by the trailer. CCC is equal to or less than GVWR minus UVW. The addition of options will decrease the CCC.

Hitch Weight (HW): The hitch weight, as used in product literature and other promotional materials, does not include cargo, fresh water, propane gas, options or dealer-installed accessories. The addition of these types of items will either add to or subtract from the stated hitch weight.

It is important for your safety and enjoyment that your tow vehicle be adequately sized and equipped to tow and handle the GVWR of the RV you select. Review weights and rating of your tow vehicle and consult a competent advisor for questions or advice. Whether you are new to RVing or a veteran, get a feel for the performance of your tow vehicle before heading out on the roadways. When you tow an RV, you must drive differently than when you drive a single vehicle. Practice hooking up, driving, backing up and braking in a safe environment or seek out professional instruction. Jayco affixes a weight label to each RV which lists weight information for that vehicle. See specifications charts above.

WE START WITH ONE OF THE INDUSTRY'S **strongest** foundations

Many competitors modify or weld stock frames, which can weaken the integrity of your foundation. Jayco's custom-manufactured frames offer higher strength and durability.

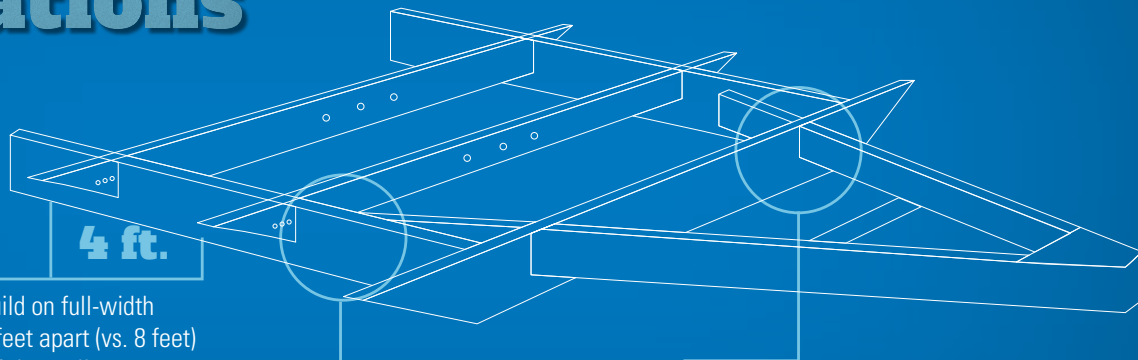

Full-width outriggers: We build on full-width outriggers that are spaced 4-6 feet apart (vs. 8 feet) to better support the weight of the wall.

Norco® NextGen frame: Jay Feather features the industry's strongest strength-to-weight ratio thanks to a Norco NextGen frame made of high-strength, low-alloy sheet steel, huck bolts and an interlocking design (n/a on Jay Feather 7).

Integrated A-frame: The A-frame runs through the main frame, preventing the hitch from buckling—a common issue in competing tack-welded designs.

Learn more at StrongFoundation.Jayco.com

LET'S JAYCO—AND LEAVE OUR WORRIES BEHIND.



We know that your family fun rides on our commitment to quality. So we go the extra mile to make products that last—and stand behind them longer than anyone in the business.

JAYCO'S ROOF **VS** OTHER ROOFS



4,500 POUNDS ON A JAYCO ROOF VS. OTHER ROOFS

THE MAGNUM TRUSS™ ROOF SYSTEM **50 percent stronger**

THE JAYCO DIFFERENCE

When you go with Jayco, you get the strongest foundation in the business, unmatched weatherproofing and rock-solid construction.

- 1. Vacuum-bonded walls, floors and roof** for better protection from the elements
- 2. Lightweight materials and aerodynamic profile** for easier towing
- 3. Extra-wide corner seals** on doors and windows to prevent leaks
- 4. Durable, water-repellent vinyl tent**

- 5. Permanent tent-to-bunk attachment system** offers easy setup; supports up to 1,100 pounds
- 6. Hook tent frame** for more headroom in the bunk area
- 7. Magnum Truss Roof System** withstands 4,500 pounds—50 percent more than other roofs
- 8. 3/8-inch roof decking** secured at every seam
- 9. One-piece, sidewall-wrapped DiFlex II** material provides the ultimate in leak protection

Jay Feather 7
Jay Feather

Exterior Equipment		
Aerodynamic, rounded front profile with front diamond plate	•	•
Deluxe graphics package with 2-colored sidewall	•	•
TuffShell™ vacuum-bonded, laminated floor, side, rear and front walls including slide walls	•	•
Vacuum-bonded, laminated bed platforms with reverse-cambered support (all expandables)	•	•
Magnum Truss Roof System with one-piece seamless DiFlex II material	•	•
Norco NextGen frame with integrated A-frame	•	•
Enclosed underbelly (n/a 16XRB, X17Z, 18RBM, 19XUD, 19BH)	•	•
Equa-Flex® suspension (n/a 16XRB, X17Z, 18RBM, 19BH)	•	•
Single axle (16XRB, X17Z, 18RBM, 19BH)	•	•
Double axle (17XFD, 19XUD, X19H, 20RL, 20XTG, X213, 22BHM, 22FQSW, X23B, 23BHM, X23F, 23RBM, 23RD, 23RLSW, 25BH, X254, 26BHSW)	•	•
G20-tinted safety-glass windows	•	•
Marine-grade exterior speakers (2)	•	•
Black steel wheels with chrome center cap	•	•
Radial tires	•	•
Aluminum rims (2 or 4)	•	•
Standard grease axle with solid-face dust cap	•	•
Impact-resistant wheel wells	•	•
Slideouts with double seals, barrier sponges and U-channel drip spout (applicable models)	•	•
30-amp service	•	•
20-pound propane bottle(s) with auto regulator	•	•
Outside grill LP quick-connect port	•	•
Stabilizer jacks with sand pads (2 on 16XRB, X17Z, 18RBM and 19BH; 4 on all other models)	•	•
Power tongue jack	•	•
6-gallon gas/electric DSI Atwood water heater	•	•
6-gallon gas water heater	•	•
Cable and satellite hookups	•	•
Water-repellent, scratch-resistant Jayco DuraTek™ vinyl tent material with zipper windows (expandable models)	•	•
Powder-coated, painted shepherd's-hook tent supports (expandable models)	•	•
Permanently attached tent-to-bed base design (expandable models)	•	•
Self-supporting, 1,100-pound-capacity lockable tent ends (expandable models)	•	•
8,000-BTU side-mounted A/C	•	•
13,500-BTU roof-mounted A/C	•	•
15,000-BTU roof-mounted A/C	•	•
Spare tire and cover	•	•
Power awning with LED lights	•	•
Black tank flush	•	•

Jay Feather 7
Jay Feather

Outside shower	•	•
Exterior TV bracket with 110V electric and cable outlets	•	•
Outside cook kitchen (22BHM, 25BH, 26BHSW)	•	•
Exterior grill	•	•
Roof ladder (not available on expandable or rear bed slide models)	•	•
Electronic sway control	•	•

Interior Equipment		
Screwed-and-glued cabinetry	•	•
Bead board decorative inserts (select overhead cabinets)	•	•
Ball-bearing drawer glides with 75-pound capacity	•	•
Crown molding and wood batten strips on ceiling	•	•
LED lighting throughout	•	•
AM/FM/CD home theater-style DVD player and Bluetooth®	•	•
AM/FM stereo with MP3/iPod® input	•	•
4-, 5- or 6-cubic-foot refrigerator (model specific)	•	•
2- or 3-burner cooktop (oven included on 3-burner models)	•	•
Microwave	•	•
Sink cover (Jay Feather 7: 20XTG, 22BHM; Jay Feather: n/a X17Z)	•	•
Plywood dinette, bunk and bed bases	•	•
4-inch high-density dinette cushions with vinyl backing	•	•
Wood grain accent paneling on select interior walls	•	•
Jayco-exclusive pillow-top Denver Mattress with bedspread (excluding bed slides, expandable tent beds and bunks)	•	•
Heated bed mats (Jay Feather 7: 1 for 20XTG; 2 for 16XRB and 19XUD; 3 for 17XFD; Jay Feather: 2 for X17Z, X19H and X23B; 3 for X23F)	•	•
Bedroom hanging wardrobes with adjustable shelves (select models)	•	•
Jayco-exclusive Denver Mattress bunk mats	•	•
110V outlet and corner shelf in fixed bunks	•	•
Plastic foot-flush toilet in all models	•	•
Bath skylight and roof vent	•	•
Solid shower enclosure (20XTG, 23RBM, 23RLSW)	•	•
Tub/shower surround	•	•
DiamondFlor® vinyl flooring with cold-crack resistance	•	•
24-inch LED TV (Jay Feather 7: n/a 20RL and 20XTG; Jay Feather: X17Z, X213, X23B and X254)	•	•
32-inch LED TV (Jay Feather 7: 20RL, standard in 20XTG; Jay Feather: n/a X17Z, X213, X23B and X254)	•	•

Optional
Customer Value Package

JAY FEATHER INTERIOR DÉCORS

BRICK

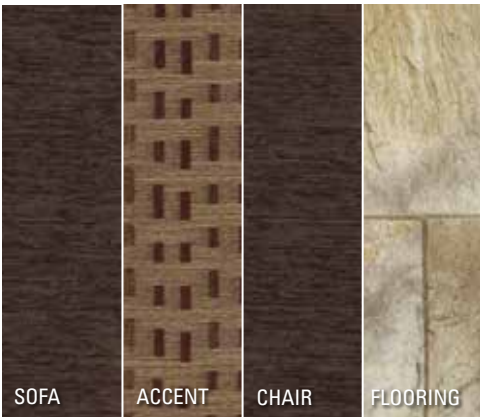

MEADOW



GRANOLA



EXPANDABLE TENTS DELIVER SPACE TO SPARE

Enjoy an easy four-step setup:

1. Unlatch the bed platform.
2. Guide the bed platform down (left).
3. Insert the bed bow brace (right).
4. Make the bed and enjoy!



Generations of family fun.

Meet your Jayco Dealer

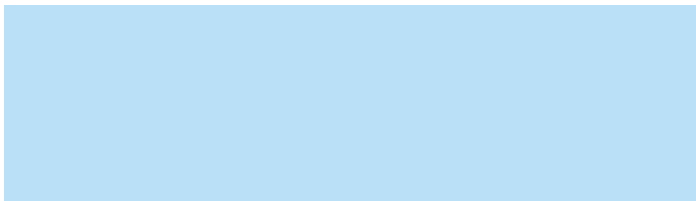

We work hard—so you can play hard. From finding the perfect Jayco for your family to providing flexible financing options and full-service support, we're here to help.

2
YEAR
WARRANTY

FREE
ROADSIDE
ASSISTANCE

Travel with confidence, with our industry-leading, bumper-to-hitch limited warranty and a year's access to Coach-Net™—the country's largest RV emergency road service.

For a copy of our 2-year limited warranty with full terms and conditions, please contact your local Jayco dealer.

eco advantage™

Jayco's long-term commitment to generations of family fun
After four years of increased efforts to eliminate waste, conserve energy and increase recycling, we've come a long way in building RVs that are not only better for your family—but also better for the planet.
Learn more at Jayco.com/EcoAdvantage

Follow Jayco



Jayco, Inc., P.O. Box 460, Middlebury, IN 46540, www.jayco.com © **RVIA** See dealer for further information and prices. All information in this brochure is the latest available at the time of publication approval. Jayco reserves the right to make changes and to discontinue models without notice or obligation. Photos in this brochure may show optional equipment and props for photography purposes. RVs built for sale in Canada may differ to conform to Canadian codes. ©2015 Jayco, Inc. 0116-20K Printed in U.S.A.