



REDWOOD

LUXURY VEHICLES





3401RL Living Area with Savannah Cabinets

From the inception of Redwood, luxury has been a priority. We pride ourselves in offering industry leading features and technology that bring luxury to the forefront. Redwood holds the distinction of being the only RV company started from the ground up by THOR Industries. The product of highly-experienced minds in the RV industry, Redwood has quickly become a flagship for luxury fifth wheels.

We at Redwood believe that greatness is in the details. From the F.I.T. Chassis designed specifically to encompass the foundation of luxury, to the iN-Command smart automation system that gives users complete control from the palm of their hand, Redwood is bringing these details to you. Redwood has and will continue to rely on owners and fellow RVers to help shape and define Redwood from generation to generation. Many of the exclusive features Redwood has offered from the beginning were formed by direct input from full-timers and can be found nowhere else. Our continuous commitment to research, development, and customer feedback is what defines our past, present, and future.

Thank you for considering *The Foundation of Luxury*.



3401RL Bedroom with Savannah Cabinets



3901WB Bathroom with Madison Cabinets



Kitchen Pantry with Madison Cabinets



3901WB Living Area with Madison Cabinets



Autumn Fire

Twilight



Prairie Vista



Partial Paint

A CUSTOM FIT FOR YOU

Falcon Integrated Technology (FIT) ensures quality down to the smallest of details. All components of the FIT chassis system are sourced from industry leading manufacturers, producing one of the industry's most sought-after foundations.

Additionally, having a custom chassis system from industry leaders allows for the use of many industry firsts. This keeps the features and technology of the FIT chassis at the forefront of the best the RV industry has to offer.

At the Root of Every



WELDED HITCH RECEIVER

FIT's integrated hitch receiver can haul 3,000 pounds of additional cargo (300 lb. tongue capacity).

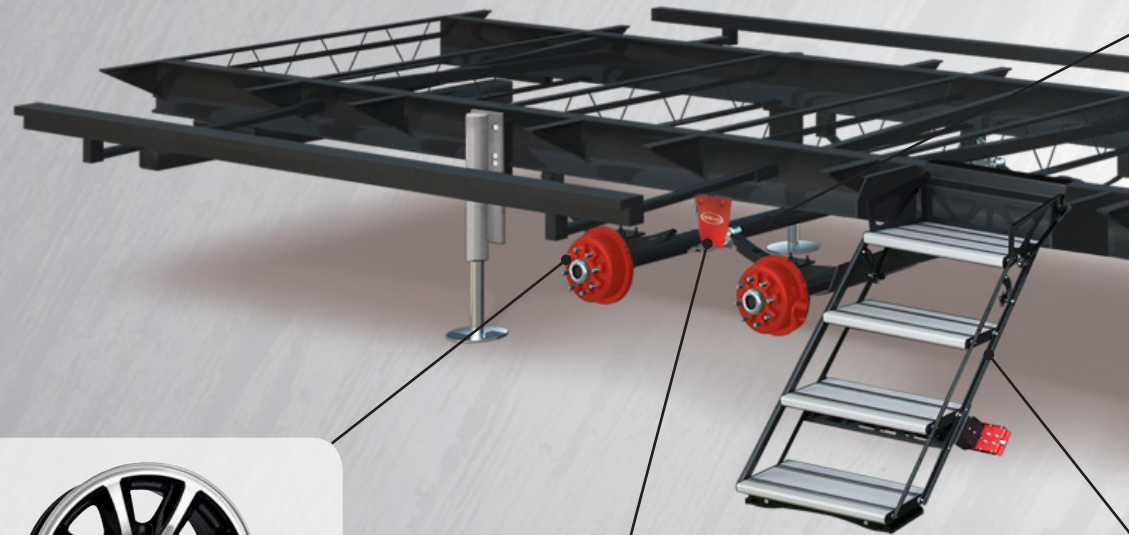

17.5 H RATED TIRES WITH ALUMINUM WHEELS

8 Lug Bearcat aluminum wheels with custom Redwood logo caps set inside 17.5 H rated tires.



LRE 4100 SUSPENSION SYSTEM WITH WET BOLT

MORryde has designed the LRE system to complement the steel leaf spring suspension. The rubber shear springs isolate and absorb road shock as well as provide 4" of suspension travel.

*All of these features are standard on your Redwood RV

Redwood is a F.I.T. Foundation

FALCON BRAND AXLES

Falcon 8,000 lb. axles are built to last and offer many advantages over the competition:

- Self-adjusting brakes improve stopping time up to 50% and lower maintenance costs.
- Powder-coated axle tubes protect against corrosion.
- EZ-Lube hubs allow for quick and easy maintenance.



HYDRAULIC SLIDE-OUT SYSTEM

The gold standard for hydraulic slide-out systems, Falcon provides years of worry-free operation and makes us distinct among the competition.



FLEX AIR PIN BOX

The Flex Air® Pin Box unifies time-tested Trailair® Air Ride technology with the Rota-Flex® pivoting head to reduce chucking and vertical tug-of-war between a fifth-wheel RV and tow vehicle, providing a more comfortable ride. Flex Air® utilizes an air bag and rubberized compound to absorb road shock and vibrations, an integrated oil shock absorber to dampen kickback, and a pivoting head to control chucking.

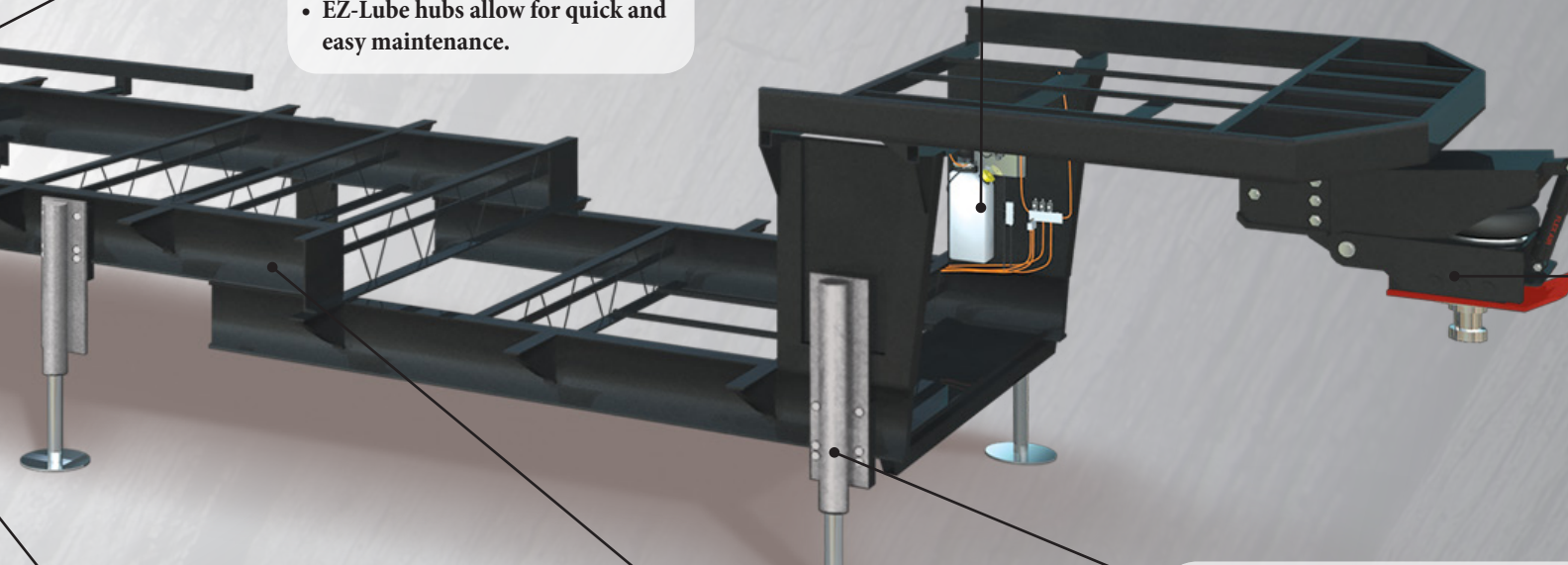

SOLIDSTEP ENTRY STEPS

The SolidStep features an oversized top step for a more secure entry and exit of the coach and is designed to rest on the ground when fully extended, providing a solid, safe RV step system.

THE FALCON FRAME

The Falcon Frame utilizes the very best materials available and represents the best the industry has to offer:

- Powder coated frame for protection
- Heavy-duty 12" I-Beam main rails
- 10" I-Beam drop frame for increased storage capacity.

6-PT. HYDRAULIC AUTO LEVEL

Gone are the days of boards, blocks, and backaches. Every Redwood comes standard with a fully-automatic 6-pt. hydraulic Level Up system. With the touch of a button (and in less than a minute), you can be leveled and ready to relax. When you're ready to go again, a memory function returns the pinbox to the height of your truck's hitch.



CONSTRUCTED FOR

Insulation Components

Subfloor

1. F.I.T. Frame
2. Corrugated Underbelly

Floor

3. Shaw Residential Carpet
4. Residential Carpet Pad
5. Congoleum Vinyl Flooring
6. 5/8" Floor Decking
7. 3" Welded Aluminum Frame
8. Radiant Techno Foil Insulation
9. 2 Layers Batten Insulation
10. Darco Moisture Barrier

Bath Deck

11. 5/8" Floor Decking
12. 3" Welded Aluminum Frame
13. Finished Pass-Thru Ceiling

Sidewalls

14. High-Gloss Fiberglass
15. Double Luan Backer
16. 2" Welded Aluminum Frame
17. Sanded Block Foam Insulation
18. Interior Wall Board

Slide Outs

19. Laminated Outside Wall

- #### 20. Slide End Walls
- Fiberglass Layer
 - Batten Insulation

- #### 21. Slide Roof
- Alpha Ply Roofing
 - Batten Insulation

- #### 22. Slide Floor
- Darco Moisture Barrier

Front/Rear Caps

23. 1 Layers Batten Insulation
24. Molded Fiberglass Cap

Roof

25. Alpha Ply Roofing
26. 3/8" Roof Decking
27. Radiant Techno Foil Insulation
28. Stamped Steel Roof Trusses
29. 1 Layers Batten Insulation
30. Interior Ceiling Board



FULL-TIME LIVING

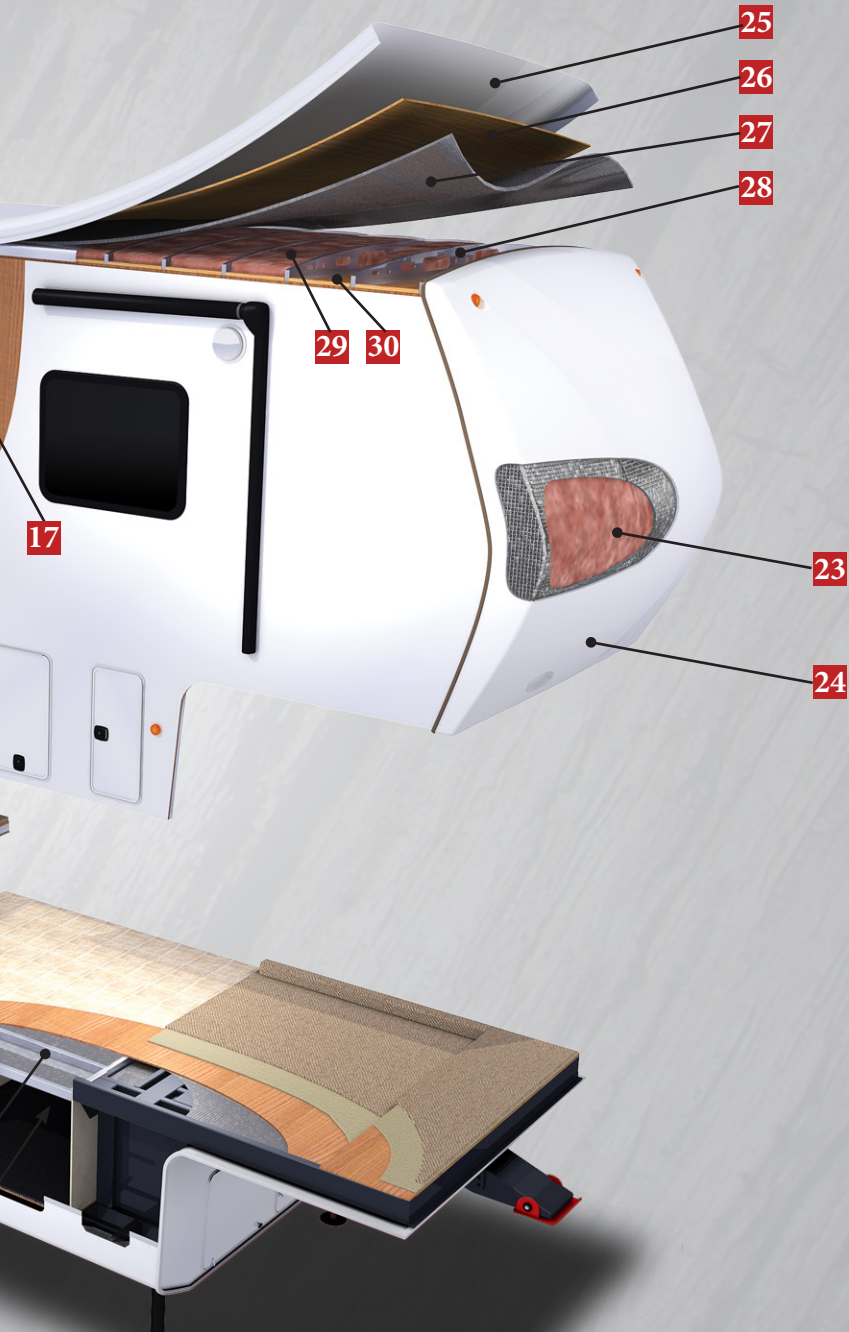

3 LAYERS OF PROTECTION

Sanded Block Foam

Much like a styrofoam coffee cup, sanded block foam is an excellent insulator in both warm and cold conditions. If a 2mm thick coffee cup can keep piping hot coffee from burning your hand, just imagine how well 2 inches of this material keeps your Redwood insulated!



Fiberglass Batten Insulation

Any well-constructed home will employ fiberglass batten insulation due to its outstanding thermal efficiency. Redwood utilizes Ecobatt® insulation - a phenol-free, formaldehyde-free, and acrylic-free form of fiberglass batten insulation.

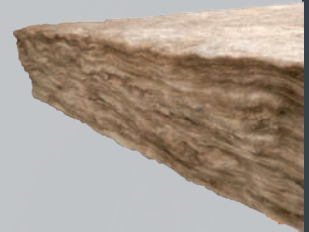

Radiant Technology Foil

Many of Redwood's full-time capabilities are owed to radiant foil. This space-age material acts as a reflective thermal barrier, reflecting an astounding 97% of radiant heat. This serves to reflect heat away from the Redwood in warmer weather, as well as reflect heat back inside in cooler weather.

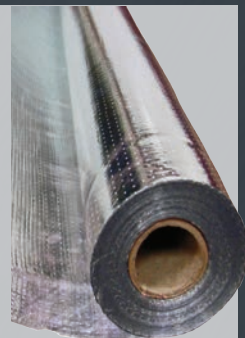

Decor Selections



Divine



Godiva

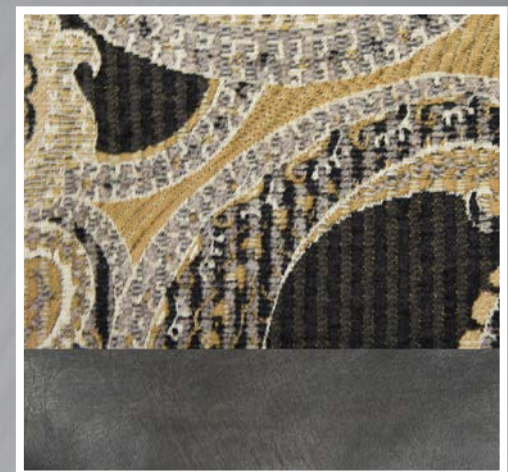

Dove



Savannah



Madison

Redwood customers expect the best. We strive to meet and exceed our customers' expectations in quality, craftsmanship, beauty, and comfort. We stand behind this commitment with our 2-year, full-time approved warranty - designed to give you peace of mind for the road ahead.



STANDARD & OPTIONS

KITCHEN & APPLIANCES

- Solid Maple Hardwood Cabinetry
- Hardwood Stiles Pre-Drilled & Screwed Together
- Residential Sized Storage Drawers
- Pots & Pans Storage
- Full-Extension Ball-Bearing Drawer Guides
- Residential Soft Close Hidden Hinges
- EGS Steel Backed Cabinet Anchors
- Residential Pantry w/ 7 Pullout Drawers & 110v Outlet
- LG Countertops
- LG Sink Covers
- Tile Backsplash
- Oversized 60/40 Stainless Steel Sink
- High Rise Faucet w/Pull Out Sprayer
- Over-Island Lighting
- 22 Ft³ w/ French Door Refrigerator w/ Ice Water in Door
- Residential 3-Burner Gas Cooktop
- 30" Stainless OTR Convection Microwave w/ Exhaust Fan
- Max Air Fan
- Residential Style Oven

BEDROOM

- iCool™ Gel Foam King Bed
- 110v Outlets on Both Sides of Bed
- 39" LED HDTV
- Residential Dresser w/ Drawers
- Walk-In Closet with Shelving (8 ft. wide)
- Night Roller Shades
- 2nd 15k BTU A/C w/Heat Pump

LIVING AREA

- Thomas Pane Collection Furniture Package:
 - Residential Hide-a-Bed Sofa
 - Tru-Sit 5 Function Recliners Theatre Seating
 - Buffet -Style Adjustable Dinette w/ Leaf Extension (VBM)
 - 2 Premium Dinette Chairs
 - 2 Folding Dinette Chairs
- Day/Night Roller Shades
- 55" Samsung Curved HDTV
- Bluetooth Entertainment System w/ Multizone Soundbar & Subwoofer
- Pre-wired for Winegard® Satellite Systems
- Ceiling Fan (VBM)
- Samsung Blu-ray Player
- 5,100 BTU Fireplace - Heats 1,000 Ft²

BATHROOM

- One Piece Fiberglass Shower
- Domed Skylight in Shower
- Porcelain Foot Flush Toilet

- Heat & A/C Duct in Bathroom
- Max Air Fan
- Adjustable Handheld Shower Head
- LG Solid Surface Countertops

GENERAL INTERIOR

- Energy Management System (EMS)
- iN-Command™ Smart Automation System
- LED Recessed Ceiling & Accent Lights
- Solid Hardwood Slide Fascia
- 7' Interior Slide Room Height
- 15,000 BTU Whisper Quiet A/C
- 35,000 BTU Furnace
- Residential Carpet w/ Pad
- Maximum Linoleum Throughout
- Central Vacuum

CONSTRUCTION

Chassis

- Custom FIT Chassis
 - Falcon 12"/10" I-Beam Drop Frame
 - Flex Air Pin Box
 - Falcon Hydraulic Slide Out System w/ Manual Override (Main Slides)
 - Falcon 8,000 lb. Axles
 - MORryde LRE 4100 Suspension System
 - 6-Point Hydraulic Jacks w/Auto Leveling
 - Falcon Aluminum 4-Step Entry
 - Falcon 2" (3,000 lb.) Receiver Hitch
 - 17.5 H Rated Tires (w/ Spare)

Sidewalls

- 2" Laminated Wall
- Sanded Block Foam Insulation
- Double Welded Aluminum Frame
- Double Luan Backer
- High-Gloss Gel Coat Fiberglass

Floor

- 5/8" Floor Decking
- 3" Aluminum Subfloor - 11" on Center (VBM)
- 2 Layers of Batten Fiberglass Insulation
- 1 Layers of Radiant Tech Foil Insulation
- Darco Moisture Barrier
- Corrugated Underbelly
- Fully Enclosed & Heated Underbelly

Roof

- One Piece Alpha-Ply Roof Material
- 5" Galvanized Stamped Steel Trusses
- Double Trusses at each A/C
- 3/8" Roof Decking

- 1 Layers of Batten Fiberglass Insulation
- 1 Layer of Radiant Tech Foil Insulation
- Fully Walkable

General Exterior

- Straight Roof Line (Luxury Profile)
- Front & Rear Insulated Fiberglass Caps
- LED Pin Box Light
- 2nd Power Awning w/ LED (VBM)
- Docking Station w/ All Hookups & Black Tank Flush
- Slam Latch Baggage Doors
- Fully Finished & Heated Pass-Through Storage
- Bauer Keyed-A-Like Lock System
- (2) 45 Gallon Grey Tanks (VBM)
- 45 Gallon Black Tank (VBM)
- Tanks Heated via Forced Heat
- 12 gal. DSI Hot Water Heater
- Enclosed & Heated Water Lines
- Seamless Residential Heat Ducts
- Radius Whole-House A/C Ducting
- Frameless Windows
- Exterior Speakers
- Wireless Backup Camera Prep
- Progressive 90 Amp/12v DC Power Converter
- Power Cord Reel-Electric (VBM)
- 1,000 Watt Inverter w/ Residential Fridge
- 110v Exterior Receptacle
- Aluminum Wheels w/ Redwood Center Caps
- 3-3/8" Self-Adjusting Drum Brakes
- (2) 30 lb. LP Tanks w/Auto Change Over

Options

- Fisher-Paykel Dishwasher
- 3rd 15,000 BTU A/C
- Electric Induction Cooktop
- 5.5 Onan LP Generator
- Holding Tank Heating Pads
- Slide Awning Package
- Disc Brakes
- Full Body Paint
- 18 Ft³ Side-by-Side Norcold Refrigerator w/ Ice Maker
- Wireless Backup Camera w/ Monitor
- Generator Prep

Relax. You're iN-Command[®]



**Display
Commander**



- ✓ **Never lose your controller**
- ✓ **Unlimited Users**
- ✓ **When you have your phone, you're iN-Command**

Control • Systems Monitoring • Safety

FINALLY A SYSTEM YOU CAN TRUST.

iN-Command embraces the next generation of controls for your Redwood RV by acting as the central hub of operations and puts you at the helm using your preferred smart device. But how does this all-encompassing system work? What, exactly, does it monitor and control? Let's take a closer look at iN-Command piece by piece.

The Display Commander is your primary point of contact with iN-Command. All of the switches and monitoring panels that have cluttered up interior walls in the past are integrated into this one sleek, touch screen monitor. What really makes the Display Commander stand out, however, is that it can be controlled remotely with a smart device using the free JENSEN iN-Command mobile app. This app performs all of the same functions as the Display Commander, but from the convenience of your mobile device.



**Download and Install
the Free JENSEN
iN-Command™ App
from Google Play or
Apple App Store for the
ultimate in control.**

*WORKS WITH IPHONE, IPAD,
ANDROID PHONES AND TABLETS.

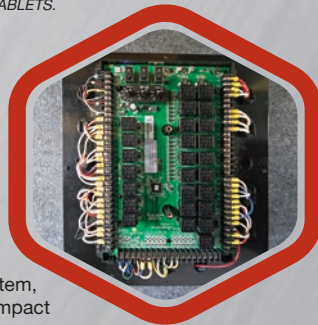

Body Control Module

At the core of iN-Command is the control board, or "brain" of the system, the Body Control Module. The main board, itself, is protected by an impact resistant cover. The inside of this cover features detailed connection labeling, along with the wiring guide.



The Foundation of Luxury



www.redwood-rv.com • 1140 W. Lake St Topeka, IN 46571 • (260) 593 - 3850

DISCLAIMER: Product information is as accurate as possible as of the date of publication of this brochure. All features, floor plans, and specifications in this brochure are subject to change without notice. Please also consult Redwood's web site at www.redwood-rv.com for more current product information and specifications. Tow Vehicle Disclaimer. CAUTION: Owners of Redwood recreational vehicles are solely responsible for the selection and proper use of tow vehicles. All customers should consult with a motor vehicle manufacturer or their dealer concerning the purchase and use of suitable tow vehicles for Redwood products. Redwood disclaims any liability or damages suffered as a result of the selection, operation, use or misuse of a tow vehicle. REDWOOD LIMITED WARRANTY DOES NOT COVER DAMAGE TO THE RECREATIONAL VEHICLE OR THE TOW VEHICLE AS A RESULT OF THE SELECTION, OPERATION, USE OR MISUSE OF THE TOW VEHICLE. REFERENCE REDWOOD RV COMPANY OWNERS MANUAL FOR LIMITED WARRANTY DETAILS. *Length is defined as the distance from the centerline of hitch pin/coupler to rear bumper of trailer.