

# Jay Flight 2018



# Jayco®

Generations of family fun.



JAY FLIGHT SLX SINGLE-AXLE



JAY FLIGHT SLX DOUBLE-AXLE



JAY FLIGHT FIBERGLASS OPTION





## Our Wings Get You There

Family fun happens when you spread your wings. Thanks to Jayco's amenity-packed floorplans, rock-solid construction and two full camping seasons of warranty coverage, you can. Greater peace of mind and added comfort mean better memories and lasting bonds. So go ahead. Hit the road—and let the good times fly.

## Generations of Family Fun



**Jay Flight SLX (single-axle):** Page 4  
16' to 22' in length



**Jay Flight SLX (double-axle):** Page 4  
25' to 36' in length



**Jay Flight:** Page 6  
25' to 40' in length



## DISCOVER AMERICA'S NO. 1 SELLING TRAVEL TRAILER

If it's not done well, it's not worth doing. That was Jayco founder Lloyd Bontrager's philosophy. He thought that his family deserved a better RV—and that yours does, too. One that's sturdy, carefully designed and built to last. Nearly 50 years later, his legacy lives on—in the Jay Flight.

### JAY FLIGHT VS. COMPETITOR TRAVEL TRAILERS

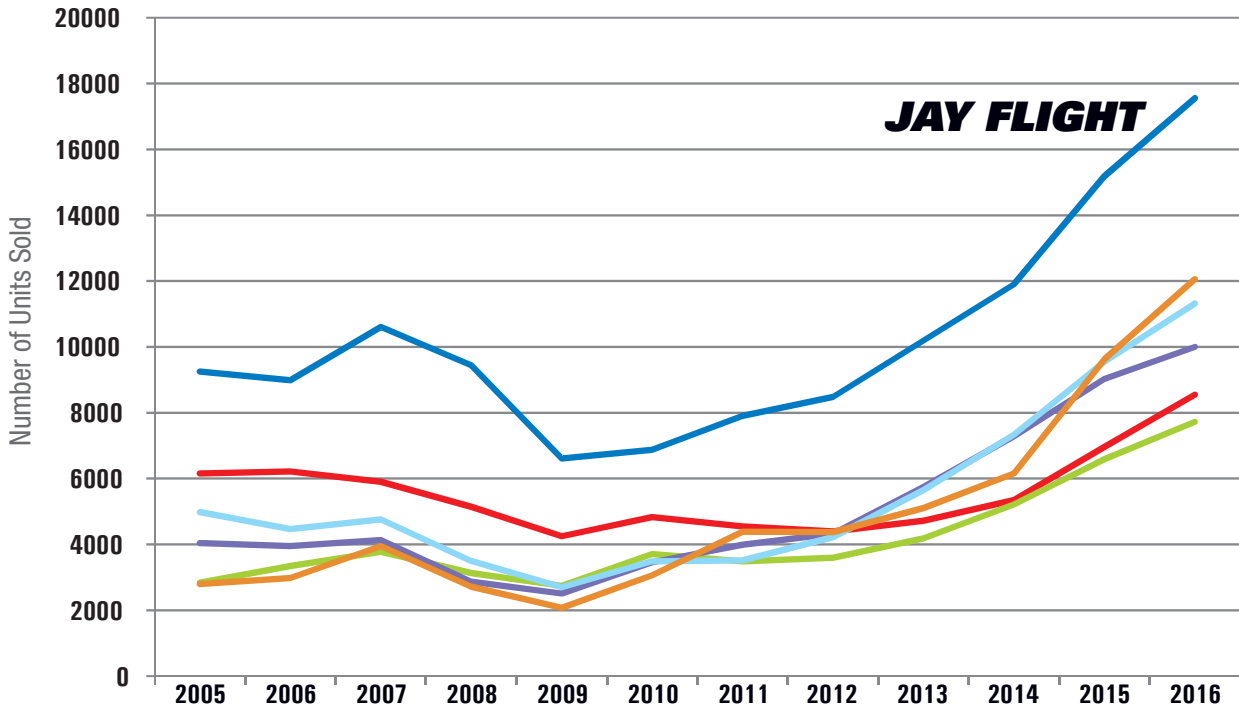

National Stat Surveys — December year-end travel trailer shipments



### WHY WE CAN OFFER THE INDUSTRY'S LONGEST WARRANTY

From concept to completion, we pay the closest attention to the little things that make our RVs stronger, more durable and more reliable than the competition. It's the reason that, with the support from our select partners, we have you covered for 730 days. That's two full camping seasons. So go explore.



SINCE 1996, JAYCO HAS WON 77 DEALER SATISFACTION INDEX GOLD CIRCLE AWARDS



212QB INTERIOR



POWER AWNING WITH LED LIGHT AND EXTERIOR SPEAKERS



PASS-THROUGH STORAGE (MOST MODELS)



SIMMONS® MATTRESS (SELECT MODELS)



SPARE TIRE WITH COVER



212QBW KITCHEN



RADIO



# JAY FLIGHT SLX

175RD INTERIOR



175RD KITCHEN



212QB MASTER BEDROOM



212QB BATHROOM

## MAIN INTERIOR KEY

1. Interior LED lighting
2. Decorative lighting above dinette and on slideout wall
3. 8-cubic-foot refrigerator
4. Shaw® residential carpet
5. Pleated shades with large panoramic window
6. Directional and closeable A/C vents

## ELITE PACKAGE (MANDATORY)

- Black tank flush
- Second fresh water tank (80-gallon total capacity)
- Large main entry door grab handle\*
- 8-cubic-foot refrigerator with stainless front (18-cubic-foot residential refrigerator in 38BHDS and 38FDDS)
- Large 50/50 kitchen sink with pullout faucet
- Upgraded kitchen sink with cover and drying rack\*
- Porcelain foot flush toilet\*
- Stainless microwave oven
- Stainless oven
- Chocolate Maple cabinet doors\*
- AM/FM/CD/DVD player with MP3 input and Bluetooth® and HDMI® connectivity\*
- Solar prep
- Dual USB/12V charging port\*

\*Pictured below



LARGE MAIN ENTRY DOOR GRAB HANDLE



UPGRADED KITCHEN SINK WITH COVER AND DRYING RACK

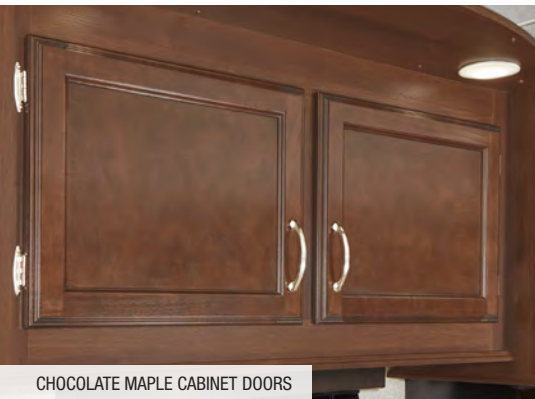

CHOCOLATE MAPLE CABINET DOORS



AM/FM/CD/DVD PLAYER WITH MP3 INPUT AND BLUETOOTH AND HDMI CONNECTIVITY



PORCELAIN FOOT FLUSH TOILET



DUAL USB AND 12V CHARGING PORT



2

## STANDARD FEATURES



QUEEN SIMMONS® MATTRESS



DINETTE STORAGE WITH REMOVABLE TRAYS



# JAY FLIGHT

## POPULAR OPTIONS



ENTERTAINMENT CENTER WITH OPTIONAL LED TV



THERMAL PACKAGE: INSULATED, HEATED (N/A ON 21QB AND 26BH) AND ENCLOSED UNDERBELLY, REFLECTIVE FOIL INSULATION IN MAIN ROOF AND SLIDEOUT FLOORS



OUTSIDE KITCHEN (SELECT MODELS)



FIBERGLASS SIDEWALLS WITH FRAMELESS WINDOWS



HIDE-A-BED WITH LED FLOOR LIGHTING (SELECT MODELS)

## JAY FLIGHT SLX FLOORPLANS 7-FOOT

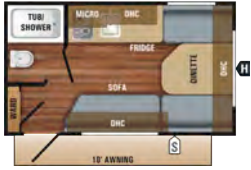

**JAY FLIGHT SLX | 145RB**  
Ext. Lgth: 16' 6" Ext. Ht: 107"  
Unloaded Wt. (lbs): 2,410 Sleeps: 2-3

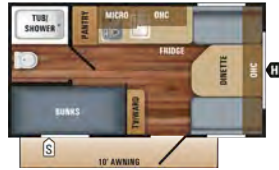

**JAY FLIGHT SLX | 154BH**  
Ext. Lgth: 17' 10" Ext. Ht: 108"  
Unloaded Wt. (lbs): 2,585 Sleeps: 3-4



**JAY FLIGHT SLX | 174BH**  
Ext. Lgth: 21' 6" Ext. Ht: 108"  
Unloaded Wt. (lbs): 2,960 Sleeps: 5-8

OPTION:

OPTION A

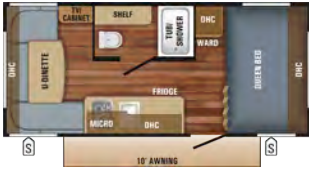

**JAY FLIGHT SLX | 175RD**  
Ext. Lgth: 20' 7" Ext. Ht: 108"  
Unloaded Wt. (lbs): 2,885 Sleeps: 3-4

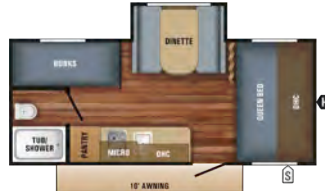

**JAY FLIGHT SLX | 184BS**  
Ext. Lgth: 21' 5" Ext. Ht: 114"  
Unloaded Wt. (lbs): 3,190 Sleeps: 5-8



**JAY FLIGHT SLX | 195RB**  
Ext. Lgth: 21' 8" Ext. Ht: 107"  
Unloaded Wt. (lbs): 2,890 Sleeps: 3-4

## JAY FLIGHT SLX FLOORPLANS 8-FOOT



**JAY FLIGHT SLX | 212QB**  
Ext. Lgth: 25' 6" Ext. Ht: 126"  
Unloaded Wt. (lbs): 4,155 Sleeps: 4-5



**JAY FLIGHT SLX | 224BH**  
Ext. Lgth: 26' 11" Ext. Ht: 125"  
Unloaded Wt. (lbs): 4,435 Sleeps: 7-8



**JAY FLIGHT SLX | 232RB**  
Ext. Lgth: 27' 2" Ext. Ht: 126"  
Unloaded Wt. (lbs): 4,260 Sleeps: 4-6



**JAY FLIGHT SLX | 242BHS**  
Ext. Lgth: 29' 2" Ext. Ht: 133"  
Unloaded Wt. (lbs): 5,405 Sleeps: 7-8

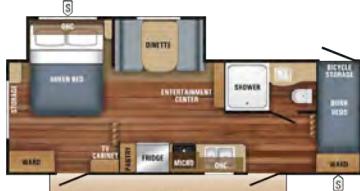

**JAY FLIGHT SLX | 244BHS**  
Ext. Lgth: 28' 8" Ext. Ht: 133"  
Unloaded Wt. (lbs): 5,535 Sleeps: 5-8



**JAY FLIGHT SLX | 245RLS** OPTION A  
Ext. Lgth: 28' 2" Ext. Ht: 132"  
Unloaded Wt. (lbs): 5,220 Sleeps: 4-6



**JAY FLIGHT SLX | 264BH**  
Ext. Lgth: 29' 3" Ext. Ht: 126"  
Unloaded Wt. (lbs): 4,615 Sleeps: 8-10



**JAY FLIGHT SLX | 265RLS** OPTION A  
Ext. Lgth: 30' 11" Ext. Ht: 132"  
Unloaded Wt. (lbs): 5,960 Sleeps: 4-6

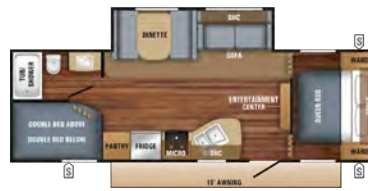

**JAY FLIGHT SLX | 267BHS** OPTION A  
Ext. Lgth: 30' 2" Ext. Ht: 133"  
Unloaded Wt. (lbs): 5,600 Sleeps: 8-10

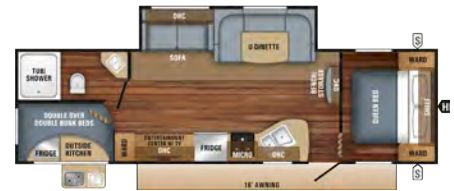

**JAY FLIGHT SLX | 284BHS** OPTION A  
Ext. Lgth: 33' 5" Ext. Ht: 132"  
Unloaded Wt. (lbs): 6,140 Sleeps: 6-8



**JAY FLIGHT SLX | 287BHS** OPTION A  
Ext. Lgth: 33' 5" Ext. Ht: 132"  
Unloaded Wt. (lbs): 6,025 Sleeps: 8-10



**JAY FLIGHT SLX | 294QBS** OPTION A  
Ext. Lgth: 35' 5" Ext. Ht: 133"  
Unloaded Wt. (lbs): 6,480 Sleeps: 8-10

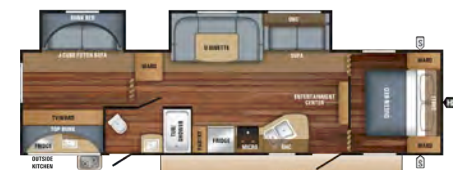

**JAY FLIGHT SLX | 324BDS** OPTION A  
Ext. Lgth: 36' 2" Ext. Ht: 134"  
Unloaded Wt. (lbs): 7,615 Sleeps: 6-10



# JAY FLIGHT SLX SPECS

MODELS	DIMENSIONS				WEIGHT (LBS.)				TANKS (GALS.)		
	FLOORPLAN	EXTERIOR TRAVEL LENGTH	EXTERIOR WIDTH	EXTERIOR HEIGHT (WITH A/C)	INTERIOR HEIGHT	UNLOADED VEHICLE WEIGHT	DRY HITCH WEIGHT	GROSS VEHICLE WEIGHT RATING	CARGO CARRYING CAPACITY	FRESH WATER CAPACITY (INCLUDES WATER HEATER)	GREY WASTE WATER CAPACITY
145RB	16' 6"	85"	107"	73"	2,410	250	2,995	585	10	19.9	19.9
154BH	17' 10"	85"	108"	73"	2,585	315	3,250	665	10	19.9	19.9
174BH	21' 6"	85"	108"	73"	2,960	315	3,750	790	20	19.9	19.9
175RD	20' 7"	85"	108"	73"	2,885	320	3,750	865	20	19.9	19.9
184BS	21' 5"	85"	114"	73"	3,190	325	3,750	560	26	19.9	19.9
195RB	21' 8"	85"	107"	73"	2,890	290	3,750	860	20	19.9	19.9
212QB	25' 6"	96"	126"	81"	4,200	435	5,500	1,300	48	33	39
224BH	26' 11"	96"	125"	81"	4,435	455	5,500	1,065	48	39	39
232RB	27' 2"	96"	126"	81"	4,260	460	5,600	1,340	48	39	39
242BHS	29' 2"	96"	133"	81"	5,405	620	7,000	1,595	44	39	39
244BHS	28' 8"	96"	133"	81"	5,535	645	6,750	1,215	44	39	39
245RLS	28' 2"	96"	132"	81"	5,220	560	7,000	1,780	44	39	39
264BH	29' 3"	96"	126"	81"	4,615	470	6,000	1,385	48	39	39
265RLS	30' 11"	96"	132"	81"	5,960	680	7,000	1,040	44	39	39
267BHS	30' 2"	96"	133"	81"	5,600	665	7,000	1,400	44	39	39
284BHS	33' 5"	96"	132"	81"	6,140	695	7,500	1,360	44	39	39
287BHS	33' 5"	96"	132"	81"	6,025	660	7,500	1,475	44	39	39
294QBS	35' 5"	96"	133"	81"	6,480	780	8,250	1,770	44	47.5	39
324BDS	36' 2"	96"	134"	81"	7,615	940	9,000	1,385	46	41	39

\*Split tanks

## JAY FLIGHT FLOORPLANS

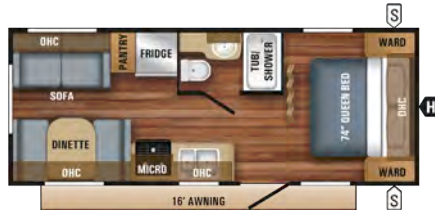

### JAY FLIGHT | 21QB

Ext. Lgth: 25' 6" Ext. Ht: 126" Unloaded Wt. (lbs): 4,425 Sleeps: 4-5

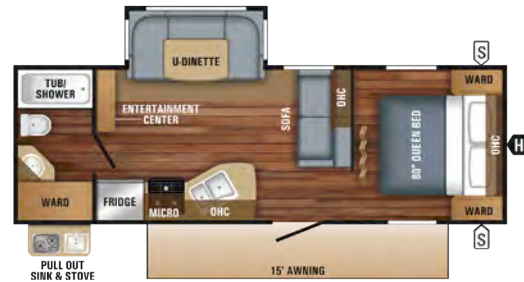

### JAY FLIGHT | 24RBS OPTION A

Ext. Lgth: 28' 8" Ext. Ht: 133" Unloaded Wt. (lbs): 5,505 Sleeps: 4-6



### JAY FLIGHT | 26BH OPTION B

Ext. Lgth: 29' 3" Ext. Ht: 126" Unloaded Wt. (lbs): 4,855 Sleeps: 8-10

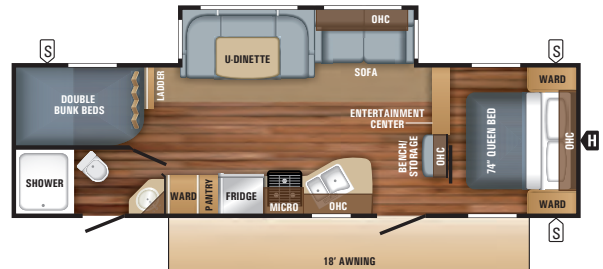

### JAY FLIGHT | 28BHBE OPTION C

Ext. Lgth: 33' 5" Ext. Ht: 134" Unloaded Wt. (lbs): 6,515 Sleeps: 9-10



### JAY FLIGHT | 28BHS OPTION B

Ext. Lgth: 33' 2" Ext. Ht: 134" Unloaded Wt. (lbs): 6,645 Sleeps: 8-10



### JAY FLIGHT | 28RLS OPTIONS: A, C

Ext. Lgth: 32' 5" Ext. Ht: 132" Unloaded Wt. (lbs): 6,390 Sleeps: 3-6

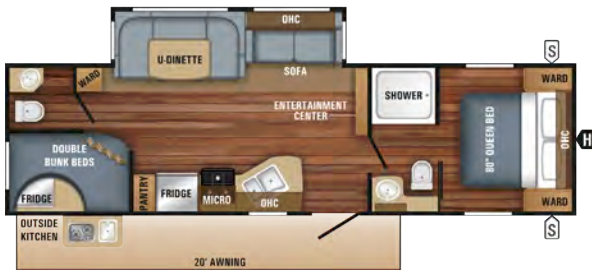

**JAY FLIGHT | 29BHDB | OPTION C**

Ext. Lgth: 34' 2" Ext. Ht: 133" Unloaded Wt. (lbs): 6,800 Sleeps: 8-10

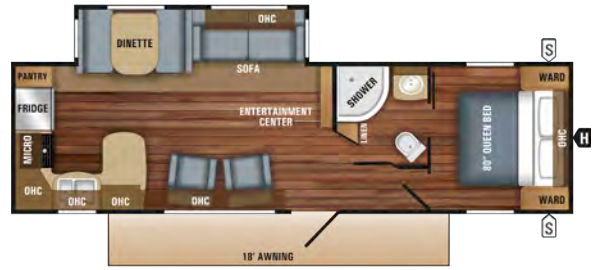

**JAY FLIGHT | 29RKS | OPTIONS: A, C, D**

Ext. Lgth: 33' 9" Ext. Ht: 134" Unloaded Wt. (lbs): 6,770 Sleeps: 3-6

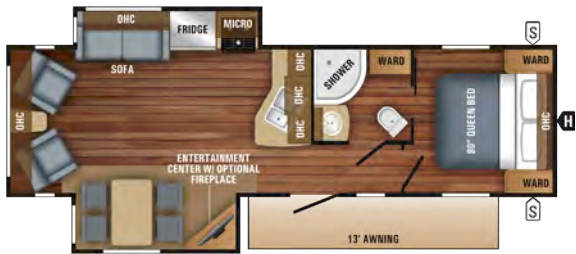

**JAY FLIGHT | 29RLDS | OPTIONS: C, D**

Ext. Lgth: 33' 2" Ext. Ht: 134" Unloaded Wt. (lbs): 6,760 Sleeps: 2-4

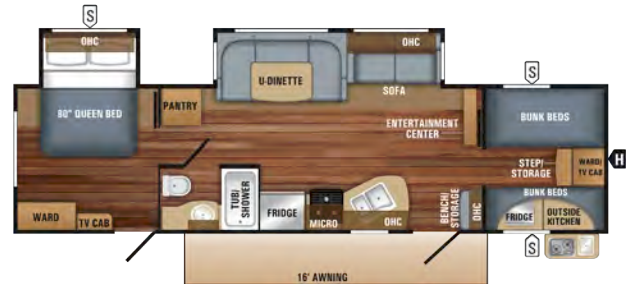

**JAY FLIGHT | 31QBDS | OPTION C**

Ext. Lgth: 35' 10" Ext. Ht: 134" Unloaded Wt. (lbs): 7,625 Sleeps: 8-10

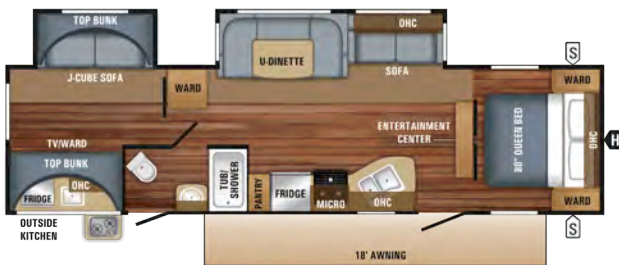

**JAY FLIGHT | 32BHDS | OPTION C**

Ext. Lgth: 36' 2" Ext. Ht: 134" Unloaded Wt. (lbs): 7,935 Sleeps: 8-10

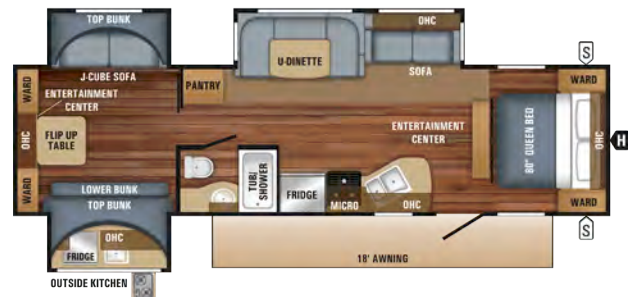

**JAY FLIGHT | 32TSBH | OPTION C**

Ext. Lgth: 36' 2" Ext. Ht: 134" Unloaded Wt. (lbs): 8,515 Sleeps: 9-11

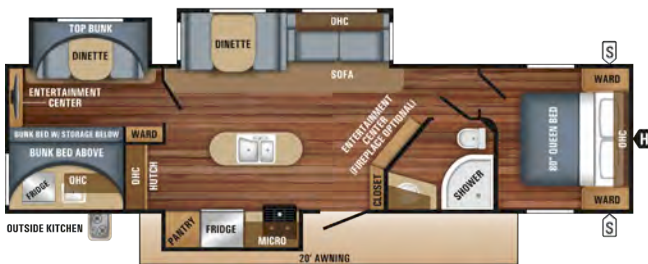

**JAY FLIGHT | 33RBTS | OPTION D**

Ext. Lgth: 37' 8" Ext. Ht: 134" Unloaded Wt. (lbs): 8,600 Sleeps: 7-9



**JAY FLIGHT | 34RSBS | OPTIONS: A, D, E, F**

Ext. Lgth: 37' 6" Ext. Ht: 134" Unloaded Wt. (lbs): 8,765 Sleeps: 3-6

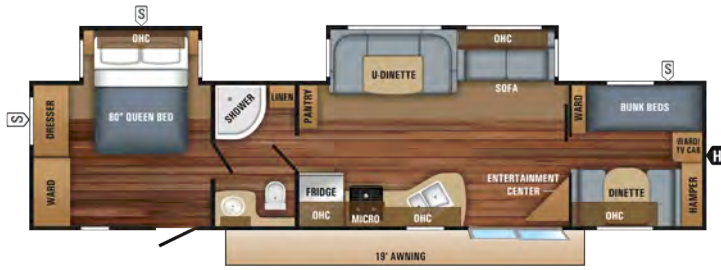

**JAY FLIGHT | 38BHDS** OPTIONS: C, E, G, H, I  
 Ext. Lgth: 40' 4" Ext. Ht: 136" Unloaded Wt. (lbs): 7,960 Sleeps: 8-10

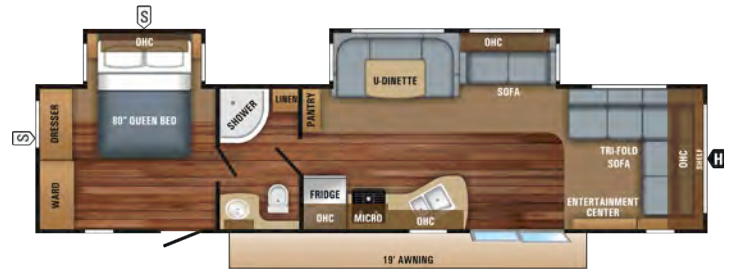

**JAY FLIGHT | 38FDDS** OPTIONS: C, E, G  
 Ext. Lgth: 40' 4" Ext. Ht: 135" Unloaded Wt. (lbs): 8,325 Sleeps: 6-8

**OPTIONS:**

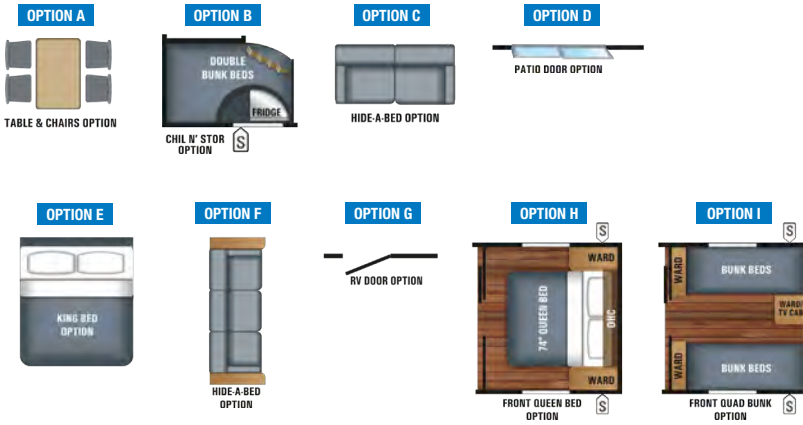

**FLOORPLAN LEGEND:**

- STORAGE
- TRAILER HITCH
- LAV BATHROOM SINK
- MED MEDICINE CABINET
- MICRO MICROWAVE
- OHC OVERHEAD CABINETS
- FRIDGE REFRIGERATOR
- WARD WARDROBE

**JAY FLIGHT SPECS**

MODELS	DIMENSIONS				WEIGHT (LBS.)				TANKS (GALS.)		
	FLOORPLAN	EXTERIOR TRAVEL LENGTH	EXTERIOR WIDTH	EXTERIOR HEIGHT (WITH A/C)	INTERIOR HEIGHT	UNLOADED VEHICLE WEIGHT	DRY HITCH WEIGHT	GROSS VEHICLE WEIGHT RATING	CARGO CARRYING CAPACITY	FRESH WATER CAPACITY (INCLUDES WATER HEATER)	GREY WASTE WATER CAPACITY
21QB	25' 6"	96"	126"	81"	4,425	525	6,500	2,075	84	39	33
24RBS	28' 8"	96"	133"	81"	5,505	625	7,500	1,995	76	39	39
26BH	29' 3"	96"	126"	81"	4,855	520	7,000	2,145	84	39	39
28BHBE	33' 5"	96"	134"	81"	6,515	635	9,250	2,735	76	39	39
28BHS	33' 2"	96"	134"	81"	6,645	800	8,750	2,105	76	39	39
28RLS	32' 5"	96"	132"	81"	6,390	700	8,800	2,410	76	39	39
29BHDB	34' 2"	96"	133"	81"	6,800	780	9,250	2,450	76	78	78
29RKS	33' 9"	96"	134"	81"	6,770	800	9,500	2,730	80	78	39
29RLDS	33' 2"	96"	134"	81"	6,760	810	9,250	2,490	80	39	39
31QBDS	35' 10"	96"	134"	81"	7,625	900	10,250	2,625	80	41	39
32BHDS	36' 2"	96"	134"	81"	7,935	895	9,995	2,060	80	41	39
32TSBH	36' 2"	96"	134"	81"	8,515	745	10,950	2,435	80	41	39
33RBTS	37' 8"	96"	134"	81"	8,600	875	10,950	2,350	80	71.5	39
34RSBS	37' 6"	96"	134"	81"	8,765	1,260	11,250	2,485	80	78	39
38BHDS	40' 4"	96"	136"	81"	7,960	855	10,950	2,990	80	39	39
38FDDS	40' 4"	96"	135"	81"	8,325	1,110	10,950	2,625	80	39	39

\*Split tanks

**Unloaded Vehicle Weight (UVW):** Sometimes referred to as "Dry Weight," UVW means the typical weight of this trailer as built at the factory. The UVW, as used in product literature and other promotional materials, does not include cargo, fresh water, propane, options or dealer-installed accessories.

**Gross Vehicle Weight Rating (GVWR):** GVWR means the maximum permissible weight of the trailer, including the UVW plus personal items, all cargo, fluids, options and dealer-installed accessories. The GVWR is equal to or greater than the sum of the UVW and the CCC.

**Cargo Carrying Capacity (CCC):** CCC means the maximum weight of personal items, food, fresh water, propane, tools, other cargo and dealer-installed accessories that can be carried by the trailer. CCC is equal to or less than GVWR minus UVW. The addition of options will decrease the CCC.

**Hitch Weight (HW):** The hitch weight, as used in product literature and other promotional materials, does not include cargo, fresh water, propane gas, options or dealer-installed accessories. The addition of these types of items will either add to or subtract from the stated hitch weight.

It is important for your safety and enjoyment that your tow vehicle be adequately sized and equipped to tow and handle the GVWR of the RV you select. Review weights and rating of your tow vehicle and consult a competent advisor for questions or advice. Whether you are new to RVing or a veteran, get a feel for the performance of your tow vehicle before heading out on the roadways. When you tow an RV, you must drive differently than when you drive a single vehicle. Practice hooking up, driving, backing up and braking in a safe environment or seek out professional instruction. Jayco affixes a weight label to each RV which lists weight information for that vehicle. See specifications chart above.

# JAY FLIGHT SLX AND JAY FLIGHT STANDARDS AND OPTIONS

	Jay Flight SLX (7-foot)	Jay Flight SLX (8-foot)	Jay Flight
<b>Exterior Equipment</b>			
I-Class™ cambered structural steel I-beams		S	S
3-inch cambered steel box tube frame	S		
Fully integrated A-frame	S	S	S
Front diamond plate	CVP	CVP	S
Power tongue jack			CVP
5/8-inch tongue-and-groove plywood floor decking		S	S
Magnum Truss™ Roof System with seamless DiFlex II material	S	S	S
2-sided, reflective foil insulation in flush-floor slideout floors		S	S
Large exterior downspouts	S	S	S
72-inch x 30-inch main entrance door			S
Large main entry door grab handle			ELITE
Entrance doors and baggage doors all Keyed-Alike™	S	S	S
Radial tires with galvanized steel, impact-resistant wheel wells	S	S	S
Goodyear® tires (made in the USA)	CVP	CVP	CVP
Front window with integrated rock guard	S		
Spare tire with cover	S	S	CVP
20-pound propane bottle(s)	S (1)	S (2)	
30-pound propane bottles (2) with cover			CVP
Solar prep			ELITE
Black tank flush			ELITE
Second fresh water tank (80-gallon total capacity)			ELITE
Power awning with LED light and integrated speakers	CVP	CVP	S
Pullout camp kitchen (242BHS, 284BHS, 294QBS, 24RBS)		S	S
Outside kitchen (std. on 29BHDB, 32BHDS, 32TSBH, 33RBTS; opt. on 31QBDS)			S
Outside shower		S	CVP
Utility lighting system			S
Aluminum rims			0
13,500-BTU roof-mounted A/C	0	S	CVP
15,000-BTU roof-mounted A/C		0	0 - CVP
30-amp service	S	S	S
50-amp service with second A/C prep (select models) (std. on 34RSBS, 294QBS, 324BDS)		0	0
Second A/C in bedroom (select models)			0
Electric stabilizer jacks (4)			0
Electric auto-leveling system			0
Cargo accessory receiver (n/a on 21QB, 26BH)			0

	Jay Flight SLX (7-foot)	Jay Flight SLX (8-foot)	Jay Flight
Chil N' Stor (245RLS, 26BH)		0	0
Bumper-mount outside grill			0
Patio door (29RKS, 29RLDS, 34RSBS) (std. on 38BHDS, 38FDSD)			0
Thermal Package: insulated, heated (n/a on 21QB and 26BH) and enclosed underbelly, 2-sided reflective foil insulation in main roof and slideout floors			0
Fiberglass sidewalls with frameless windows			0
Sani-Con® holding tank evacuation system		0	0
Roof ladder			0
Stabilizer jacks with sand pads	CVP (2)	CVP (4)	S (4)

<b>Interior Equipment</b>			
8,000-BTU wall-mounted A/C	S		
81-inch ceiling height		S	S
Wardrobe/pantry storage	S	S	S
Coat hook by entry door (select models)			S
Chocolate Maple cabinet doors	S	S	ELITE
Acrylic sink	S		
Large 50/50 acrylic kitchen sink		S	
Large 50/50 kitchen sink with pullout faucet			ELITE
Kitchen sink cover with drying rack			ELITE
2-burner range	S		
3-burner range with 9,000-BTU SuperBurner™ and piezo igniter		S	S
Range hood	CVP	CVP	S
Oven		S	
Stainless oven			ELITE
Vented kitchen window			S
Kitchen skylight with shade			0
LED accent lighting in kitchen			S
3-cubic-foot refrigerator with temperature controls	S		
6-cubic-foot Norcold® refrigerator with temperature controls		S	
8-cubic-foot refrigerator with stainless front (18-cubic-foot residential refrigerator in 38BHDS, 38FDSD)			ELITE
Microwave oven	S	S	
Stainless microwave oven			ELITE
Brushed nickel faucets	S	S	S
6-gallon gas water heater	CVP		
6-gallon gas DSI water heater		CVP	
6-gallon gas/electric DSI water heater (10-gallon in 38BHDS, 38FDSD)			CVP

## JAY FLIGHT SLX INTERIOR DÉCOR (8-FOOT-WIDE MODELS ONLY)

### HAVANA



### SMOKE



Jay Flight SLX (7-foot)  
 Jay Flight SLX (8-foot)  
 Jay Flight

Interior Equipment (Continued)	Jay Flight SLX (7-foot)	Jay Flight SLX (8-foot)	Jay Flight
Decorative dinette and slideout room lighting (SuperSlide models)			S
Vented windows in slideout room end walls (SuperSlide models)			S
Smoked-glass cabinet inserts (select SLX models)		S	S
Indoor/outdoor dinette table (select models)	S		
Up/down-style dinette table (main booth dinette only)			S
Freestanding table with 4 chairs (select models) (std. in 29RLDS)			O
DiamondFlor® vinyl flooring	S	S	S
Hidden-switch command/charging center			S
Backup/security camera prep			S
Dual USB/12V charging port			ELITE
Premium multimedia sound system with MP3/iPod® input jacks and Bluetooth® connectivity	S	S	
AM/FM/CD/DVD player with MP3 input and Bluetooth and HDMI® connectivity			ELITE
Residential-height plywood bed platforms	S	S	S
J-Steel™ jackknife sofa		S	S
Shaw® residential-grade carpet (select models)		S	S
Pleated window shades	CVP	CVP	S
Digital TV antenna	S	S	CVP
Cable/satellite TV hookup		S	CVP
Glass shower door (select models)			S
Marine toilet with foot flush	S	S	
Porcelain foot flush toilet			ELITE
Shower curtain with curved shower track (select models)	S	S	S
Tub surround		S	CVP
Bathroom skylight	CVP	CVP	CVP
Bathroom power fan			CVP
Wood-trimmed mirror in bathroom	S	S	
Queen Simmons® mattress (n/a on some 7-foot models)	S	S	S
Main bed struts			S
Queen bed struts		S	
300-pound-rated bunk beds (select models)	S	S	S
600-pound-rated bunk beds (double bunks)		S	S
Privacy curtains in bunk areas (select models)		S	S
Vented bunk windows (select models)			S
4-inch-thick bunk mats (select models)	S	S	S
Wooden bedroom doors (select models)			S
Sofa with folding bunk (33RBTS)			S

Jay Flight SLX (7-foot)  
 Jay Flight SLX (8-foot)  
 Jay Flight

King bed (34RSBS, 38BHDS, 38FDDS)			0
Front quad bunk (38BHDS)			0
Front queen bed (38BHDS)			0
Hide-a-bed with LED floor lighting (select models)			0
Rear sofa with folding bunk (33RBTS)			0
Bedspread with shams		0	S
Queen bedspread (195RB and all 8-foot models)	0	0	
28-inch LED TV (model-specific)		0	0
32-inch LED TV (model-specific)		0	0
39-inch LED TV (model-specific)			0
48-inch TV (mandatory in 34RSBS)			0
48-inch LED TV (284BHS)		S	
Fireplace (29RLDS, 33RBTS, 38BHDS)			0
Carpet in living area (34RSBS, 38FDDS)			0
Carpet in rear bedroom (32TSBH)			0
Multifunctional digital remote			0
Water heater bypass	CVP	CVP	CVP

S - Standard      CVP - Customer Value Package (mandatory option)  
 O - Optional      ELITE - Elite Package (mandatory option)

## ELITE PACKAGE

- **Black tank flush**
- **Second fresh water tank (80-gallon total capacity)**
- **Large main entry door grab handle**
- **8-cubic-foot refrigerator with stainless front (18-cubic-foot residential refrigerator in 38BHDS and 38FDDS)**
- **Large 50/50 kitchen sink with pullout faucet**
- **Upgraded kitchen sink with cover and drying rack**
- **Porcelain foot flush toilet**
- **Stainless microwave oven**
- **Stainless oven**
- **Chocolate Maple cabinet doors**
- **AM/FM/CD/DVD player with MP3 input and Bluetooth and HDMI connectivity**
- **Solar prep**
- **Dual USB and 12V charging port**

## JAY FLIGHT INTERIOR DÉCOR

### SADDLE



### DUNE

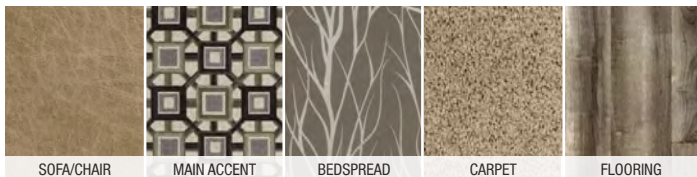

### TUMBLEWEED



### CANYON

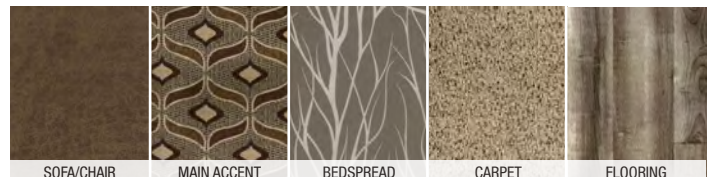

# TAKE A RIDE ON THE CAREFREE SIDE

Designed for camping comfort and convenience, Jayco RVs provide an easy-going, family-fun experience that relieves your stress. With countless features and reliable construction, you'll breathe easy no matter where your adventures take you and yours.



## THE JAYCO DIFFERENCE

1. **Hand-tucked and glued fiberglass insulation** increases the insulation value near the 2-inch x 2-inch wooden studs; competitors use a blanket-insulation technique
2. **An optional fiberglass package** offers a smooth, sleek look; front walls are vacuum-bonded for added durability, while the sidewalls and rear walls are pinch rolled, for an affordable combination
3. **Magnum Truss™ Roof System** withstands 4,500 pounds—50 percent more than other roofs; by using 3/8-inch plywood decking screwed down at every seam, we offer higher durability than competitors' stapled construction; a one-piece, sidewall-wrapped DiFlex II material provides the ultimate in leak protection
4. **Durable floors** feature 5/8-inch tongue-and-groove plywood (n/a on 7-foot Jay Flight SLX) on 2-inch x 3-inch wooden joists, wrapped with a protective moisture barrier to keep the elements at bay
5. **Galvanized steel wheel wells**, not found on competing models, reduce heat loss and prevent damage in case of road debris
6. **Integrated A-frame** with I-beams forged as one, not welded; adds more strength and durability to the frame foundation and prevents the hitch from buckling
7. **Dual-sided reflective foil insulation**, rated at R-15, available in slideout floors and main roof

## JAYCO'S ROOF **vs** OTHER ROOFS



4,500 POUNDS ON A JAYCO ROOF VS. OTHER ROOFS

THE MAGNUM TRUSS ROOF SYSTEM  
**50 percent stronger**

WE START WITH ONE OF THE INDUSTRY'S  
**strongest**  
**foundations**

Many competitors modify or weld stock frames, which can weaken the integrity of your foundation. Jayco's custom-manufactured frames offer higher strength and durability.

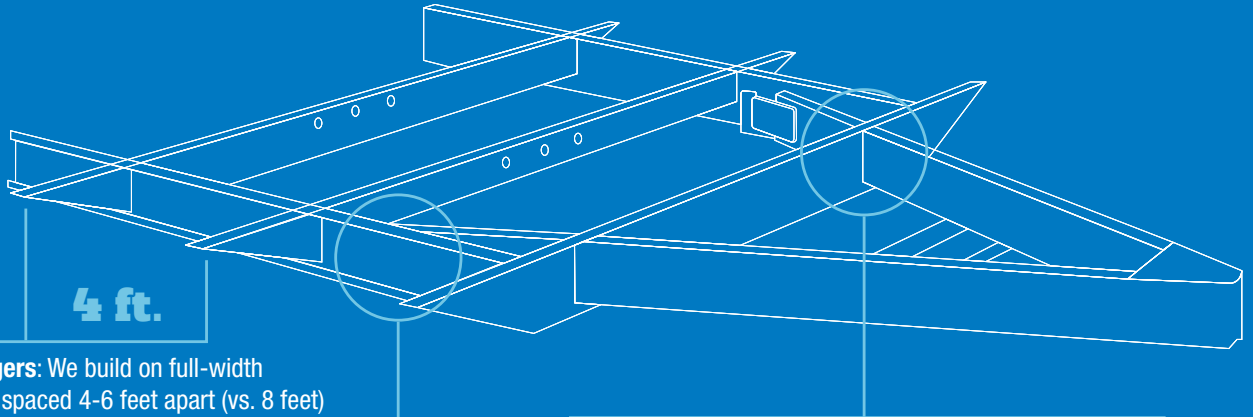

**Full-width outriggers:** We build on full-width outriggers that are spaced 4-6 feet apart (vs. 8 feet) to better support the weight of the wall.

**I-Class™ cambered structural steel I-beams:** Jayco uses a unique molded, one-piece design to prevent the unit from twisting; competing three-piece I-beams can warp over time at the welded seams.

**Integrated A-frame:** The A-frame runs through the main frame, preventing the hitch from buckling—a common issue in competing tack-welded designs; seasonal travel trailers have a detachable hitch in lieu of an integrated A-frame.

Learn more at [StrongFoundation.Jayco.com](http://StrongFoundation.Jayco.com)

**GOODYEAR® TIRES NOW FEATURED ON ALL 2018 JAY FLIGHTS**

**Optimized tread depth and decoupling groove** help tire to remain cool while towing heavy loads

**Durawall® Technology** helps resist cuts and punctures to sidewalls

**Scuff guard** helps provide sidewall protection

**Rugged fabric-steel construction**

**Specialized inner liner** minimizes air loss in trailer applications because of 100% halobutyl rubber

**6-year limited warranty** from Goodyear on tire workmanship and materials

**Offers improved durability and carrying capacity** while remaining compatible with tire pressure monitoring systems and typical tire inflation stations



# JAY FLIGHT

Highly towable, seriously fun



## Jay Flight (fiberglass option pictured)

Lengths: 25' to 40'; Weights: 4,425 to 8,765 lbs.



## Jay Flight SLX (single-axle)

Lengths: 16' to 22'; Weights: 2,410 to 2,960 lbs.



## Jay Flight SLX (double-axle)

Lengths: 25' to 36'; Weights: 4,155 to 7,615 lbs.



Generations of family fun.

Meet your Jayco Dealer

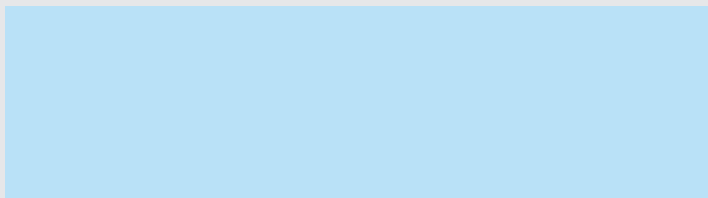

We work hard—so you can play hard. From finding the perfect Jayco for your family to providing flexible financing options and full-service support, we're here to help.

Follow Jayco



Jayco, Inc. | P.O. Box 460 | Middlebury, IN 46540

See dealer for further information and prices. All information in this brochure and on [www.jayco.com](http://www.jayco.com) is the latest available at the time of publication approval. Jayco reserves the right to make changes and to discontinue models without notice or obligation. Photography may show optional equipment or props used for decoration purposes only. RVs built for sale in Canada may differ to conform to Canadian codes. JAYCO and the JAYCO BIRD IN FLIGHT are registered trademarks of Jayco, Inc. Printed in USA 20K 1/18 ©2018 Jayco, Inc. 274776-1

## Travel with Confidence



At Jayco, we build our RVs to handle every adventure, then back them with our industry-leading 2-year limited warranty. We, with support from our select partners, have you covered for **2 camping seasons**. That's **730 days**. You won't find a better warranty in the business, because the only strings we attach are those that deliver the ultimate in reliability. That's the Jayco difference. So go explore. For a copy of our 2-year limited warranty with complete terms and conditions, please contact your local Jayco dealer.



MADE IN USA



Featuring Durawall® Technology—ENGINEERED to help you tow with confidence

## eco advantage™

Jayco's long-term commitment to generations of family fun

After six years of increased efforts to eliminate waste, conserve energy and increase recycling, we've come a long way in building RVs that are not only better for your family—but also better for the planet.

Learn more at [Jayco.com/EcoAdvantage](http://Jayco.com/EcoAdvantage)