

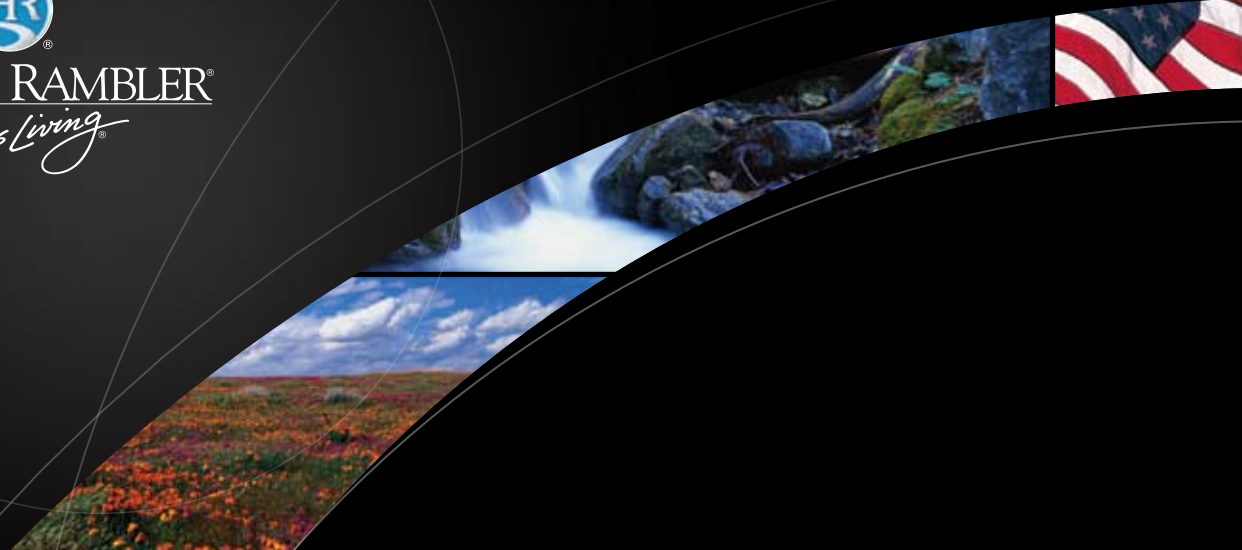

HOLIDAY RAMBLER®

This is Living®



HR NAVIGATOR®

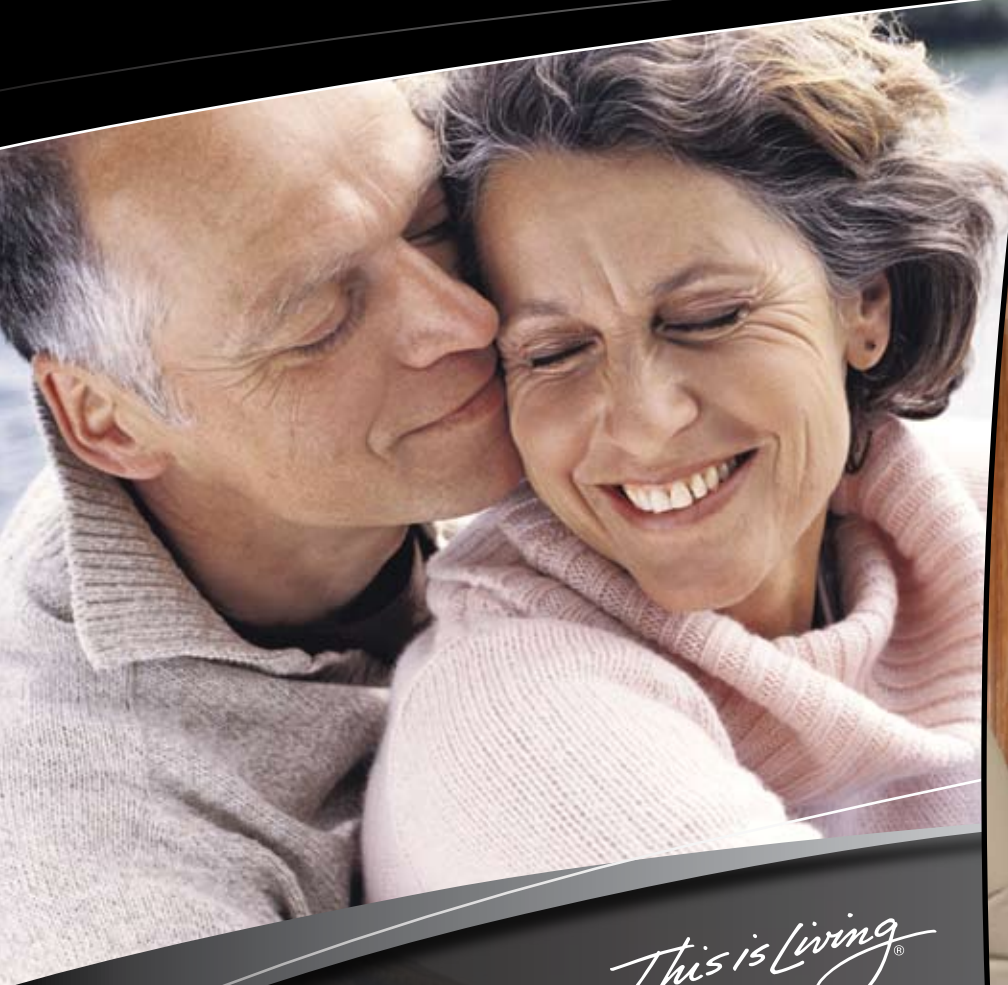

This is Living®





45PBQ | STAINED CHERRY | COPPER CANYON

WELCOME TO THE ROAD LESS TRAVELED.

You've never settled for second best. Not content to go along with the pack, you trust your own instincts and forge paths for others to follow. And now the time has come for you to celebrate your success with the most distinctive RV available. The 2007 Navigator from Holiday Rambler.

Luxurious and spacious, the Navigator combines awe-inspiring technology and commanding power with lavish comfort and astonishing beauty.

The result is an engineering marvel that's perfectly suited for your vision of the road less traveled.

SMOOTH OPERATOR. The Navigator's size is impressive but never overwhelming, thanks to an innovative full-cushion Air Glide suspension featuring ten Bilstein® shock absorbers and ten air bags – including eight that are outboard mounted. Outboard mounting ensures a smooth ride and easier handling so you can drive with complete confidence.





45PBQ | STAINED CHERRY | COPPER CANYON

MORE THAN YOU'VE EVER IMAGINED.

If we had to describe the 2007 Navigator in one word, it would be "more." There's more space with an increased interior height of 84" for a full seven-foot ceiling height. There's more style with a stunning mirrored and lighted ceiling, added angles and accent columns, a tile aisle from the cockpit and sculptured carpet in the living area. And there are more luxuries that come standard – little indulgences like leather J-lounge seating to full-blown extravagances like our exclusive PanaSuite™ full-wall slides for a more residential feeling.

LET US ENTERTAIN YOU. Navigator offers more entertainment with two standard televisions, including a 37" LCD ceiling-mounted home theater system with DVD and CD player. Plus, exterior TVs are available on floorplans with patio slide-outs. And with an electric TV antenna and a fully automatic digital satellite system, you'll get great reception anywhere. Now who could ask for anything more?





45PBQ | STAINED CHERRY | COPPER CANYON

WHY SETTLE FOR LESS?

In your everyday life you wouldn't dream of settling. So why should life on the road be any different? With Navigator, you'll never do without. Just look at this kitchen – lots of room, beautiful natural oak cabinetry, modern appliances, surround sound speakers, Corian® countertops, the list goes on and on. You even have the option of adding a full-size, residential refrigerator to truly make you feel at home. And once you sit down to eat, you'll enjoy more room there as well. We've raised the dimensions

on the legless dinette wall cabinet and table for increased leg room.

A PLACE FOR EVERYTHING. There's always room for everything you need with ample cabinets and drawers featuring low-friction guides and beautiful pearl nickel and polished brass hardware. Certain models also feature a convenient pullout pantry with a durable cutting board and built-in storage for countertop covers.





45PBQ | STAINED CHERRY | COPPER CANYON

ALL THE COMFORTS OF HOME – AND THEN SOME.

Navigator nights are all about relaxation. First, create a tranquil atmosphere with the day/night shades with blackouts. Then retire to the spacious bedroom and unwind while watching the 20" LCD television or enjoying the rich sound of the Bose® Wave radio. You can even add a ceiling fan to create the ideal sleeping climate. It's all only a touch away with a multiplex switch right next to the bed. Finally, you'll be lulled to sleep by the coziness of a pillowtop mattress on the standard queen or optional king-size bed, dreaming of tomorrow's adventure.

OPULENCE IN EVERY CORNER. Tucked into the private area of the Navigator, you'll find just as much luxury. Bedroom closets, wardrobes and dressers that are roomy and functional. Bathrooms that offer a surprising amount of space and storage options. And with tile floors and Corian® integrated sinks and shower walls now featuring a stylish tile accent, you'll find bathroom cleanup especially easy.

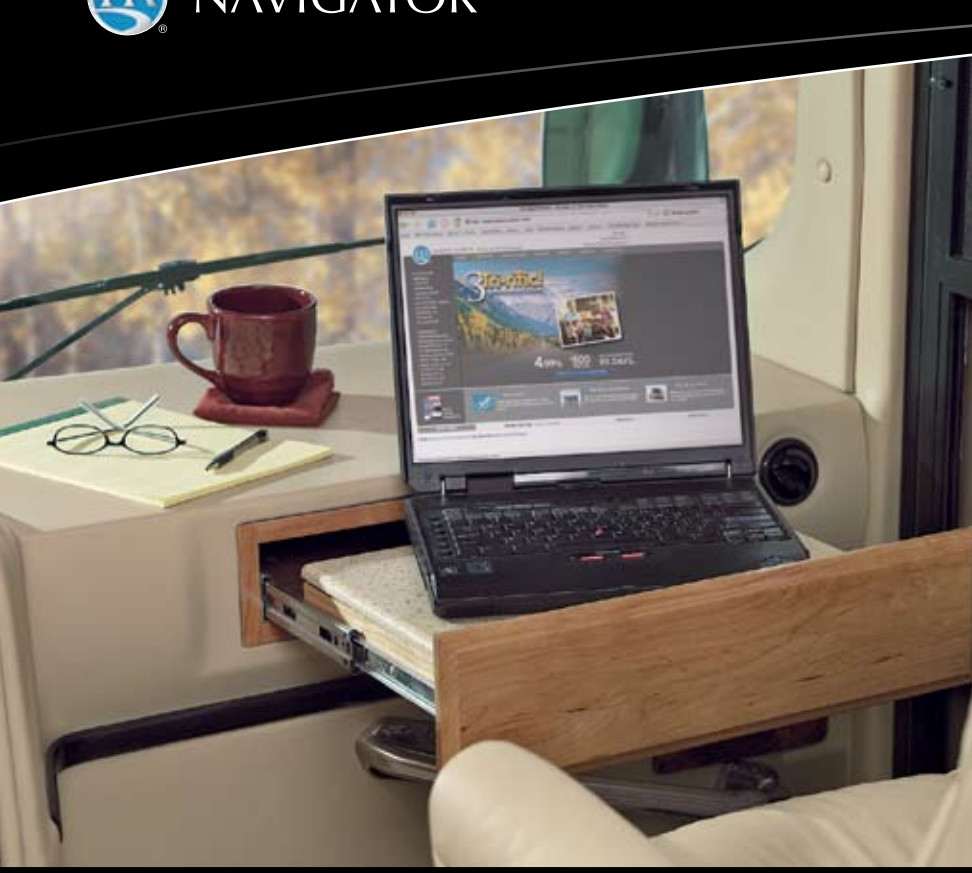

This is Living®

▶▶ PANAVIEW™

1-PIECE WINDSHIELD



45PBQ | STAINED CHERRY | COPPER CANYON

THIS IS WHERE YOU BELONG.

As you slip into the driver's seat, you feel it. A sense of belonging. It starts with incredible comfort – 6-way power seats, adjustable arms, electric heat and lumbar settings – even the brake and accelerator pedals are adjustable. Feel the power as you take hold of the lighted, 4-spoke VIP Smartwheel® designed to put everything right at your fingertips. Your co-pilot will enjoy the convenience of the slide-out workstation. And together, you'll find the miles pass by pleasantly with the AM/FM stereo with multi-disc CD player

or the optional CB radio and satellite radio system. Now this is the way to go.

ENJOY THE VIEW. You won't miss a thing with the impressive PanaView™ 1-piece windshield. Once you arrive, you can continue to take in the scenery with our standard Girard® automatic roof-mounted patio awning. It creates an ideal setting for making the most of the great outdoors. And with Navigator's impressive storage capabilities, you can bring whatever you need along for the ride.

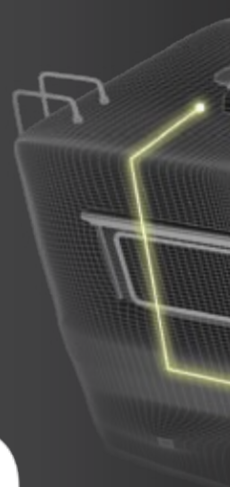

INTELL-I-SWITCH
Innovating Convenience.



Bundles of wiring are replaced by separate modules that communicate with each other through a single wire. This reduces the overall weight of the coach and makes servicing much easier.

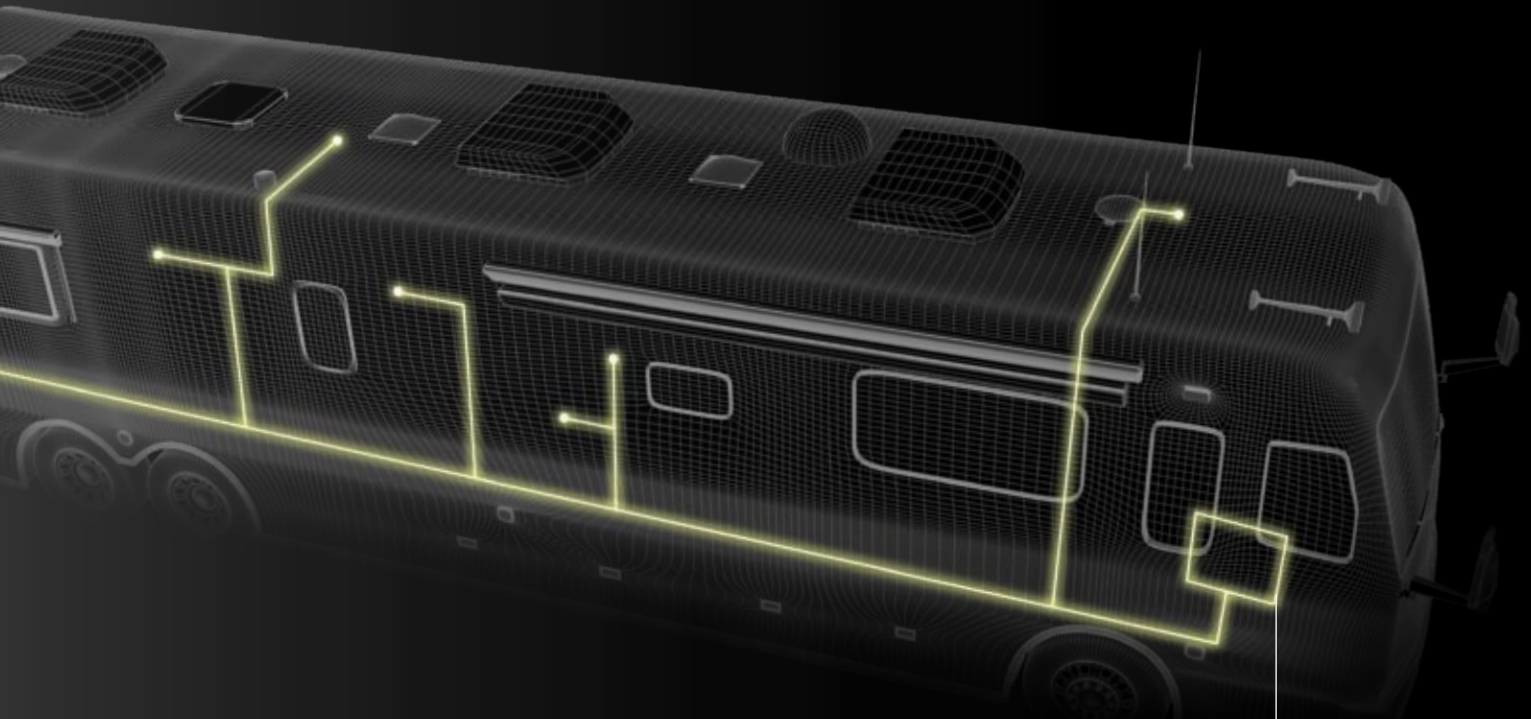

AN IDEA SO SIMPLE,
IT'S AHEAD OF ITS TIME.

Monaco Coach is proud to be among the first to offer sophisticated Multiplex wiring. This state-of-the-art system utilizes computer technology to streamline the wiring and connect many of the coach's electronic features. This illustration explains how it works, but all you really need to know is that you're going to love the convenience.

Lighted switch panels, like the one shown here, are located throughout the coach, giving you multiple convenient access points for the controls to the slide-outs, lighting and more. Each switch illuminates to indicate which function is on or off.



THE INNOVATIONS JUST KEEP ROLLING ON.

Somehow, we've managed to outdo even ourselves with the Navigator. Multiplex wiring and Intelli-Switch technology for added convenience. A 3M® film front mask for added protection against nicks. Dropped storage bays for added storage space. Super Service Center for easier access to hook-ups. A standard Aqua-Hot® system for unlimited on-demand hot water. And, one of our favorite advancements, the ingenious PanaSuite™ full-wall slide. You won't believe the difference it

makes, creating a roomy and uninterrupted space for a truly residential look and feel. All we can say is, welcome home to the new 2007 Navigator.



A STYLE ALL YOUR OWN.

From Mocha Java to Pralines and Cream, Holiday Rambler gives you delicious choices of color schemes. Take your pick and make your Navigator a traveling showcase for your own unique tastes.

- A. BEDSPREAD
- B. SOFA
- C. ACCENT
- D. CARPET

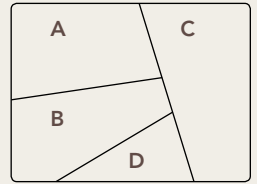

MOCHA JAVA



COPPER CANYON



NAVIGATOR HARDWARE

Great design can be found in the details, like our stylish cabinet hardware with a pearl nickel and polished brass finish.



Manufactured in, not added on. For added protection against stains, soil repellent is applied to virtually all upholstery fabric during the finishing process for superior coverage.*

*Brand and application of upholstery fabric protection may vary depending on date recreational vehicle was manufactured.



NATURAL OAK



STAINED OAK



NATURAL MAPLE



NATURAL CHERRY



STAINED CHERRY



STONINGTON GRAY



PRALINES AND CREAM

1 The three-point engine mounting system lowers the coach's center of gravity and reduces the amount of vibration that reaches the coach. The mounting also makes the engine easier to service by allowing the engine to be easily lowered through the bottom of the coach.

2 10,000 lb. hitch receiver offers powerful towing capacity.

3 Cushion Air Glide suspension system includes ten Bilstein® shocks and ten air bags, eight of which are outboard mounted with auto-leveling for greater stability, a smoother ride and the best handling in its class. Unique three-degree rear axle tilt perfectly aligns the engine, transmission and differential, minimizing stress on the drivetrain and reducing noise in the coach.

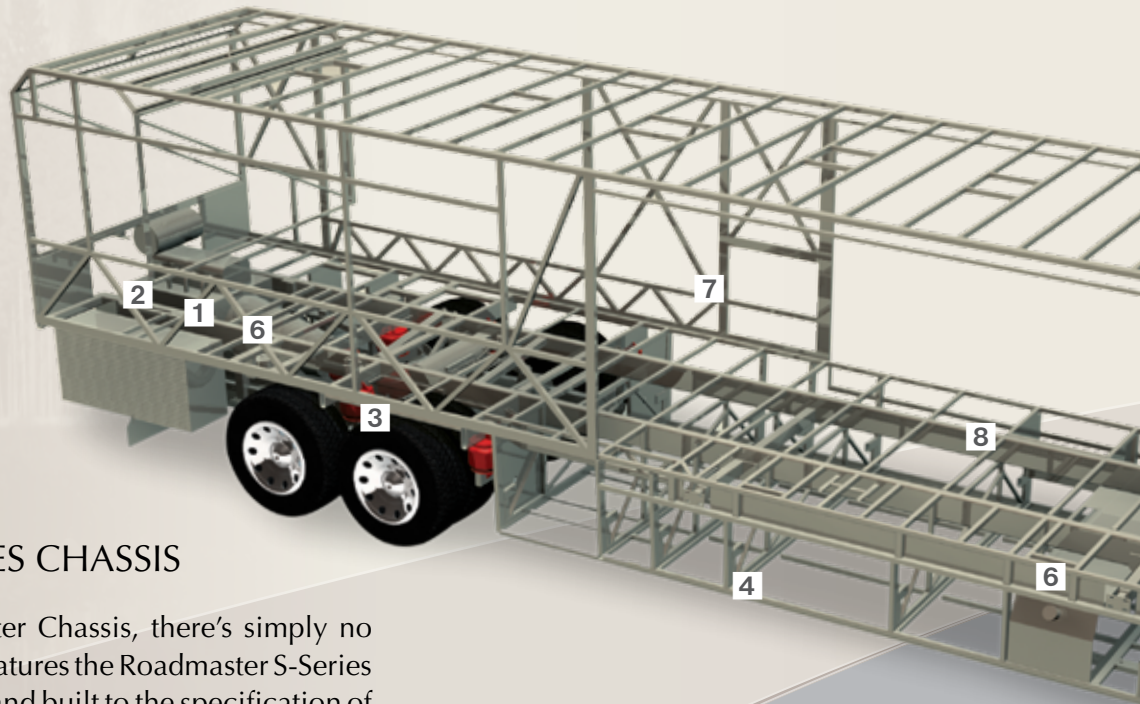

ROADMASTER S-SERIES CHASSIS

When it comes to Roadmaster Chassis, there's simply no comparison. The Navigator features the Roadmaster S-Series Semi-Monocoque chassis. Hand built to the specification of each floorplan, this masterpiece of engineering and design delivers at every level – safety, dependability, stability and strength...not to mention comfort, maneuverability and convenience. Just take a look at some of what makes these one-of-a-kind chassis so impressive.



ROOF CONSTRUCTION (top to bottom)

- One-piece 1/4" thick fiberglass roof, crowned for water runoff and seamlessly joined with front and rear end caps; non-skid walkways on outboard areas for added convenience
- Vapor barrier
- Tapered bead foam supports the crowned roof; the center tunnel houses wiring and air conditioner ducts
- Marine grade plywood sheeting
- Tubular steel framework
- Foam insulation
- Luaun and vinyl paneling are Vac-U-Bonded
- Sound-absorbing, easy-to-clean padded vinyl interior headliner

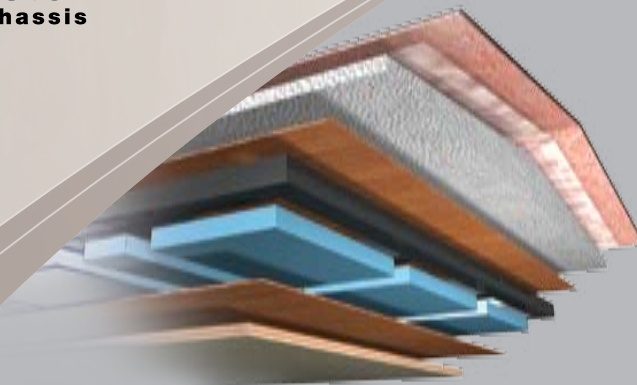

Automatic Traction Control (ATC) eliminates wheel slippage in slick conditions and heightens control.



Tag axle lifts for added maneuverability in tight spots.

4 Basement structure rust inhibitor: To prevent corrosion, the basement storage area is constructed with pre-primed steel with rust-inhibiting paint.

5 Dual fuel fill allows you to fill the tank from either side of the coach, for greater convenience and flexibility at the pump.

6 Allison® 4000 MH 6-speed transmission for smooth shifting; our exclusive use of synthetic transmission fluid allows for up to three-year maintenance intervals.

7 The semi-monocoque design, with trussed superstructure, distributes stress evenly throughout the entire chassis and adds strength to sidewalls and bays.

8 Full-length frame rails fabricated from 3" by 8" by 1/4" 60,000 PSI structural steel; rails are spaced 44" on center for a wider stance and unmatched strength.

9 Two-stage Jake brake system assures you of safely traveling steep grades while 6-wheel anti-lock brakes with disc brakes in front help you maintain control in severe road conditions.

10 P295/80R/22.5 Goodyear steel-belted all-season tires ensure a safe and quiet ride.

11 All chassis are equipped with steel cage construction and steel firewall for added safety.

12 The power steering box allows for a 50-degree front wheel turn angle in both directions for better maneuverability and returns the steering wheel back to its center position to eliminate driver fatigue.

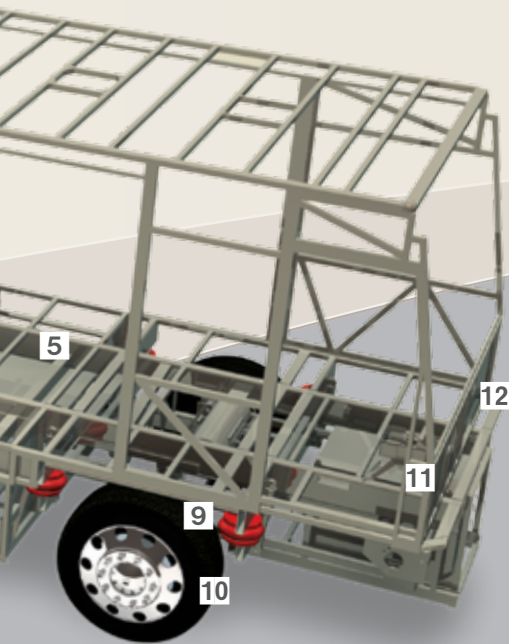

This optional collision avoidance system utilizes a combination of sensors, software and radar to warn you of potential hazards in the road ahead.



Aladdin™ makes it easy to keep track of many important functions, including tank levels, temperatures, mileage and much more.



With the GPS option, you're free to explore the middle of nowhere and always know exactly where you are.



The optional SEE-Vision system reduces blind spots when you're driving and provides added security when you're parked.

SIDEWALL CONSTRUCTION (left to right)

- Gel coat fiberglass outer wall
- Luaun paneling
- R 7.5 closed cel foam seals every nook and crevice
- Heavy-gauge tubular steel and steel plate backers for cabinet attachment
- Luaun paneling; walls are Vac-U-Bonded together
- Decorative vinyl wall coverings



FLOOR CONSTRUCTION (top to bottom)

- Plywood and tile, or carpet pad and carpeting
- Oriented Strand Board (OSB)
- Decibel paper
- Oriented Strand Board (OSB)
- Waterproof Darco underbelly

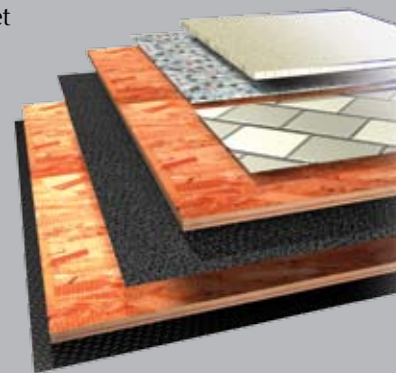



BODY CONSTRUCTION: FEATURES

- Heavy-Duty Steel Superstructure with Steel Cage Cockpit Construction
- Seamless One-Piece Molded Crowned Fiberglass Roof
- All-Season Foam Insulated Roof
- Laminated Gel Coat Fiberglass Sidewalls
- Five-Layer Flooring with Two Layers of OSB Flooring
- Deluxe Full-Body Paint
- Panaview™ 1-Piece Front Windshield
- Triple Head Power Controlled Heated Chrome Exterior Mirrors with Turn Indicator Lights
- Halogen Fog Lamps
- Daytime Running Lights
- Recessed Side Docking Lights
- Dual Trumpet Air Horns
- Entry Step Storage
- Insulated Aluminum Baggage Doors with Power Locks
- Lined Pass-Through Storage Compartments
- Interlocking Aluminum Framed Slide-Out Houses
- Interior Paneling with 1 1/2" Insulation
- Side-Hinged Baggage Doors with Electric Locks

- Rear Ladder
- Holiday Rambler Full-Length Mud Flap with Polished Stainless Steel Logo
- 3M® Film Front Mask

OPTIONS

- Slide-Out Storage Trays — Complete Pass-Through
- Electric Slide-Out Storage Trays — Complete Pass-Through
- Interior Sunscreens

CHASSIS/ENGINE/SUSPENSION: FEATURES

- Roadmaster S-Series Semi-Monocoque Chassis
- Cummins® ISM-II 500 HP Electronic Engine with Allison® 4000 MH 6-Speed World Transmission and Electronic Shifter
- Torque: 1,550 lbs./ft. Max
- Engine Displacement 661"/10.8L
- Dual Fuel Fill
- 200 Amp Alternator
- Rear Axle Ratio: 4.33:1
- Tires: Goodyear 295/80R/22.5
- Polished Aluminum Wheels
- Full-Cushion Air Glide Suspension with Ten Outboard-Mounted Air Bags and Ten Bilstein® Shock Absorbers
- Air Suspension with Two Ping Tanks
- Automatic Traction Control
- Anti-Locking Braking System with Front Disc Brakes and Rear Drum Brakes
- Tag Axle with Anti-Lock Braking System
- Auto Slack Adjusters on Brakes
- Two-Stage Jacobs Engine Brake
- Pre-Wire for Supplemental Braking System
- Engine Block Heater with Switch on Dash
- Automatic Air Leveling System
- Undercoating
- 10,000 Lb. Hitch Receiver and 7/4-Way Trailer Plug
- Remote Inflation Connector

OPTIONS

- Series 60 Detroit Diesel 515 HP Engine with Allison® 4000 MH 6-Speed World Transmission and Electronic Shifter; Torque: 1,650 ft./lbs.; 858 Cu. In. Engine Displacement
- Cummins® ISX-525HP Engine with Allison® 4000 MH 6-Speed World Transmission and Electronic Shifter; Torque: 1650 ft./lbs.; 912 Cu. In. Engine Displacement (Forced Option)
- Hydraulic Leveling System (Replaces Standard Air Leveling System)
- Dual Leveling Systems (Air/Hydraulic)

COCKPIT: FEATURES

- Fiberglass Automotive Dash with Vermillion Burl Instrumentation Panel; Black Gauges with White Lettering and Chrome Bezels
- In-Dash Stereo with AM/FM Stereo with Multi-Disc CD Changer
- Color Rear Vision System with Audio
- Aladdin™ Video Coach System with SEE-Vision Security Cameras, Integrated Compass and Temperature Gauge
- CB Radio Prep (Cable and Antenna)
- Recessed Slide-Out Dash Workstation
- Manual Privacy Drape
- Power Front Sunvisors
- Pilot and Co-Pilot Side Window Manual Sunscreens
- Adjustable Brake and Accelerator Pedals
- Lighted VIP Smartwheel®
- Audible Turn Signals
- Cruise Control Light on Dash
- 6-Way Power Pilot and Co-Pilot Seats with Electric Heat and Lumbar; Electric Sliding Seat Cushion and Memory Capabilities on Pilot Seat; Power Footrest on Co-Pilot Seat
- 12V and 110V Outlet at Dash
- Carpeted Driver and Passenger Floor Mats

OPTIONS

- Electric Privacy Drape
- CB Radio
- GPS Navigation System
- XM Satellite Stereo (Requires Subscription)
- Sirius Satellite Radio System (Requires Subscription)

APPLIANCES AND ACCESSORIES: FEATURES

- Four-Door Refrigerator with Ice Maker and Raised Panel Doors
- Recessed High-Output Two-Burner Cooktop with Flush-Mount Covers
- Spacesaver Convection Microwave with Touch Control
- Electric TV Antenna
- Fully Automatic Digital Satellite System with Second Receiver for Bedroom
- 37" LCD TV Mounted in Living Area Ceiling
- 20" LCD TV in Bedroom
- Bose® Wave Radio in Bedroom
- Home Theater System with DVD/CD Player
- Bedroom DVD Player
- Universal Remote System for Living Area TV

OPTIONS

- 14 Cu. Ft. 2-Door Refrigerator with Water and Ice Dispenser in Door
- Residential Refrigerator with Four Additional Batteries
- Combination Washer/Dryer
- Stackable Washer/Dryer
- Central Vacuum System
- In-Motion Digital Satellite System with Second Receiver for Bedroom
- In-Motion Digital Satellite System with HD-Ready Receiver (HD N/A on Bedroom TV)
- Exterior 32" LCD TV (N/A on Floorplans without Patio Slide-Out)

INTERIOR: FEATURES

- Stained or Natural Oak Cabinetry
- Lined Cabinet Shelves
- Dinette Wall Cabinet with Corian® Top
- Built-In Storage Area for Kitchen Countertop Covers
- Bedroom Dresser
- Clothing Hamper in Bedroom
- Low-Friction Roller Drawer Guides
- Recessed Ceiling Design
- Corian® Countertops Throughout
- Integrated Corian® Sinks in Vanity and Galley
- Corian® Backsplash above Kitchen Countertop
- Glass Splash Guard at Living Room Side of Kitchen Countertop
- Day/Night Shades with Blackouts Throughout
- Mini Blinds in Kitchen and Bathroom
- Wallpaper Throughout
- Four-Compartment Drawer Organizer in Galley
- Tile Aisle from Cockpit to Galley Area with Sculptured Carpeting on Each Side in Living Area
- Ceramic Tile in Kitchen and Bath
- Ceramic Tile Flooring in Cockpit Area
- Raised Panel Door for Private Bath
- Bedspread and Pillows
- Nightstands with Corian® Countertops
- Corian® Windowsills in Living Area
- Recessed Galley Area Surround Sound Speakers in Ceiling
- Pearl Nickel/Polished Brass on Hardware Throughout
- Decorative Hardwood Slide-Out Fascia

OPTIONS

- Interior Decors: Mocha Java, Copper Canyon, Stonington Gray, and Pralines and Cream
- Stained or Natural Cherry Cabinets, or Natural Maple Cabinets
- Ceiling Fan in Bedroom
- Powered Blinds Living Area (N/A on Slide-Out Endwall Windows)
- Plank Flooring in Kitchen and Bath

FURNITURE: FEATURES

- Legless Side-Slide Corian® Dinette Table with Two Freestanding Dinette Chairs and Two Folding Chairs
- Roadside: Fabric Jackknife Sleeper Sofa
- Curbside: Leather J-Lounge
- Additional Bedroom Wardrobe (N/A: 40PBTF, 40PBQ)
- Queen Bed with Pillowtop-Hinged Mattress

OPTIONS

- King Bed
- King Air Mattress with Remote
- Roadside: Computer Table with Leather Euro-Recliner and Ottoman
- Roadside: Leather Hide-A-Bed
- Roadside: Leather Hide-A-Bed with Air Mattress (N/A: 40PBTF, 40PBQ)
- Curbside: Leather Jackknife Sleeper Sofa
- Roadside: Leather Jackknife Sleeper Sofa
- Bedroom Desk and Chair with Pullout Ottoman (43PBQ)
- Fabric/Leather Sectional Booth Dinette Ensemble (Requires New Galley)

ELECTRICAL SYSTEMS AND LIGHTS: FEATURES

- 50 Amp 120/240V Distribution Panel and Power Cord with Quick Disconnect
- Power Cord Reel
- Onan® 10 kW QD Diesel Generator on Power Slide-Out Tray with Auxiliary Start Switch and Automatic Temperature Start
- 2,800 Watt Pure Sine Wave Inverter with Automatic Gen Start and Automatic Temperature Start
- Pilot and Co-Pilot Map Lights
- Decorative Lighting in Living Area and Bedroom
- Cosmetic Vanity Lights in Bathroom
- Switches for Bedroom with Decorative Lights on Both Sides of Bed
- Recessed Halogen Lighting under Living Room and Dinette Overhead
- Halogen Lighting in Ceiling Throughout
- Accent Rope Lighting Throughout Coach
- Lighted Utility Center
- Underhood Utility Light
- 120V Outlet in Private Bath
- 120V Outlet in Bed Base
- 120V Receptacles in Outside Storage Compartment
- Porch Light
- Doorbell
- Lighted Exterior Storage Compartments
- Four 6V Deep Cycle House Batteries
- Two 12V Deep™ Cycle Chassis Batteries
- Surge Guard™ Automatic Transfer Switch
- Multiplex 12V Wiring for Dash/Instrument Panel Gauges and Interior of Coach
- Computer Wiring in Dinette Cabinet
- Locking Battery Disconnect Switch inside Coach
- Powder-Coated Generator Exhaust Pipe
- Emergency Start Switch
- Electronic Controls in Passenger Overhead
- Multiplex Switches Throughout Coach
- Rope Lighting in Living Room and Bedroom Valances; Under Galley and Bedroom Toe Kicks Courtesy Lighting in Stepwell and Bedroom
- Front and Rear Electrical Run Boxes
- 12V Distribution Panel
- Switch in Bedroom for Docking Lights

OPTIONS

- Solar Panel

PLUMBING AND LP SYSTEMS: FEATURES

- Central Water Filtration System in Service Bay
- Manabloc Water System for Entire Coach
- Insulated Systems Compartment with Easy Access to Hook-Up
- Water Pump Switch in Galley, Bathroom and Service Bay
- China Toilet
- Super Service Center
- Corian® Shower with Tile Accent and Shower Caddy
- RV Sani-Con Tank Drainage System
- Shower Head Volume Control
- Black Holding Tank Rinsing System
- Outside Faucet with Hot and Cold Water
- Power Water Hose Reel
- Soap Dispenser in Kitchen

OPTIONS

- Insta-Hot® Water System
- Bathtub (N/A: 40PBTF, 40PBQ)

HEATING, VENTS AND AIR CONDITIONING: FEATURES

- Aqua-Hot® Heating System
- Two Low-Profile Ducted 15,000M BTU Roof A/Cs with Wall Thermostat and Heat Pump (40PBTF, 40PBQ)
- Three Low-Profile Ducted 15,000M BTU Roof A/Cs with Wall Thermostat and Heat Pump (43PBQ, 45PBTF, 45PBQ)
- Electronic AC/Heat Climate Control System
- Center Defroster Vents
- 12V Attic Fan with Wall Thermostat in Bathroom, Private Lavatory and Kitchen

OPTIONS

- One Low-Profile 110V Baseboard Heater (in Galley)

H O L I D A Y R A M B L E R . C O M

Log on to our website anytime, night or day. It's your link to everything Holiday Rambler, including product news and updates, club events, dealer and service center info and much more. Take it for a test drive today.



WINDOWS, DOORS AND AWNINGS: FEATURES

- Flush-Mounted Radius Dual Pane Safety Glass Dark Tinted Windows
- Front Entry Door with Air Seal and Removable Top Screen
- Keyless Remote Entry System with Pocket Remote
- Tinted Skylight in Bathroom
- Topper Awnings on Slide-Out Houses
- Roof-Mounted Girard® Automatic Front Patio Awning

OPTIONS

- Girard® Automatic Front Door Awning
- Girard® Automatic Window Awnings
- Roof-Mounted Girard® Automatic Rear Patio Awning

SAFETY: FEATURES

- Back-Up Alarm
- Fire Extinguisher
- Deadbolt Lock on Entrance Door
- Lighted Interior and Exterior Grab Handles
- 120V GFI Protected Circuit (Kitchen, Bath, Service Bay)
- LP Gas Detector
- Smoke Detector
- Carbon Monoxide Detector
- Integrated Pilot and Co-Pilot Three Point Seatbelts
- Third Brake Safety Light
- Egress Windows

OPTIONS

- Security Safe
- Deluxe Security Alarm System
- Collision Avoidance System

| Weights (Lbs.)* | 40PBTf | 40PBQ | 43FST | 43PBQ | 45PBTf | 45PBQ |
|----------------------------------|--------|--------|--------|--------|--------|--------|
| Gross Vehicle Weight Rating | 48,160 | 48,160 | 48,160 | 48,160 | 48,160 | 48,160 |
| Gross Combined Weight Rating | 58,160 | 58,160 | 58,160 | 58,160 | 58,160 | 58,160 |
| Gross Axle Weight Rating (Front) | 15,160 | 15,160 | 15,160 | 15,160 | 15,160 | 15,160 |
| Gross Axle Weight Rating (Rear) | 23,000 | 23,000 | 23,000 | 23,000 | 23,000 | 23,000 |
| Tag Axle Weight Rating | 12,000 | 12,000 | 12,000 | 12,000 | 12,000 | 12,000 |

Measurements

| | | | | | | |
|---|---------|---------|---------|---------|---------|---------|
| Wheelbase | 245" | 245" | 269.5" | 269.5" | 281.5" | 281.5" |
| Overall Length | 40' 10" | 40' 10" | 43' 10" | 43' 10" | 44' 10" | 44' 10" |
| Exterior Height (12'8" to Top of Satellite) | 12' 6" | 12' 6" | 12' 6" | 12' 6" | 12' 6" | 12' 6" |
| Interior Height (Increased Height to 84") | 84" | 84" | 84" | 84" | 84" | 84" |
| Interior Width | 96" | 96" | 96" | 96" | 96" | 96" |
| Exterior Width | 100.5" | 100.5" | 100.5" | 100.5" | 100.5" | 100.5" |

Tank Capacity (Gal.)**

| | | | | | | |
|------------|-----|-----|-----|-----|-----|-----|
| Gray Tank | 56 | 56 | 56 | 56 | 56 | 56 |
| Black Tank | 56 | 56 | 56 | 56 | 56 | 56 |
| Fresh Tank | 100 | 100 | 100 | 100 | 100 | 100 |
| Fuel Tank | 150 | 150 | 150 | 150 | 150 | 150 |
| LP Tank*** | 25 | 25 | 25 | 25 | 25 | 25 |

* Towing capacity is limited by GCWR; your vehicle's towing capacity is the difference between the GCWR and the actual vehicle weight, including all water, fuel, passengers and cargo. Your towed vehicle should be equipped with auxiliary brakes if the weight of the towed vehicle exceeds 1,000 lbs. Consult your Owner's Manual for further towing information.

** All tank capacities are estimated based upon calculations provided by the tank manufacturers and represent approximate capacities. The actual "usable capacity" may be greater or less than the estimated capacities based upon fabrication and installation of the tanks.

*** Actual filled LP capacity is 80% of listing due to safety shut-off required on tank.

The actual overall length of the recreational vehicle may differ from that indicated in the brochure due to variances in the manufacturing process and/or installed components. The actual length may be greater or less than that indicated. Due to the large variety of options and floorplan arrangements available to our customers, actual weights for each unit can differ significantly. Holiday Rambler provides a weight sticker on each unit we produce which includes that unit's tank capacities and approximate weight. Consult your local Holiday Rambler dealer for unit availability and further information. The information printed in this brochure reflects product design, fabrication, and component parts at the date of printing. The manufacturer reserves the right, at any time, to make changes in product design or material or component specifications as its sole option, without notice. This includes the substitution of components of a different brand or trade name which will result in comparable performance. All information printed in this brochure is subject to change after the date of printing. Some features shown or mentioned in this brochure are optional and may only be available in selected floorplans. Photographs may show props or decorations that are not standard equipment on Holiday Rambler models. Holiday Rambler, the Holiday Rambler logo and its design, are registered trademarks. All other products and company names are trademarks and/or registered trademarks of their respective holders. While the color of the motorhome's exterior and the interior fabrics depicted in this sales brochure are fair and reasonable depictions, the colors depicted may not be an exact match of the actual colors because of the variances in photo-processing and variances caused by inserting the photographs within the sales brochure. Due to product improvements, changes during the model year and/or transcription errors that may occur, information represented within this brochure may not be accurate at the time of your purchase. If certain information is significant to your purchasing decision, please confirm the information with your dealer prior to submitting your order. Component part and appliance manufacturers issue limited warranties covering those portions of the recreational vehicle not covered by the Limited Warranties issued by Monaco Coach Corporation. To learn which specific component parts and appliances are excluded from the Limited Warranties issued by Monaco Coach Corporation, please contact your selling dealership or Monaco Coach Corporation directly, or review the warranty packet inside the recreational vehicle.

2007 FLOORPLANS

How do you want to live? The decision is yours with Navigator's generous offering of floorplans and options. Once your mind is made up, we make your RV to your exact specifications, starting with a chassis that is built for each floorplan. So go ahead and make it your own.

■ CARPET | ■ TILE

40PBTF

Options:

- A
- B
- D
- E
- G
- H

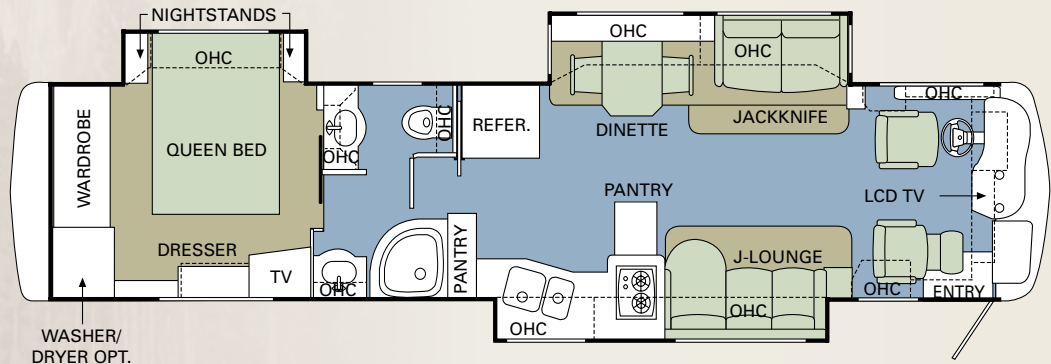

40PBQ

Options:

- A
- B
- D
- E
- G
- H

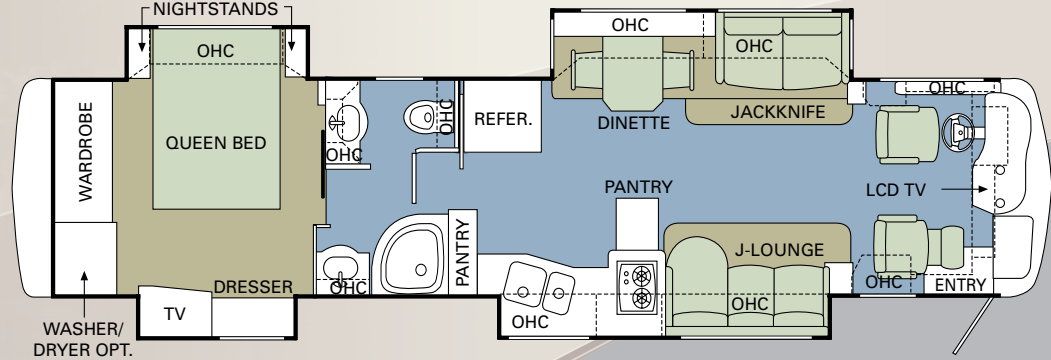

EXCLUSIVE HYDRAULIC

FULL-WALL SLIDE

✓ PANASUITE

43FST

Options:

- A
- B
- E
- G
- H
- I

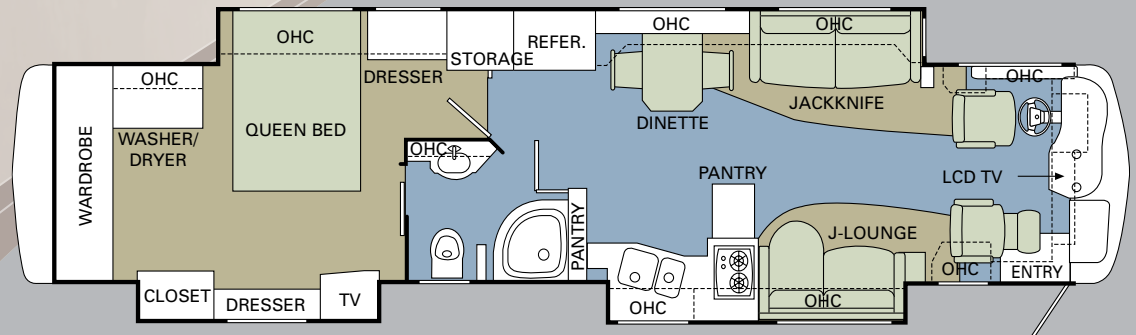

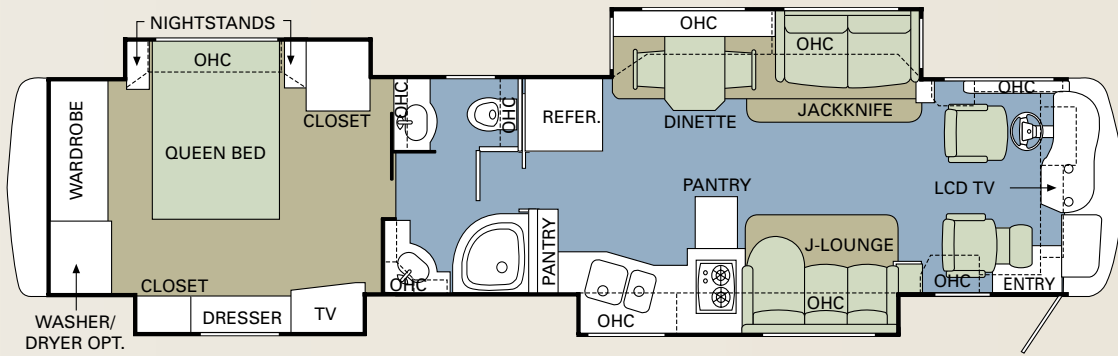

43 PBQ

- Options:
A
B
C
D
E
F
G
H
I

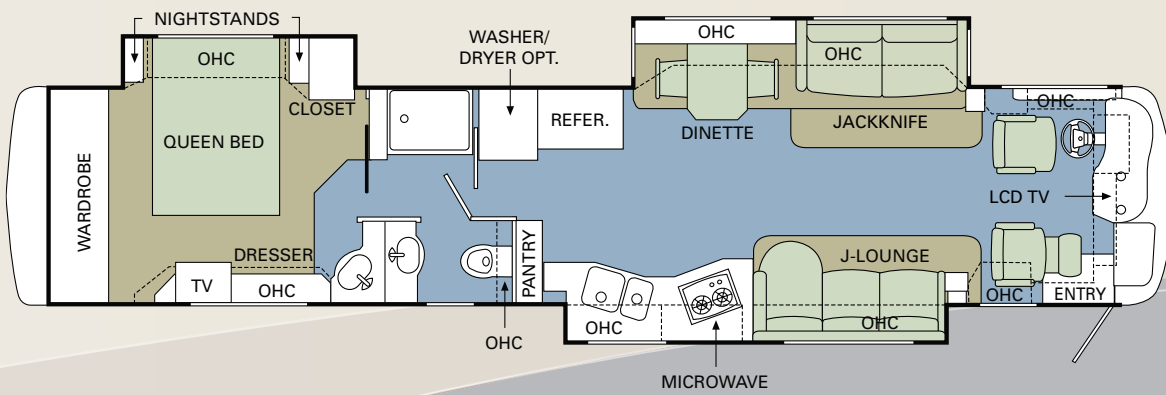

45 PBTF

- Options:
A
B
D
E
G
H
I

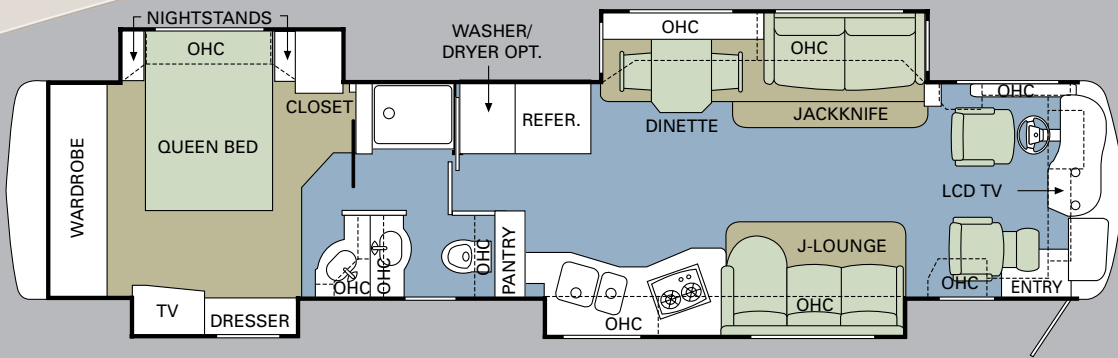

45 PBQ

- Options:
A
B
D
E
G
H
I

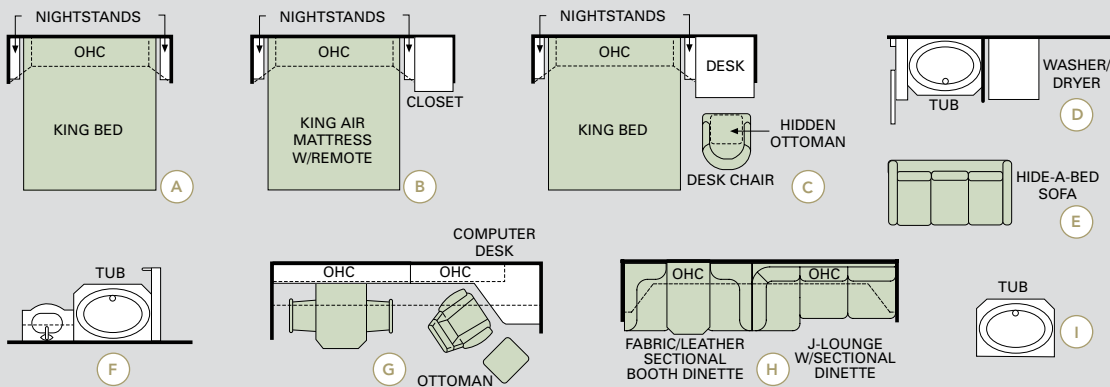

OPTIONS

 2007 NAVIGATOR®



THE POWER BEHIND THE NAME.

At Holiday Rambler, every one of our RVs shares something special – something that's hard to describe, but easy to recognize. It's that unique touch that makes Holiday Rambler stand apart. It's our complete dedication to quality at every level – from the designers who create unique looks to the craftsmen who apply the finishing touches. It's our unbeatable service, which gives you 24-hour availability, 365 days a year. It's a commitment to safety and a tradition of innovation. And finally, it's the best people in the business. The Holiday Rambler difference. It's in every RV we make – including yours.



HOLIDAY RAMBLER®
This is Living®

DEALER:

606 Nelson's Parkway Wakarusa, IN 46573
www.holidayrambler.com (800) 245-4778

24/7

ASSISTANCE
SALES • TECH • ROADSIDE



WE'RE HERE.
ANYTIME, EVERY TIME.

- Reach us anytime – literally – via our live customer support line.
- Drive in to one of our 350 Service Centers.
- Enjoy the first year free when you enroll in our Owner Advantage Roadside Assistance Program.
- See where it all begins with a tour of one of our facilities in Indiana or Oregon. Call 1-800-650-7337 or 1-800-634-0855 to find out more.

WARRANTIES

12 MONTH/24,000 MILE
basic limited warranty

5 YEAR/50,000 MILE limited
warranty on aluminum or steel
frame structure of sidewall,
roof, front and rear cap

3 YEAR/36,000 MILE limited
warranty on Roadmaster chassis

Applies to certain models. See owner's
manual for complete details.

MONACO COACH CORPORATION

Monaco is traded on the New York Stock Exchange under the listing MNC.
© 2006, Monaco Coach Corporation 6/06 NPN:BROHNAV Litho in USA.

MNC
LISTED
NYSE

