



Jayco[®]

Generations of family fun.

TOY HAULERS

2015 OCTANE AND SEISMIC BY JAYCO

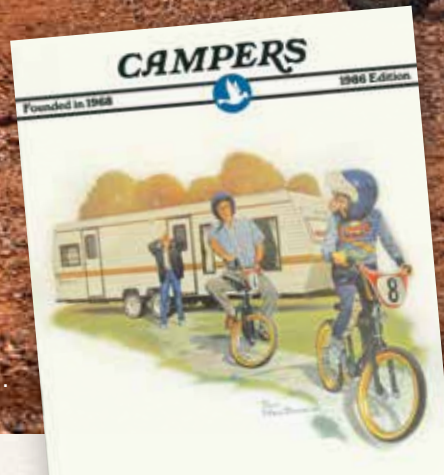

2
YEAR
WARRANTY

This 1986 brochure cover inspired our 2015 literature.

BUILT TO **open up** A WORLD OF FUN



**TRAVEL
TRAILERS**

Octane Super Lite

One of the industry's lightest toy haulers — PAGE 4

Octane

A hard-core, toy-toting travel trailer — PAGE 4

**FIFTH
WHEELS**

Seismic Wave

Our all-new, value-packed crossover — PAGE 8

Seismic

Jayco's most luxurious crossover — PAGE 10

For 45 years, Jayco has helped create generations of family fun, and over the course of that time, fun still looks remarkably the same. From campfires to fishing, from relaxing to eating, fun has the same feel generations later—and all with a Jayco RV nearby. Today, we're the largest family-owned RV manufacturer in the world, and our promise is to continually strive to build family-friendly products that will outlast just about everything but your memories. Join us in our generations of family fun.

On the cover: The 1986 brochure artwork, illustrated by Tim MacDonald, was part of a successful ad campaign. These illustrations inspired the 2015 Jayco brochure covers, which are live re-creations of Tim's artwork.



The best toys deliver the most fun, which is why the 2015 Jayco toy hauler lineup packs a radical list of amenities. For 2015, the Octane travel trailer and the Seismic fifth wheel deliver more cargo amenities than any other toy hauler, making these versatile models a toy in themselves.

OPEN FOR FUN

Ramp up your adventure with our hard-core garage, complete with 2,500-lb. rated D-rings, integrated steel backers for wheel chocks and an industry-leading, fully-insulated, vacuum-bonded 2" floor construction.

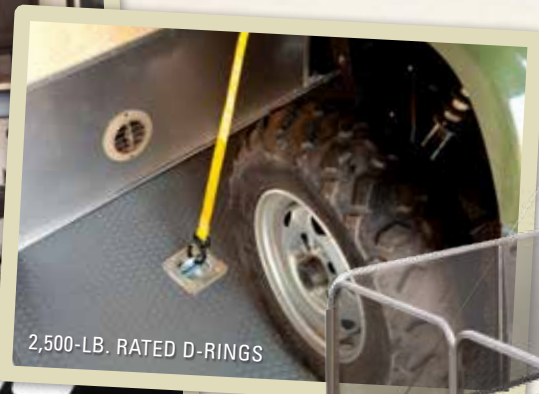

party deck [Optional — become the life of the party.]



Scan this QR code to watch how Jayco delivers Generations of Family Fun or visit www.GenerationsOfFamilyFun.com.

TRAVEL THE UNBEATEN PATH

Your toy hauler needs to be tough enough to handle whatever the road throws at it. That's where the MOR/ryde suspension system* comes in. Replacing typical steel equalizers, MOR/ryde uses rubber springs to create a smooth ride while helping isolate road shock. E-Z Lube axles and Dexter Nev-R-Adjust brakes make sure you get to where you're going — safely.

* Not available on Octane Super Lite



OCTANE T31B | STEEL

Octane

Toy-toting travel trailers

With seven floorplans and so many standard features in two of the industry's lightest toy haulers, we prefer to call the 2015 Octane a fun hauler.

RIGHT: Octane Super Lite | FAR RIGHT: Octane



OCTANE SUPER LITE 222 | METAL



OCTANE SUPER LITE 222 | METAL DÉCOR WITH OPTIONAL HERITAGE MOCHA CABINETRY



OCTANE T31B | STEEL

OCTANE INTERIOR DÉCOR CHOICES

SAHARA



METAL

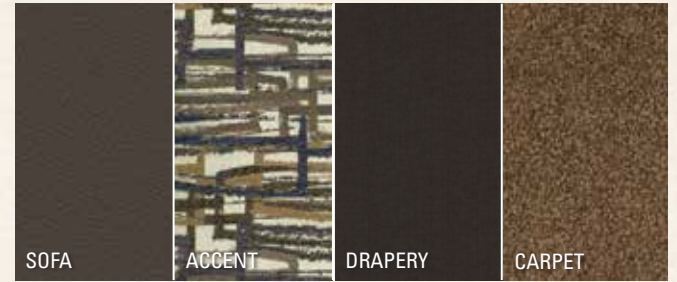

STEEL

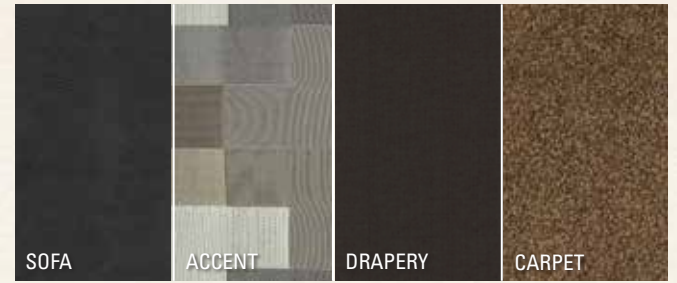

OCTANE T31B | SHOWN WITH OPTIONAL CENTER-FACING SOFAS

OCTANE SUPER LITE FLOORPLANS

OPTIONS: A, B

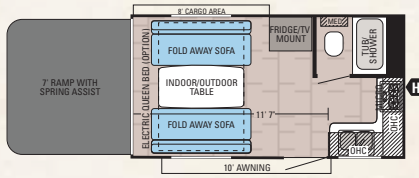

OCTANE SUPER LITE | 161

Ext. Length: 20' 7" Ext. Height: 134" Unloaded Wt. (lbs.): 3,815 Sleeps: 2-4

OPTIONS: A, B

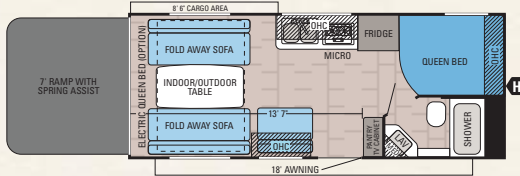

OCTANE SUPER LITE | 222

Ext. Length: 26' 4" Ext. Height: 133" Unloaded Wt. (lbs.): 4,795 Sleeps: 3-6

OPTIONS: A, B

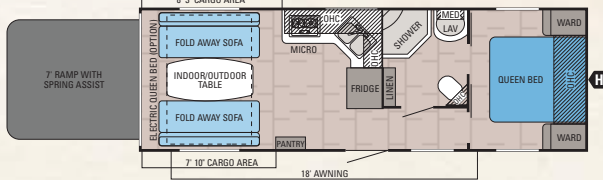

OCTANE SUPER LITE | 273

Ext. Length: 30' 10" Ext. Height: 141" Unloaded Wt. (lbs.): 5,710 Sleeps: 3-6

OPTION: A

OPTION: B

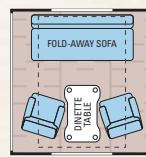

CHAIRS IN LIEU OF DOORSIDE SOFA OPTION

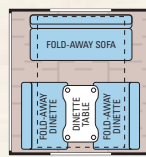

FOLD-AWAY DINETTE IN LIEU OF DOORSIDE SOFA OPTION

OCTANE SPECIFICATIONS

MODELS		DIMENSIONS				WEIGHTS (LBS.)				TANKS (GALS.)		
MODEL	FLOORPLAN	EXTERIOR TRAVEL LENGTH	EXTERIOR WIDTH	EXT. HEIGHT (WITH A/C)	INTERIOR HEIGHT	UNLOADED VEHICLE WEIGHT *	DRY HITCH WEIGHT	GROSS VEHICLE WEIGHT RATING	CARGO CARRYING CAPACITY	FRESH (INCLUDES WATER HEATER)	GRAY	BLACK
OCTANE SUPER LITE	161	20' 7"	102"	134"	89"	3,815	572	7,000	3,185	59	28	45
	222	26' 4"	102"	133"	89"	4,795	690	8,000	3,205	56	45	45
	273	30' 10"	102"	141"	89"	5,710	930	9,950	4,240	59	45	45
OCTANE	T26Y	30' 7"	102"	147"	99"	6,220	870	10,900	4,680	102	45	45
	T31B	33' 7"	102"	149"	94"	6,805	1,075	11,950	5,145	102	45	45
	T32C	34' 11"	102"	150"	94"	8,130	1,410	12,250	4,120	102	45	45
	T32E	35' 3"	102"	149"	94"	7,935	1,345	12,250	4,315	102	45	45

* The weights of certain options and/or option packages are not included in the UUV listed in the specification charts.

Unloaded Vehicle Weight (UUV): Sometimes referred to as "Dry Weight," UUV means the typical weight of this trailer as built at the factory. The UUV, as used in product literature and other promotional materials, does not include cargo, fresh water, propane, options or dealer-installed accessories

Gross Vehicle Weight Rating (GVWR): GVWR means the maximum permissible weight of the trailer, including the UUV plus passengers, personal items, all cargo, fluids, options, and dealer-installed accessories. The GVWR is equal to or greater than the sum of the UUV and the CCC.

Cargo Carrying Capacity (CCC): CCC means the maximum weight of all passengers, personal items, food, fresh water, propane, tools, other cargo and dealer-installed accessories that can be carried by the trailer. CCC is equal to or less than GVWR minus UUV. The addition of options will decrease the CCC.

Hitch Weight (HW): The hitch weight, as used in product literature and other promotional materials, does not include cargo, fresh water, propane gas, options or dealer-installed accessories. The addition of these types of items will either add to or subtract from the stated hitch weight.

It is important for your safety and enjoyment that your tow vehicle be adequately sized and equipped to tow and handle the GVWR of the RV you select. Review weights and rating of your tow vehicle and consult a competent advisor for questions or advice. Whether you are new to RVing or a veteran, get a feel for the performance of your tow vehicle before heading out on the roadways. When you tow an RV, you must drive differently than when you drive a single vehicle. Practice hooking up, driving, backing up and braking in a safe environment or seek out professional instruction. Jayco affixes a weight label to each RV which lists weight information for that vehicle. See specifications chart above.

OCTANE FLOORPLANS

OPTIONS: A, B

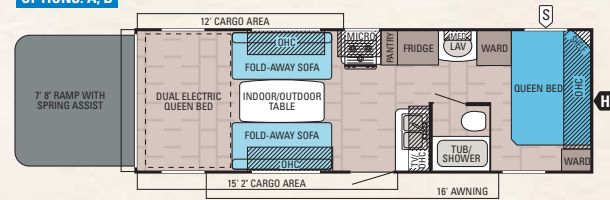

OCTANE | T26Y

Ext. Length: 30' 7" Ext. Height: 147" Unloaded Wt. (lbs.): 6,220 Sleeps: 7-8

OPTIONS: A, B

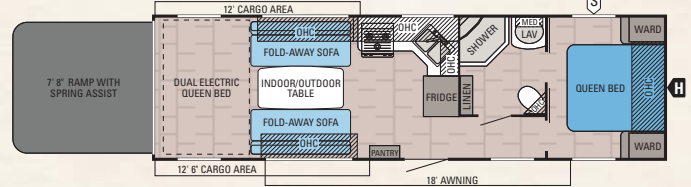

OCTANE | T31B

Ext. Length: 33' 7" Ext. Height: 149" Unloaded Wt. (lbs.): 6,805 Sleeps: 7-8

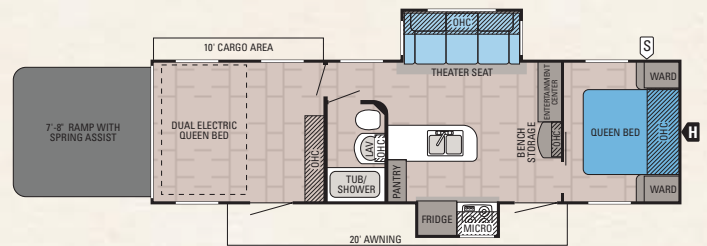

OCTANE | T32C

Ext. Length: 34' 11" Ext. Height: 150" Unloaded Wt. (lbs.): 8,130 Sleeps: 7-8

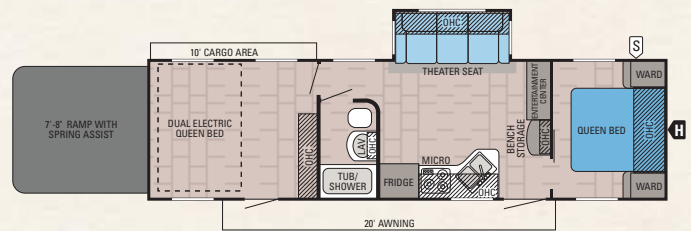

OCTANE | T32E

Ext. Length: 35' 3" Ext. Height: 149" Unloaded Wt. (lbs.): 7,935 Sleeps: 7-8

OCTANE SUPER LITE STANDARDS & OPTIONS

STANDARD EXTERIOR EQUIPMENT

.024 mesa crimp exterior aluminum
Fiberglass, radius-profile front wall
2", unitized, laminated floor with welded, tubular aluminum frame and block-foam insulation
102"-wide-body construction
I-Class cambered structural-steel I-beams
Magnum Truss Roof System
G20 dark-tinted, safety-glass windows
Marine-grade exterior speakers (2)
Nitrogen-filled radial tires
E-Z Lube axles
Dexter Nev-R-Adjust brakes
Spare tire and carrier
RVQ grill hook-up
Diamond-plated panel on front
30-amp power service
Double 20-lb. propane bottles with regulator
Battery tray on A-frame
Systems monitor panel
Outside shower
Black tank flush
Water heater bypass system
Water system winterization kit
LED taillights

STANDARD INTERIOR EQUIPMENT

Espresso wood cabinetry
Ball bearing drawer guides, 75-lb. capacity with full-drawer extension
Stainless-steel appliances
2-burner range
Deep double-bowl sink with cutting board cover (1)
Auto-ignition furnace with wall thermostat
Indoor/outdoor dinette table
Command center (select models)
USB charging port
Crank-up digital TV antenna with signal booster
Vinyl flooring throughout
Pleated night shades
ABS tub/shower surround
Glass shower door (select models)
Marine toilet with foot flush

Air conditioner ducts in front bedroom (select models)
Under-bed storage with gas struts (select models)
Fold-away sleeper/sofas (2)

STANDARD RAMP & CARGO EQUIPMENT

Radius-cornered ramp door, 2,500-lb. capacity, 96" wide ramp door opening
High-intensity rear ramp lights (2)
Bar-lock latches and keyed ramp door locks
Flush floor-mounted tie-down rings anchored to frame, 2,500-lb. capacity each
Garage vent ports

CUSTOMER VALUE PACKAGE

Aluminum rims
Stabilizer jacks (4)
Patio awning with adjustable pitch
18-gal./hr. quick-recover gas/electric DSI water heater
13,500-BTU air conditioner with wall thermostat
6 cu. ft. refrigerator
Convection microwave
Sony Xplod AM/FM/CD stereo system with two speakers
Bathroom power vent

OPTIONS

Customer Value Package with 15,000-BTU A/C
Enclosed underbelly
Electric patio awning with adjustable pitch
3,500-lb. electric tongue jack
Heritage Mocha raised-panel cabinet doors (in lieu of Espresso)
Fuel station with 24-gal. tank
Self-contained 3,500-watt generator
Retractable screen wall
Removable carpet in cargo area
Fold-away dinette in lieu of doormside sofa
Free-standing table with two black chairs in lieu of doormside sofa (n/a with Sahara décor option)
Power bed in cargo bay
Sony Xplod subwoofer and amplifier

OCTANE STANDARDS & OPTIONS

STANDARD EXTERIOR EQUIPMENT

Laminated fiberglass sidewalls
2", unitized, laminated floor with welded, tubular aluminum frame and block-foam insulation
102"-wide-body construction
I-Class cambered structural-steel I-beams
Magnum Truss Roof System
G20 dark-tinted, safety-glass windows
Sony marine-grade exterior speakers (2)
MOR/ryde CRE 3000 rubber axle equalizer
Nitrogen-filled radial tires
E-Z Lube axles
Dexter Nev-R-Adjust brakes
Spare tire and carrier
RVQ grill hook-up
Triple-tread entrance step
Lockable baggage doors, insulated and radius-cornered
Diamond-plated panel on front
30-amp power service
Cable and satellite TV prepped
Double 30-lb. propane bottles with regulator
Generator prep with 19-gal. fuel tank
Double battery tray on A-frame
Systems monitor panel
Outside shower
Black tank flush
Water heater bypass system
Water system winterization kit
LED taillights

STANDARD INTERIOR EQUIPMENT

Espresso wood cabinetry
Ball bearing drawer guides, 75-lb. capacity with full-drawer extension
Stainless-steel appliances
3-burner range with 9,000-BTU SuperBurner and piezo igniter
Deep double-bowl sink with cutting board cover (1)
Auto-ignition furnace with wall thermostat
Indoor/outdoor dinette table
Command center
USB charging port
Crank-up digital TV antenna with signal booster
Vinyl flooring throughout
Pleated night shades throughout
ABS tub/shower surround
Glass shower door (select models)
Marine toilet with foot flush
Air conditioner ducts in front bedroom (select models)
Under-bed storage with gas struts (select models)
Fold-away sleeper/sofas (2) (select models)

STANDARD RAMP & CARGO EQUIPMENT

Radius-cornered ramp door, 2,500-lb. capacity, 96" wide ramp door opening
High-intensity rear ramp lights (2)
Bar-lock latches and keyed locks on ramp door
Flush floor-mounted tie-down rings anchored to frame, 2,500-lb. capacity each
Welded-steel floor storage compartment
Garage vent ports
Overhead storage cabinets
Dual retractable electric queen bunk beds
Retractable screen wall

CUSTOMER VALUE PACKAGE

Stabilizer jacks (4)
Electric patio awning with adjustable pitch
Transition ramp
3,500-lb. electric tongue jack
Fuel station with 24-gal. tank
18-gal./hr. quick-recover gas/electric DSI water heater
13,500-BTU air conditioner with wall thermostat
8 cu. ft. double-door refrigerator
Convection microwave
Bi-fold range cover
Sony Xplod AM/FM/CD stereo system with four speakers, subwoofer and amplifier
Bathroom power vent
Skylight in tub/shower

OPTIONS

Customer Value Package with 15,000-BTU A/C
Enclosed underbelly
Heritage Mocha raised-panel cabinet doors (in lieu of Espresso)
32" LED TV
4,000-watt generator with auto-changeover switch
ToyLok retractable security cable
Removable carpet in cargo area
Party Deck with folding rails
Fold-away dinette in lieu of doormside sofa (select models)
Free-standing table with two black chairs in lieu of doormside sofa (select models) (n/a with Sahara décor option)
Front-to-rear flip sofas in lieu of bottom rear electric queen bunk bed (n/a with Party Deck option)
Center-facing flip sofas in lieu of bottom rear electric queen bed



AN AMPED-UP STEREO SYSTEM

We didn't toy around with Octane's entertainment features, packing a Sony Xplod stereo system, four speakers (two on Octane Super Lite), a subwoofer and an amplifier into our Customer Value Package. (The subwoofer and amplifier are optional on Octane Super Lite.)



SEISMIC WAVE 320W | FOIL

Seismic Wave

The value-packed crossover

Pack the toys without breaking the bank. The all-new Seismic Wave answers demand for a value-packed yet feature-filled crossover. Our newest addition boasts an impressive list of features, like theater seats,* solid-surface countertops* and MCD roller night shades.



SEISMIC WAVE 320W | FOIL



SEISMIC WAVE 320W | FOIL

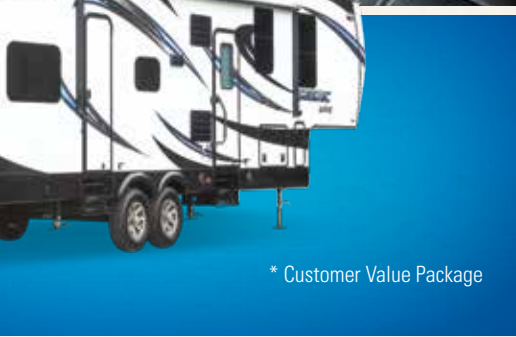

* Customer Value Package



LEFT: SOUND SYSTEM SOUND BAR
RIGHT: CUSTOMER VALUE PACKAGE THEATER SEATING

SEISMIC WAVE STANDARDS AND OPTIONS

STANDARD EXTERIOR EQUIPMENT

High-gloss fiberglass sidewalls
 Fiberglass front cap with Jayco logo
 3/8" roof decking on 5" crowned wood truss rafters (R-30)
 5/8" tongue-and-groove plywood main floor decking
 10" I-Class cambered structural-steel I-beams
 Heat reflective foil insulation in living area, bedroom, slideout floors
 One-piece seamless roof membrane
 Climate Shield insulation package (see package details)
 Magnum Truss Roof System
 MOR/ryde CRE 3000 rubber axle equalizer
 16" nitrogen-filled radial tires
 E-Z Lube axles
 Dexter Nev-R-Adjust brakes
 30" x 72" radius-cornered entrance door with step light
 G20-tinted, automotive, frameless windows
 Metal slam-latch lockable baggage doors, insulated and radius-cornered
 Exterior TV hook-up in basement area
 Marine-grade Sony exterior speakers (2)
 Heated, enclosed outside utility center
 Double 30-lb. propane bottles
 Triple battery compartment and disconnect switch for 3 batteries
 Generator prep with 27-gal. fuel tank
 24-gal. fuel station with command center gauge
 146-gal. fresh water capacity
 Black holding tank sprayer and sewer hose compartment
 Water system winterization kit
 Outside shower
 LED taillights

STANDARD INTERIOR EQUIPMENT

Residential-style, pre-drilled and screwed Amish-crafted cabinet construction with hidden hinges
 Ball bearing drawer guides, 75-lb. capacity
 3-burner stainless-steel range-top with 9,000-BTU SuperBurner and piezo igniter
 Oversized 21" oven
 Under-mounted, stainless-steel sink and sink covers (2)
 Water heater bypass system
 Water purification system
 USB charging port in kitchen
 Premium sound system with Blu-ray disc player, sound bar and Bluetooth
 40,000-BTU furnace, auto-ignition and black digital thermostat
 Shower with surround
 Denver Mattress Advanced queen-sized (60" x 80") pillowtop mattress
 Gas-strut, under-bed storage
 Walk-in closet with triple-sliding mirrors (select models)
 MCD blackout roller shades in living room
 TV prep in bedroom
 Bedroom wired and framed for second 15,000-BTU air conditioner

STANDARD RAMP AND CARGO EQUIPMENT

Vacuum-bonded, laminated, 2" garage floor, fully insulated with block foam
 Hinged spring-assist, radius-cornered ramp door, 2,500-lb. capacity, 93 3/8"-wide opening with anti-slip, non-skid flooring
 High-intensity, flush-mounted ramp lights (2)
 12"-wide tread plate splash guard
 Tuff-ply, rubberized garage floor liner
 Flush floor-mounted tie-down rings, anchored to frame, 2,500-lb. capacity each
 Steel backers in floor for wheel chocks
 24" x 72" garage door with step light
 Patio door with screen (select models)
 Black pull-down retractable screen wall/privacy curtain
 Vinyl snap-on window coverings
 Power queen beds with convertible sofas
 Washer/dryer prep
 Cargo bay wired and framed for 15,000-BTU air conditioner
 Vent ports, tinted power roof vent and closeable, directional air conditioner ducts
 Sony Mechless stereo with built-in Bluetooth

CUSTOMER VALUE PACKAGE (MANDATORY)

Heated, insulated and enclosed holding tanks
 Aluminum rims
 Spare tire with carrier
 Folding roof ladder
 Electric awning
 Security lights (2)
 Bi-fold range cover
 Solid-surface kitchen countertops
 20-gal./hr. quick-recovery gas/electric auto-ignition water heater
 Whisper Quiet 15,000-BTU air conditioner
 TV entertainment system with 40" TV
 Theater seating
 Bath skylight
 Bathroom power vent

OPTIONS

Customer Value Package with 15,000-BTU A/C and heat pump
 Dual-pane, frameless, tinted, safety-glass windows
 5,500-watt generator with auto changeover switch
 MOR/ryde pin box
 6-point electric automatic-leveling system
 Party deck with folding rails and awning
 2nd 12V electric awning with LED lights (select models)
 Convection microwave with oven in lieu of cooktop and drawers
 32" LED HDTV in bedroom
 2nd 15,000-BTU air conditioner in bedroom
 15,000-BTU air conditioner in cargo area
 Removable carpet in cargo area



SEISMIC 3914 | SADDLE

Seismic

The luxury crossover

The 2015 Jayco Seismic is more than just a toy hauler. It's a luxury fifth wheel. Comfort seekers will enjoy solid-surface counters and a heart-pounding entertainment system, while toy enthusiasts will love the 6-point leveling system that packs a 30,000-lb. lifting capacity.



SEISMIC 3902 | STEEL



SEISMIC 3902 | STEEL



LEFT: MCD BLACKOUT ROLLER SHADES
RIGHT: FULL-FEATURED BATHROOMS

SEISMIC STANDARDS AND OPTIONS

STANDARD EXTERIOR EQUIPMENT

High-gloss fiberglass sidewalls
 Fiberglass front cap with Jayco logo
 Integrated LED front cap docking light
 3/8" roof decking on 5" crowned wood truss rafters (R-30)
 5/8" tongue-and-groove plywood main floor decking
 12" I-Class cambered structural-steel I-beams
 Heat reflective foil insulation in living area, bedroom, slideout floors and pass-thru storage compartment
 One-piece seamless roof membrane
 Climate Shield insulation package (see package details)
 Magnum Truss Roof System
 Wide-stance landing gear
 6-point automatic-leveling system
 MOR/ryde pin box
 MOR/ryde CRE 3000 rubber axle equalizer
 16" nitrogen-filled radial tires
 E-Z Lube axles
 Dexter Nev-R-Adjust brakes
 30" x 72" radius-cornered entrance door with LED step light, oversized window and keyless entry
 Second 12V electric awning
 Hand-held remote for awning, slideouts and patio lights
 G20-tinted, automotive, frameless windows
 Stor-Galore basement storage
 Metal slam-latch lockable baggage doors, insulated and radius-cornered
 Exterior TV hook-up in basement area
 Marine-grade exterior Sony speakers (2)
 Heated, enclosed Uni-Dock utility center
 5,500-watt generator with auto-changeover switch
 Triple 30-lb. propane bottles with regulator and slide tray
 Triple battery compartment and disconnect switch for 3 batteries
 24-gal. fuel station with command center gauge
 148-gal. fresh water capacity
 Black holding tank sprayer and sewer hose compartment
 Water system winterization kit
 Outside shower
 LED taillights

STANDARD INTERIOR EQUIPMENT

Residential-style, pre-drilled and screwed Amish-crafted cabinet construction with hidden hinges
 Ball bearing drawer guides, 75-lb. capacity
 Stainless-steel appliances
 3-burner, stainless-steel range-top with 9,000-BTU SuperBurner and piezo igniter
 30" residential-style stainless-steel microwave oven
 Oversized 21" oven
 High-gloss, solid-surface countertops with under-mounted stainless-steel sink and sink covers (2)
 Toe-kick kitchen accent lighting
 LED recessed lighting package
 Water heater bypass system
 Water purification system
 USB charging port in kitchen
 Premium sound system with Blu-ray disc player, sound bar and Bluetooth
 Theater seating
 40,000-BTU furnace, auto-ignition and black digital thermostat
 Radius shower with colored surround

Denver Mattress Advanced queen-sized (60" x 80") pillowtop mattress
 Gas-strut, under-bed storage
 Walk-in closet with triple-sliding mirrors (select models)
 MCD blackout roller shades in main living area
 32" LED HDTV/ cable jacks in bedroom
 Bedroom wired and framed for second air conditioner

STANDARD RAMP AND CARGO EQUIPMENT

Vacuum-bonded, laminated, 2" garage floor, fully insulated with block foam
 Hinged spring-assist, radius-cornered ramp door, 2,500-lb. capacity, 93 3/8"-wide opening with anti-slip, non-skid flooring
 High-intensity, flush-mounted ramp lights (2)
 18"-wide tread plate splash guard
 Tuff-ply, rubberized garage floor liner
 Welded steel, beaver-tail storage in garage floor
 Flush floor-mounted tie-down rings, anchored to frame, 2,500-lb. capacity each
 Steel backers in floor area for wheel chocks
 30" x 72" garage door with LED step light
 Patio door with screen (select models)
 Premium coach/cargo passage door with window and LED light strip (select models)
 Black retractable screen wall/privacy curtain
 Vinyl snap-on window covering
 Power queen beds with convertible sofas
 Touchscreen entertainment system with DVD and Bluetooth
 Washer/dryer prep
 Cargo bay wired and framed for air conditioner
 Vent ports, tinted power roof vent and closeable, directional air conditioner ducts

CUSTOMER VALUE PACKAGE (MANDATORY)

Heated, insulated and enclosed holding tanks
 Aluminum rims
 16" spare tire with carrier
 Folding roof ladder
 Electric patio awning
 Security lights (2)
 12-gal. gas/electric auto-ignition water heater
 Whisper Quiet 15,000-BTU air conditioner
 Home theatre system with 50" HDTV
 Bath skylight
 Bathroom power vent

OPTIONS

Customer Value Package with 15,000-BTU A/C and heat pump
 Premium Paint Package
 Dual-pane, frameless, tinted, safety-glass windows
 Party Deck with folding rails, electric awning and remote control
 Slideout awnings (2)
 Slideout awnings (3)
 Convection microwave with oven in lieu of cooktop and drawers
 12 cu. ft. refrigerator
 Fireplace (3902)
 Swivel chair (1) in cargo area
 Swivel chairs (2) in cargo area
 Dyson vacuum
 2nd 15,000-BTU air conditioner in bedroom
 15,000-BTU air conditioner in cargo area
 Forward- and rear-facing sofa beds
 Removable carpet in cargo area

SEISMIC WAVE FLOORPLANS

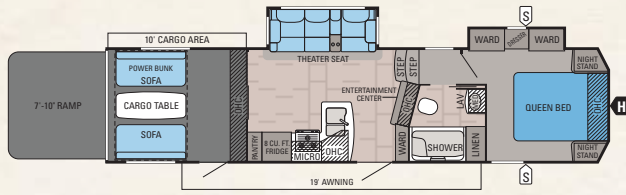

SEISMIC WAVE | 310W

Ext. Lgth: 36' 5" Ext. Ht: 162" Unloaded Wt (lbs.): 11,215 Sleeps: 6

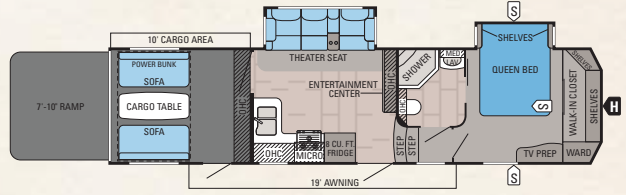

SEISMIC WAVE | 320W

Ext. Lgth: 35' 5" Ext. Ht: 162" Unloaded Wt (lbs.): 10,975 Sleeps: 6

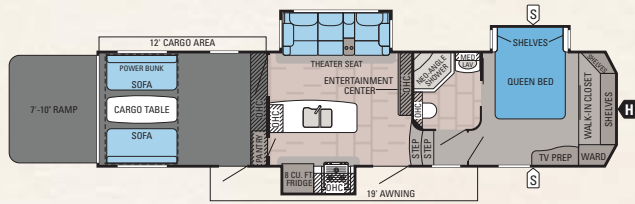

SEISMIC WAVE | 352W

Ext. Lgth: 37' 4" Ext. Ht: 162" Unloaded Wt (lbs.): 11,435 Sleeps: 6

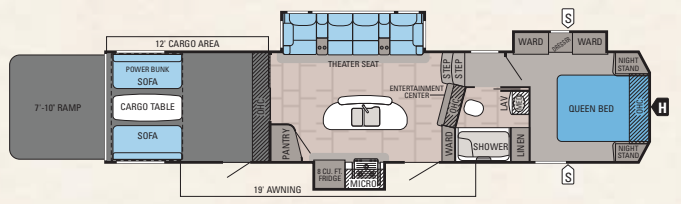

SEISMIC WAVE | 362W

Ext. Lgth: TBD Ext. Ht: TBD Unloaded Wt (lbs.): TBD Sleeps: 6

SEISMIC FLOORPLANS

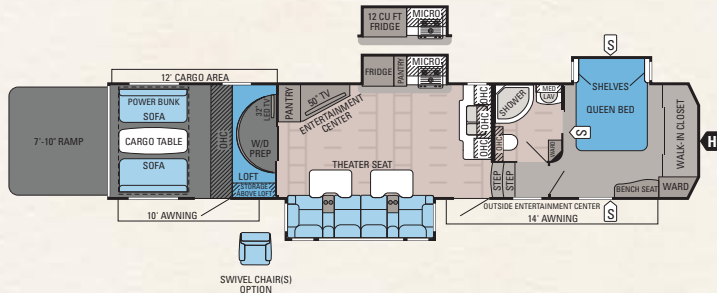

SEISMIC FULL-PROFILE | 3902

Ext. Lgth: 42' 2" Ext. Ht: 159" Unloaded Wt (lbs.): 14,065 Sleeps: 7

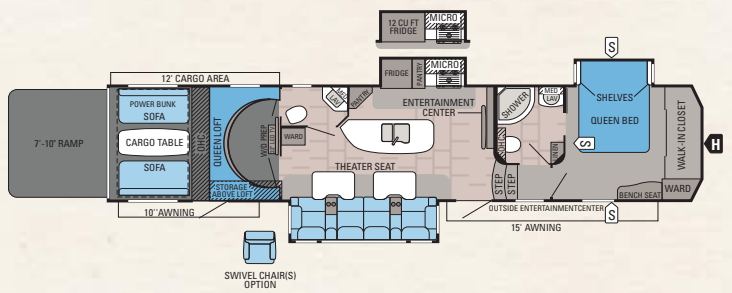

SEISMIC FULL-PROFILE | 3912

Ext. Lgth: 42' 7" Ext. Ht: 160" Unloaded Wt (lbs.): 14,480 Sleeps: 8

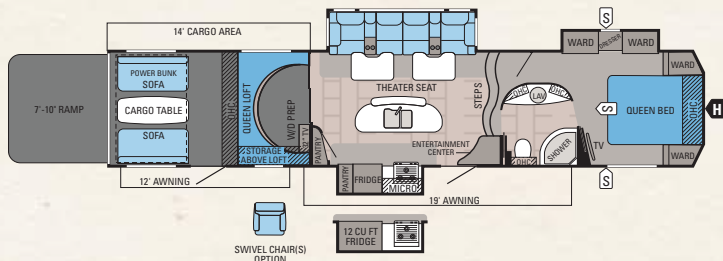

SEISMIC FULL-PROFILE | 3914

Ext. Lgth: 42' 10" Ext. Ht: 159" Unloaded Wt (lbs.): 14,200 Sleeps: 8

SEISMIC WAVE SPECIFICATIONS

MODELS		DIMENSIONS				WEIGHTS (LBS.)				TANKS (GALS.)		
FLOORPLAN	EXTERIOR TRAVEL LENGTH*	EXTERIOR WIDTH	EXT. HEIGHT (WITH A/C)	EXT. HEIGHT (WITH OPT. BEDROOM A/C)	INTERIOR HEIGHT	UNLOADED VEHICLE WEIGHT**	DRY HITCH WEIGHT	GROSS VEHICLE WEIGHT RATING	CARGO CARRYING CAPACITY	FRESH (INCLUDES WATER HEATER)	GRAY	BLACK
310W	36' 5"	102"	162"	162"	103"	11,215	2,480	15,750	4,535	146	87	50
320W	35' 5"	102"	162"	162"	103"	10,975	2,270	15,500	4,525	146	87	50
352W	37' 4"	102"	162"	162"	103"	11,435	2,570	15,950	4,515	146	87	50
362W	TBD	102"	TBD	TBD	103"	TBD	TBD	TBD	TBD	TBD	TBD	TBD

SEISMIC SPECIFICATIONS

MODELS		DIMENSIONS				WEIGHTS (LBS.)				TANKS (GALS.)		
FLOORPLAN	EXTERIOR TRAVEL LENGTH*	EXTERIOR WIDTH	EXT. HEIGHT (WITH A/C)	EXT. HEIGHT (WITH OPT. BEDROOM A/C)	INTERIOR HEIGHT	UNLOADED VEHICLE WEIGHT**	DRY HITCH WEIGHT	GROSS VEHICLE WEIGHT RATING	CARGO CARRYING CAPACITY	FRESH (INCLUDES WATER HEATER)	GRAY	BLACK
3902	42' 2"	102"	159"	159"	103"	14,065	3,185	19,000	4,935	148	122.5	50
3912	42' 7"	102"	160"	160"	103"	14,480	3,160	19,000	4,520	148	122.5	82.6
3914	42' 10"	102"	159"	159"	103"	14,200	3,270	19,000	4,800	148	87	50

*Distance from the pin box to the bumper; total exterior length may be longer. **The weights of certain options and/or option packages are not included in the UVW listed above.

Unloaded Vehicle Weight (UVW): Sometimes referred to as "Dry Weight," UVW means the typical weight of this trailer as built at the factory. The UVW, as used in product literature and other promotional materials, does not include cargo, fresh water, propane, options or dealer-installed accessories.

Gross Vehicle Weight Rating (GVWR): GVWR means the maximum permissible weight of the trailer, including the UVW plus passengers, personal items, all cargo, fluids, options, and dealer-installed accessories. The GVWR is equal to or greater than the sum of the UVW and the CCC.

Cargo Carrying Capacity (CCC): CCC means the maximum weight of all passengers, personal items, food, fresh water, propane, tools, other cargo and dealer-installed accessories that can be carried by the trailer. CCC is equal to or less than GVWR minus UVW. The addition of options will decrease the CCC.

Hitch Weight (HW): The hitch weight, as used in product literature and other promotional materials, does not include cargo, fresh water, propane gas, options or dealer-installed accessories. The addition of these types of items will either add to or subtract from the stated hitch weight.

It is important for your safety and enjoyment that your tow vehicle be adequately sized and equipped to tow and handle the GVWR of the RV you select. Review weights and rating of your tow vehicle and consult a competent advisor for questions or advice. Whether you are new to RVing or a veteran, get a feel for the performance of your tow vehicle before heading out on the roadways. When you tow an RV, you must drive differently than when you drive a single vehicle. Practice hooking up, driving, backing up and braking in a safe environment or seek out professional instruction. Jayco affixes a weight label to each RV which lists weight information for that vehicle. See specifications chart above.

SEISMIC WAVE AND SEISMIC INTERIOR DÉCOR CHOICES

FOIL



SADDLE



STEEL



SEISMIC EXTERIOR CHOICES



STANDARD GRAPHICS PACKAGE OPTIONAL PREMIUM PAINT PACKAGE

WE START WITH ONE OF THE INDUSTRY'S **strongest** foundations



Full-width outriggers: We build on full-width outriggers that are spaced 4-6 feet apart (vs. 8 ft.) to better support the weight of the wall.

4-6 ft.

Jayco builds on custom-sized frames, designed specifically for each floorplan. Other manufacturers use stock frames, modifying and welding the frame to fit.

I-Class cambered structural-steel I-beams: Jayco uses a unique molded, one-piece design to prevent unit from twisting; competing three-piece I-beams can warp over time at the welded seams.

– so that we can build the industry's most reliable RV



CLIMATE SHIELD

Extend your camping season

with the Jayco Climate Shield, featured on Seismic. Designed for efficient heating and cooling, Climate Shield protects against extreme heat and extreme freezing — even when temperatures hit a high of 100° F or a low of 0° F.



LIVING ROOM	KITCHEN	BATHROOM	HOLDING TANK	BEDROOM
0°F 70°	0°F 69°	0°F 71°	0°F 60°	0°F 71°
100°F 69°	100°F 70°	100°F 68°	100°F 72°	100°F 71°

UNIT AREA

- All vertical walls
- Behind front cap
- Roof
- Main floor
- Slide floor
- Bedroom floor
- Inside open pin box
- Enclosed drop-frame overhang

TYPE OF INSULATION

- Block foam
- Fiberglass insulation
- Fiberglass insulation + foil
- Fiberglass insulation + foil
- Foil
- Fiberglass insulation + foil
- Foil
- Foil

FIFTH WHEEL CONSTRUCTION

extra measures for extra warmth

- 1 In the upper area of the fifth wheel floorplan, Jayco uses a double layer of fiberglass insulation behind the front cap, along with Flexfoil and fiberglass insulation in the floor, to provide extra warmth where it's needed most — in the bedroom.
- 2 Jayco's aerodynamic front cap is engineered to withstand the rigors of the road. This gel-coated fiberglass cap features more support with 1/4" plywood bracing, not typically found on other fifth wheels.

* Seismic was tested in 0° F and 100° F weather over an extended period of time in a controlled environment and all functions of the coach were fully operational. Testing cannot account for natural elements, such as wind or moisture. In actual use, unit may not perform as tested. In addition, outside components are subject to freezing and require steps to properly insulate. Jayco's warranty does not cover damage caused by freezing.

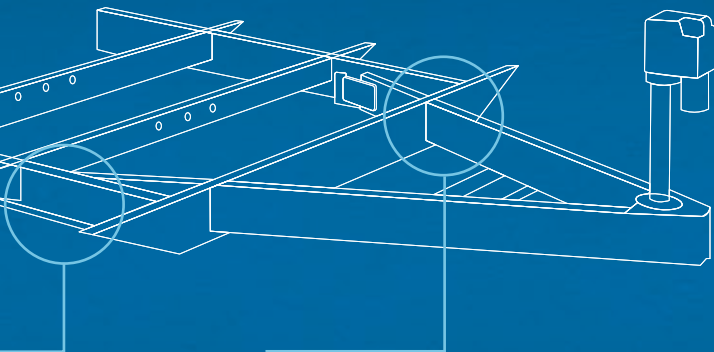

Octane travel trailer integrated A-frame: The A-frame runs through the main frame, preventing the hitch from buckling like competing tack-welded frames.

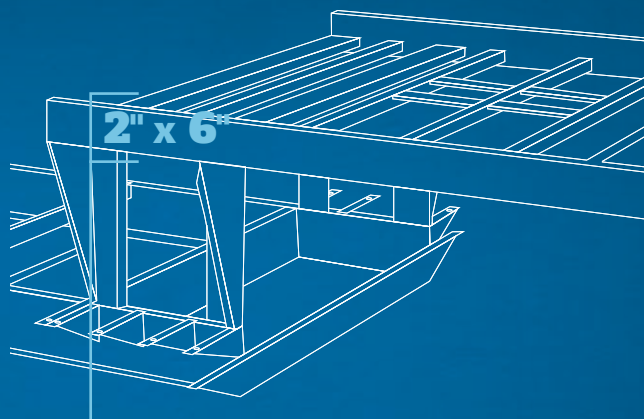

Seismic fifth wheel frame: The frame over the truck bed is built on superior 2" x 6" tube perimeter structure to better support the bedroom sidewalls. Some fifth wheels have a smaller frame, and these manufacturers may add a sidewall support seam to compensate for expansion joints.



THE MAGNUM TRUSS ROOF SYSTEM 50 percent stronger

In a side-by-side comparison test, Jayco's exclusive Magnum Truss Roof System withstood 4,500 lbs. — 50 percent more than other roofs. The difference?

- 3 Jayco uses 5" crowned wood trusses (4 1/2" on Octane), solid-wood studs and oversized nail plates to maximize the roof's load capacity.
- 4 Then, we screw down 3/8" roof decking at every seam, a process that is more durable than stapled construction.
- 5 Finally, our one-piece, sidewall-wrapped DiFlex II material provides the ultimate in leak protection.

WALL CONSTRUCTION

vacuum-bonded walls

- 6 Using 144 tons of pressure for 16-18 minutes, Octane and Seismic feature durable, vacuum-bonded walls, while smooth, high-gloss fiberglass exteriors provide long-lasting appeal (n/a Octane Super Lite).
- 7 Welded aluminum framing gives our toy haulers a durable, lightweight structure.

GARAGE CONSTRUCTION

fortified for your toys

- 8 Octane and Seismic are among only a few toy haulers in the industry with vacuum-bonded, block foam-insulated, 2" garage floors, delivering added durability for your heavy toys.
- 9 D-rings, rated for 2,500 lbs., are mounted through the vacuum-bonded floor and bolted to a steel plate attached to the frame. Some manufacturers don't add this extra reinforcement.

2
YEAR
WARRANTY



Jayco[®]

Generations of family fun.

Bumper-to-front limited warranty*

FAMILY **fun** starts with peace of mind

At Jayco, we build our RVs to handle every adventure, then we back our products with an industry-leading 2-year limited warranty. You won't find a better warranty in the business because the only strings we attach are those that deliver the ultimate in reliability. That's the Jayco difference. So go explore. We have the warranty that will follow you anywhere.

*For a copy of our 2-year limited warranty with full terms and conditions, please contact your local Jayco dealer.

FREE Roadside Assistance

Travel worry-free with Jayco's Customer First Roadside Assistance program, yours at no cost during the first year of ownership. This program is offered through Coach-Net, the country's largest RV emergency road service, and gives you immediate access to assistance.

ecoadvantage™

Jayco's long-term commitment
to generations of family fun



Scan this QR code with your smartphone to watch a video about our efforts and the impact we're making on our planet.

ecoadvantage.jayco.com

The fun starts with your local Jayco dealer

Your local dealer

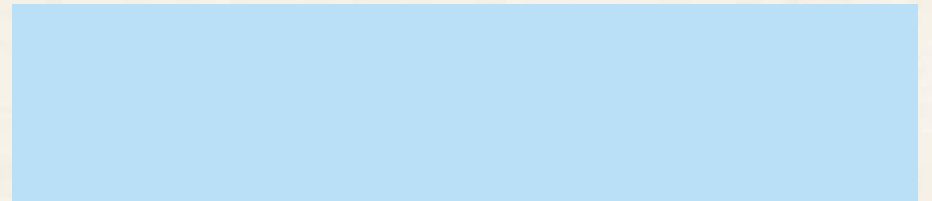

From giving advice to selling and servicing products, we consider our loyal dealers the glue in our family bond. Establishing a solid relationship with your local Jayco dealer is a key component in the enjoyment of your new Jayco. By purchasing from a local dealer, you will have a convenient location for sales, parts and service support. We hope you consider them a part of your camping family.

Follow Jayco



Jayco, Inc., P.O. Box 460, Middlebury, IN 46540, www.jayco.com © **RVIA** See dealer for further information and prices. All information in this brochure is the latest available at the time of publication approval. Jayco reserves the right to make changes and to discontinue models without notice or obligation. Photos in this brochure may show optional equipment and props for photography purposes. RVs built for sale in Canada may differ to conform to Canadian codes. ©2014 Jayco, Inc. 15-TYHL-PL 1014-80K Printed in U.S.A.