

Highland

RIDGE RV



Mesa Ridge

FIFTH WHEELS & TRAVEL TRAILERS

FIFTH WHEEL INTERIOR



MF337RLS Living Room



The Mesa Ridge line of fifth wheels is designed with the seasoned traveler in mind. You'll find floorplans designed for extended use that maximize space while keeping weight to a minimum. Wide body construction and 42" deep slides lend a sense of space that's just not achievable with lesser products. From brand name appliances to Corian counter-tops, you'll find feature content that the accomplished RV owner will appreciate. Rugged construction, top quality materials and leading edge innovation. If you're serious about the RV lifestyle, this is your fifth wheel.



Full Extension Drawers



Optional 12 cu. ft. Refrigerator



Portable Island on Castors

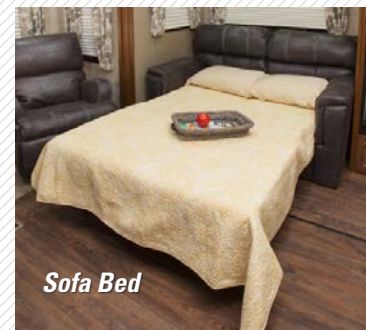

Sofa Bed



Pull-Out Pantry



MF367BHS Bunk Room



MF367BHS Bunk Room w/ Party Room Package

RELIABLE COMFORTABLE ENJOYABLE



MF337RLS Bathroom



MF337RLS Bedroom

TRAVEL TRAILER INTERIOR



MR320RES Living Room



The Mesa Ridge travel trailer by Highland Ridge RV has set the bar again with the industry's best features and amenities in a travel trailer. Whether it is the rich corian countertops, Amish crafted cabinetry, advanced electronics or 4 Seasons Package. This coach will be sure to impress even the most demanding consumer. So grab the kids or spouse and join us in experiencing the great outdoors!



Refrigerator



Pull-Out Pantry



U-Lounge



MR310BHS Bunk Room



MR320RES Kitchen



MR320RES Bathroom



MR320RES Bedroom

EXTERIOR
FIFTH WHEEL / TRAVEL TRAILER

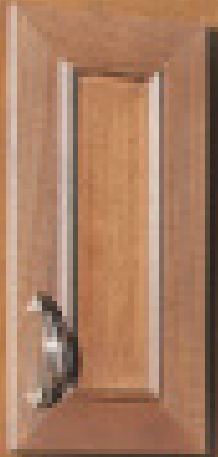

Outside Kitchen (Select Floorplans)

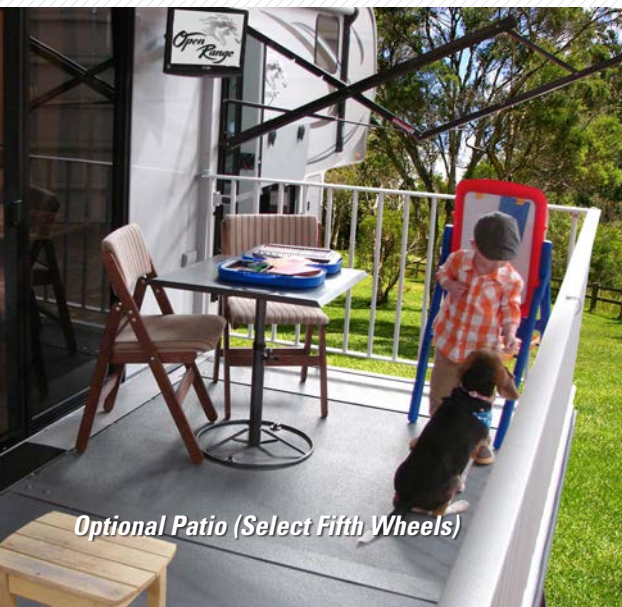

Optional Patio (Select Fifth Wheels)



200 Cu. Ft. Exterior Storage (MF346FLR & MF376FBH)



FIFTH WHEEL HIGHLIGHTS



Exterior Convenience Center



Outside Speakers



Exterior Entertainment



Propane Tanks on Slide Trays



JT Strong Arms

TRAVEL TRAILER HIGHLIGHTS



Exterior Convenience Center



Power Tongue Jack



Optional One-Piece Fiberglass Front Cap



Optional Power Stabilizer Jacks w/ Lock Arm Stabilizer Bars



Optional BBQ Grill

FIFTH WHEEL CONSTRUCTION

Heating Diagram

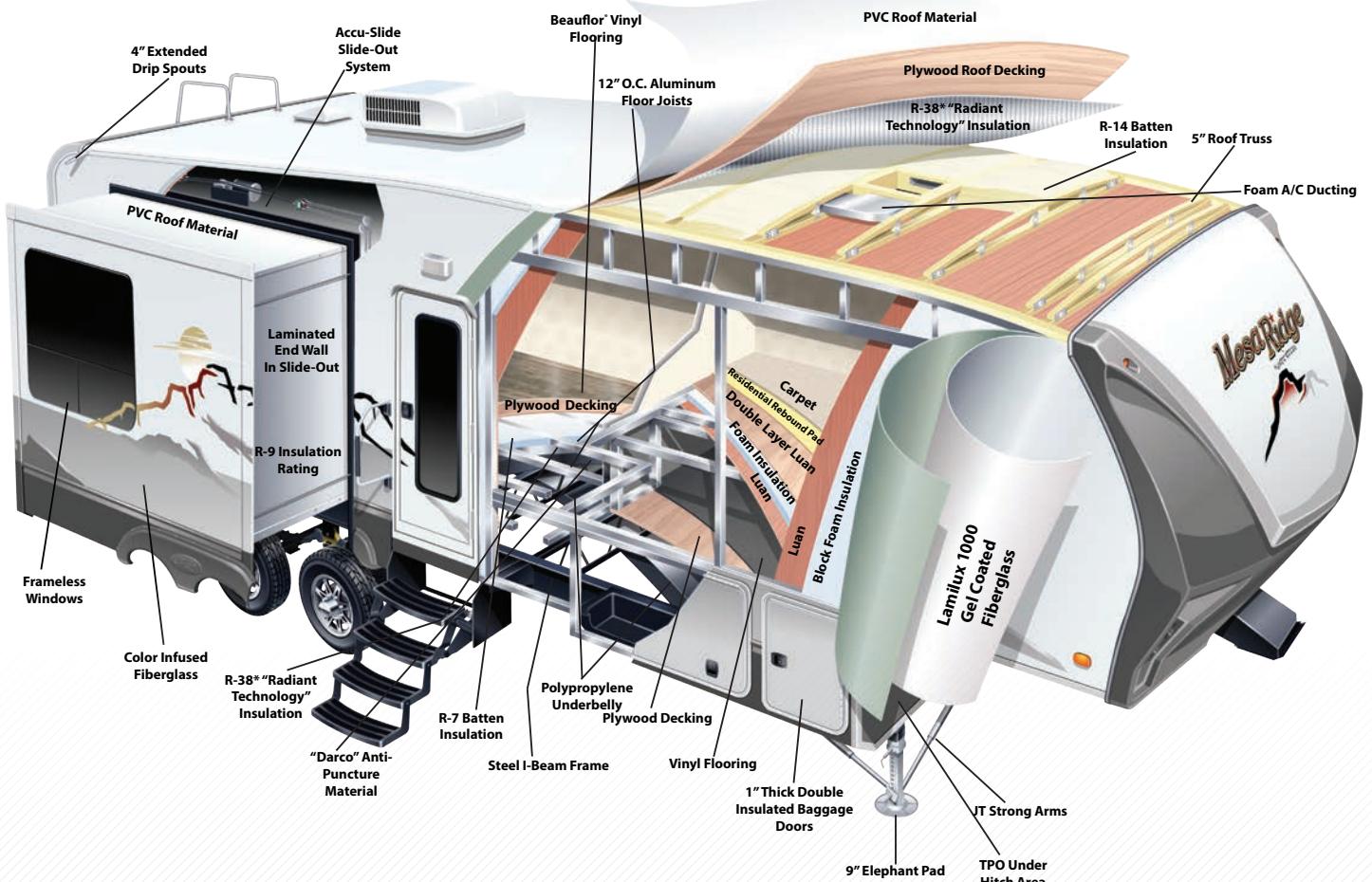
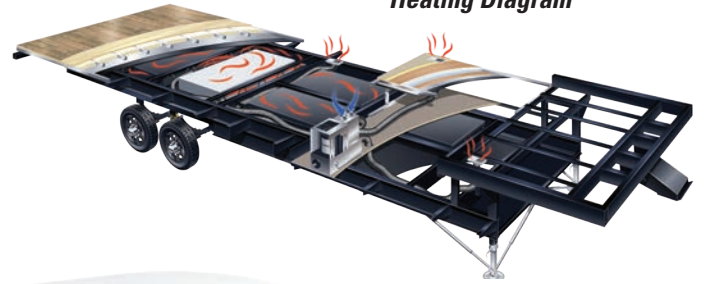

CONSTRUCTION FIFTH WHEEL / TRAVEL TRAILER

HEATING DIAGRAM (SHOWN ABOVE)

Mesa Ridge fifth wheels & travel trailers have a unique and incredible heating system. We start with a 4 inch heat duct from the furnace down the underbelly in place of the 2 inch some of the competitors use. All of our tanks are suspended between the I beams in the underbelly allowing us to have forced air heat blowing from the 4 inch heat duct surrounding the tanks with warm air flow.

How do we get the air flow? Simply by having a return at the end of the tanks going back into the coach. The secret is that simple. We put a return in their underbelly to allow air flow over the tanks instead of a pressurizing system that occurs in other brands.



Seal-Tite Water Shield

Seal-Tite – a semi-robotic system that makes the placement of window sealants more precise and error-free – thus eliminating the hand application of such sealants which can often result in inconsistency.

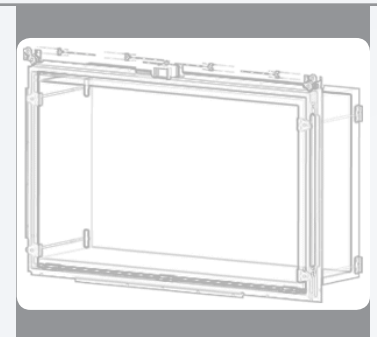

Accu-Slide

Accu-Slide is so ingeniously designed, yet so amazingly simple, you're likely to say it works like magic. A revolutionary, lightweight, heavy-duty system, Accu-Slide increases the quality and customer appeal of RV's through superior performance and increased design flexibility.

TRAVEL TRAILER CONSTRUCTION

Heating Diagram

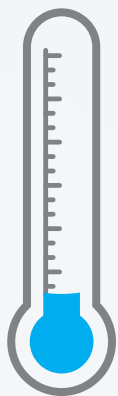
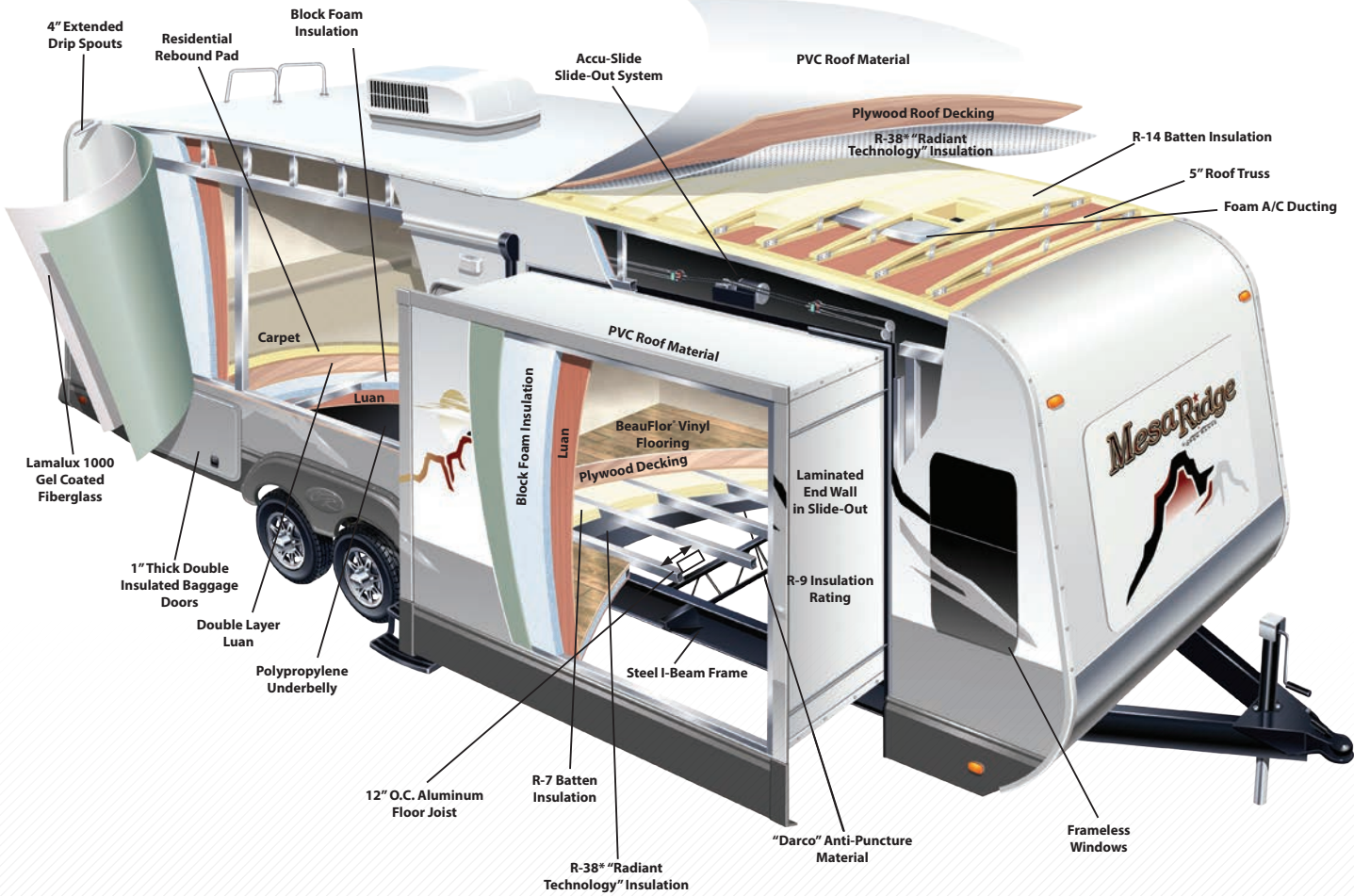
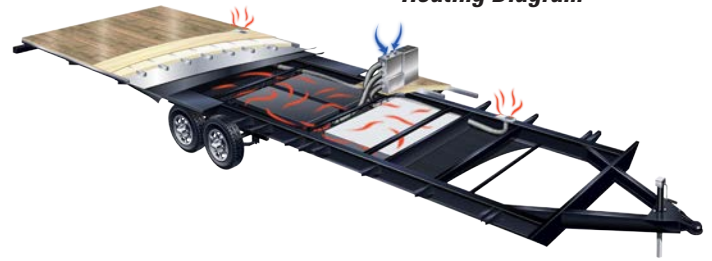

ZERO DEGREE
TESTED
 THE RESULTS

BEDROOM72°F
KITCHEN70°F
SLIDE-OUT66°F
BATHROOM72°F
LIVING ROOM70°F
WASTE WATER TANK62°F
STORAGE UNDER RV58°F

FIFTH WHEEL FLOORPLANS

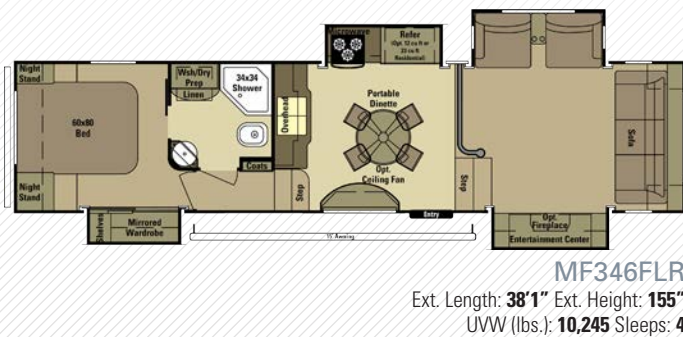
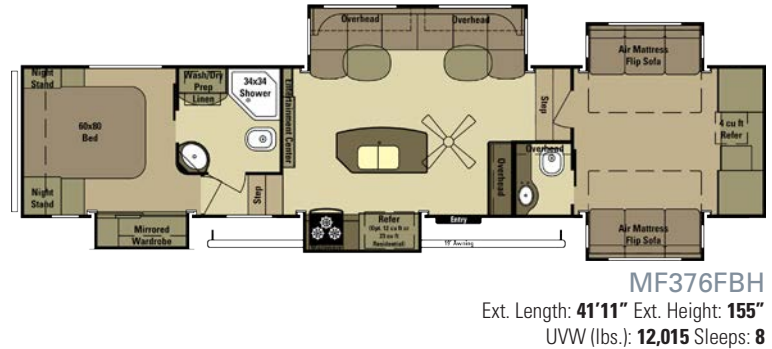
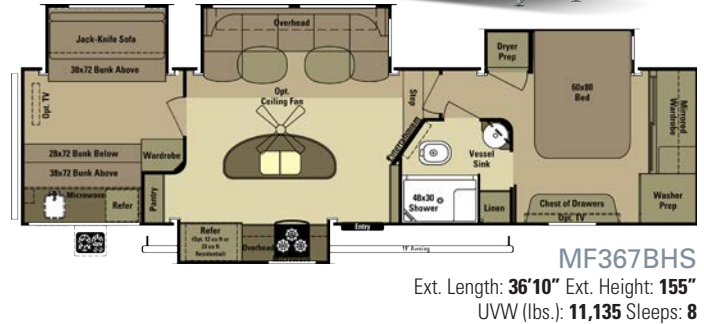
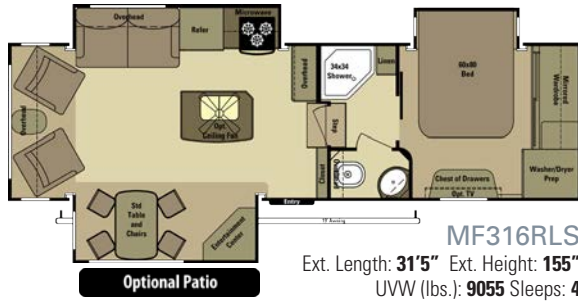

	MF316RLS	MF337RLS	MF345RLS	MF346FLR	MF367BHS	MF376FBH	MF384BHS	MF430RLS
Square Feet	314	350	362	361	382	429	429	428
UWV	9055	9657	9890	10245	11135	12015	12135	11800
Hitch Wt.	2085	2320	2440	2312	2275	2665	2295	2370
Length (Box)	29'11"	32'9"	33'7"	36'10"	35'3"	40'5"	39'9"	41'
Gross NCC	3430	3063	2950	4067	3465	4445	3365	4290
Net NCC	2644	2277	2164	3281	2679	3659	2579	3504
Fresh Water	85 Gal.	85 Gal.	85 Gal.	85 Gal.	85 Gal.	85 Gal.	85 Gal.	85 Gal.
Gray Water	82 Gal.	57 Gal.	57 Gal.	57 Gal.	82 Gal.	98 Gal.	82 Gal.	98 Gal.
Waste Water	41 Gal.	41 Gal.	41 Gal.	41 Gal.	41 Gal.	82 Gal.	82 Gal.	41 Gal.
Sleep Cap.	4	4	4	4	8	8	7	6

TRAVEL TRAILER FLOORPLANS

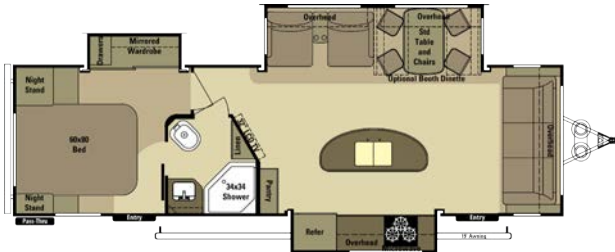

MR288FLR
Ext. Length: **33'6"** Ext. Height: **140"**
UVW (lbs.): **7808** Sleeps: **4**



MR316RLS
Ext. Length: **33'8"** Ext. Height: **140"**
UVW (lbs.): **8007** Sleeps: **4**

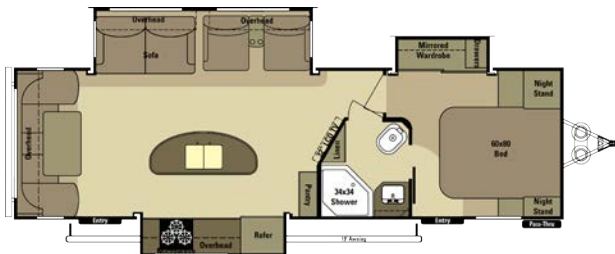

MR291RLS
Ext. Length: **33'6"** Ext. Height: **140"**
UVW (lbs.): **7710** Sleeps: **6**



MR320RES
Ext. Length: **34'6"** Ext. Height: **140"**
UVW (lbs.): **7996** Sleeps: **4**

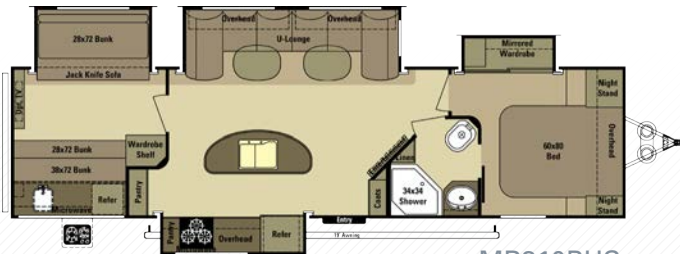

MR310BHS
Ext. Length: **37'3"** Ext. Height: **140"**
UVW (lbs.): **9310** Sleeps: **8**

	MR288FLR	MR291RLS	MR310BHS	MR316RLS	MR320RES
Square Feet	316	316	366	316	315
UVW	7808	7710	9310	8007	7996
Hitch Wt.	978	995	1177	1200	787
Length (Box)	29'10"	29'10"	33'6"	30'1"	31'
Gross NCC	1970	2085	2190	1983	1994
Net NCC	1495	1610	1715	1508	1519
Fresh Water	50 Gal.	50 Gal.	50 Gal.	50 Gal.	50 Gal.
Gray Water	62 Gal.	62 Gal.	62 Gal.	57 Gal.	62 Gal.
Waste Water	31 Gal.	31 Gal.	31 Gal.	31 Gal.	31 Gal.
Sleep Cap.	4	6	8	4	4

DÉCOR OPTIONS



IVORY



LIMESTONE



SONIC

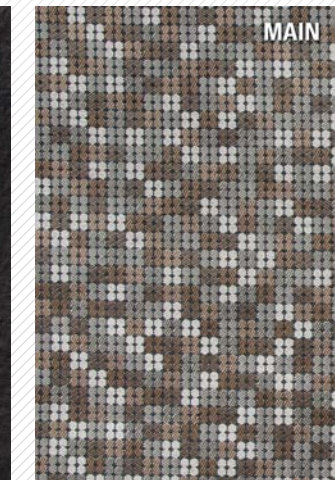

TRAVEL TRAILER STANDARD FEATURES

- » Heavy Duty Full Extension Drawer Guides
- » Large Lavatory Sink
- » Porcelain Toilet w/Foot Pedal Flush
- » Ext. Utility Center w/Black Tank Flush
- » Lippert Wide-Stance Axles
- » Lippert Equa-Flex Suspension
- » LP Quick Connect
- » 60 Lbs of LP Capacity
- » 100" Wide Body Frame
- » Prepped for Back-Up Camera
- » PVC Roof Material
- » Nitrogen Filled Radial Tires
- » 50 Amp Service
- » "Maxx Air" Vent Cover
- » Front & Rear Stabilizer Jacks
- » Power Tongue Jack

TRAVEL TRAILER OPTIONAL FEATURES

- » 24" Bedroom TV
- » 2nd A/C (13.5k BTU Ducted)
- » Dyson Vacuum Cleaner
- » Additional Fantastic Fan(s)
- » French Door(s)
- » Party Room Package (MR310BHS)
- » 2 Bar Stools
- » Dinette Booth IPO Table & Chairs (Select Models)
- » Fireplace (Most Models)
- » 15k Main A/C
- » Ottoman w/Storage
- » Recliners IPO Swivel Rockers (Forced) (Most Models)
- » Dual Pane Windows
- » BBQ Grill
- » One-Piece Fiberglass Front Cap
- » Ladder
- » Lock Arm Stabilizer Bars
- » Power Front & Rear Stabilizer Jacks
- » Rear Storage Tray
- » Slide-Out Awning Covers

SHARED MANDATORY PACKAGES

EXECUTIVE PACKAGE

- » One-Touch Automatic Leveling System (FW)
- » Flat Screen TV in Living Area
- » 12V CD/DVD Player w/Bluetooth®
- » Soundbar in Living Room
- » USB/12V Charging Port
- » Multi-Port Satellite Hook-Up
- » Digital TV Antenna w/Booster
- » Large 8 Cu. Ft. Refrigerator
- » 30" OTR Microwave (FW)
- » 15k BTU A/C w/"Quick Cool" Feature (FW)
- » 10 Gal. Gas/Electric Water Heater (FW)
- » 6 Gal. Gas/Electric Water Heater (TT)
- » Corian® Countertops
- » Fantastic Fan in Kitchen (FW)
- » Power Awning w/LED Awning Light
- » Concealed Hinges
- » Western Aspen Cabinet Doors
- » LED Lighting in Ceiling
- » Crown Molding
- » Wired and Framed for 2nd A/C
- » Full View Vented Entrance Door
- » Frameless Windows
- » Bedroom Speakers

FIFTH WHEEL STANDARD FEATURES

- » Heavy Duty Full Extension Drawer Guides
- » Large Lavatory Sink
- » Porcelain Toilet w/Foot Pedal Flush
- » Ext. Utility Center w/Black Tank Flush
- » Lippert Wide-Stance Axles
- » Lippert Equa-Flex Suspension
- » LP Quick Connect
- » 80 Lbs of LP Capacity
- » 100" Wide Body Frame
- » Prepped for Back-Up Camera
- » PVC Roof Material
- » Nitrogen Filled Radial Tires
- » 50 Amp Service
- » "Maxx Air" Vent Cover

FIFTH WHEEL OPTIONAL FEATURES

- » 24" Bedroom TV
- » 2nd A/C (13.5k BTU Ducted)
- » Dyson Vacuum Cleaner
- » Additional Fantastic Fan(s)
- » French Door(s)
- » Party Room Package (MF367BHS)
- » Appliance Package (23cu SS Refer, 17" SS Oven, & 30" OTR SS Microwave)(Select Models)
- » 12 cu ft Refrigerator (Select Models)
- » 2 Bar Stools
- » Ceiling Fan
- » Fireplace (Most Models)
- » Corian® Island on Castors
- » Ottoman w/Storage
- » Recliners IPO Swivel Rockers (Forced) (Most Models)
- » Dual Pane Windows
- » BBQ Grill
- » LP Generator Prep
- » Rear Storage Tray
- » Slide-Out Awning Covers
- » Metal Wrapped Awning
- » Back-Up Camera
- » Ladder (Forced)

FOUR SEASONS PACKAGE

- » R-38 Insulation in Roof & Floor
- » R-9 Insulation in Sidewall
- » Atwood® High Performance Furnace
- » Heated and Enclosed Underbelly
- » Double Insulated Baggage Doors
- » Heated Storage Area (FW)
- » Digital Thermostat
- » Insulated Slide Floors
- » Heated & Enclosed Dump Valves



At Highland Ridge RV, Inc., we are one of the few manufacturers that have a 2-Year Limited Transferable Warranty. Ensuring our customers that we will stand behind our product for twice the amount of time that other manufacturers offer.

MORE ROOM LESS WEIGHT

This is our mission at Highland Ridge RV, Inc. It's the life blood that runs in our veins. It drives us to innovate and revolutionize the RV industry and it's why our products are 10 - 15% lighter than the competition.

Your Mesa Ridge Dealer:



Highland RIDGE RV

LIVING LARGE / TRAVELING LIGHT

For more information visit us at:
www.HighlandRidgeRV.com

