



Jayco[®]

Generations of family fun.

WHITE HAWK

2015 ULTRA LITE TRAVEL TRAILERS BY JAYCO



This 1987 brochure cover inspired our 2015 literature.

2
YEAR
WARRANTY

BUILT TO **broaden** YOUR IDEA OF FAMILY FUN



WHITE HAWK ULTRA LITE

WHITE HAWK SUMMIT EDITION

For 45 years, Jayco has helped create generations of family fun, and over the course of that time, fun still looks remarkably the same. From campfires to fishing, from relaxing to eating, fun has the same feel generations later—and all with a Jayco RV nearby. Today, we're the largest family-owned RV manufacturer in the world, and our promise is to continually strive to build family-friendly products that will outlast just about everything but your memories. Join us in our generations of family fun.

On the cover: The 1987 brochure artwork, illustrated by Tim MacDonald, was part of a successful ad campaign. These illustrations inspired the 2015 Jayco brochure covers, which are live re-creations of Tim's artwork.



Scan this QR code to watch how Jayco delivers Generations of Family Fun or visit www.GenerationsOfFamilyFun.com.

Boasting 36" deep slideouts,* the 2015 White Hawk is unlike any other ultra lite. It doesn't skimp on space, meaning you don't have to skimp on amenities. So go light. We'll only go heavy on the fun.

TWICE THE EXPANDABLE LIVING SPACE

Arched interior rafters and deep-wide slides* combine the space you crave with the amenities your family will love in our White Hawk Summit Edition, a top-of-the-line spacious retreat.



wide slide [36" deep slideout]*



AND TWICE THE FUN OUTSIDE

At Jayco, we know just how fun the Great Outdoors can be, so we put as much thought into the White Hawk exterior as we do into its well-planned interiors. Starting with an Indoors-Out kitchen,* White Hawk flaunts an exterior refrigerator, microwave and two-burner stove. And to easily get to all your outdoor gear, the Summit Package features slam latch baggage doors on the front pass-thru storage.

*Available on select models



WHITE HAWK ULTRA LITE 23MBH | BRICK

White Hawk

Ultra Lite

Load up on fun without weighing yourself down. Thanks to smart design and innovative floorplans, like our Murphy bed model, the 2015 White Hawk Ultra Lite maximizes space so that you can hit the road running in our legendary lightweight, towable by most SUVs.*

* Consult with your authorized automobile manufacturer or vehicle owner's manual; some models require a tow package.



WHITE HAWK ULTRA LITE 23MBH | BRICK



WHITE HAWK ULTRA LITE 23MBH | MURPHY BED



THE SUV-FRIENDLY TRAVEL TRAILER

	LENGTH	23' 11" - 28' 10"
	WEIGHT	4,355 - 4,925 lbs.
	SLEEPS	2 - 8



SUVs

MAKE	MODEL	ENGINE
Toyota	Sequoia	All
Volkswagen	Touareg	All
Land Rover	Range Rover	5.0L V-8
Chevy	Tahoe*	4WD 5.3L V-8
GMC	Yukon*	4WD 5.3L V-8
Ford	Expedition EL**	4WD 5.4L V-8

* 3.42:1 axle ratio, cooling or other accessory package required
 ** Towing package required



WHITE HAWK ULTRA LITE 23MBH | BRICK



WHITE HAWK ULTRA LITE 23MBH | BRICK



WHITE HAWK SUMMIT EDITION 33BHBS | FAWN

White Hawk

Summit Edition

With so many premium standards, the 2015 White Hawk Summit Edition is a top-of-the-line lightweight package. Its many high-end amenities start in the Elite Kitchen, featuring decorative backsplash, a standard 8 cu. ft. refrigerator and stunning Amish-crafted cabinetry with beadboard inserts.



WHITE HAWK SUMMIT EDITION 33BHBS | FAWN



WHITE HAWK SUMMIT EDITION 27RBOK | COFFEE



MADE FOR FAMILY DINNERS

Mealtime is important, so we make the most of it with frameless MaxView windows, ample storage, spacious U-dinettes* and EZ-Chair Dinettes with sliding tabletop.* *Available on select White Hawk models.



WHITE HAWK SUMMIT EDITION 27RBOK | COFFEE



WHITE HAWK SUMMIT EDITION 33BHBS | FAWN

WHITE HAWK ULTRA LITE FLOORPLANS

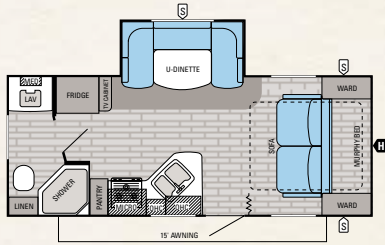

WHITE HAWK | 20MRB

Ext. Lgth: 23' 11" Ext. Ht: 128" Unloaded Wt (lbs.): 4,385 Sleeps: 2-4

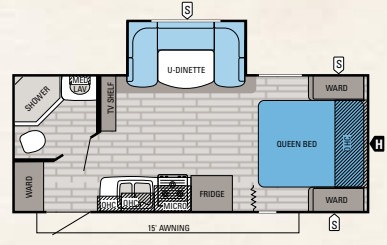

WHITE HAWK | 21FBS

Ext. Lgth: 24' 11" Ext. Ht: 128" Unloaded Wt (lbs.): 4,355 Sleeps: 3-4

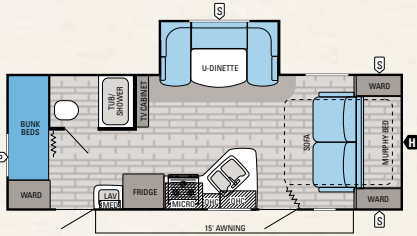

WHITE HAWK | 23MBH

Ext. Lgth: 26' 4" Ext. Ht: 128" Unloaded Wt (lbs.): 4,680 Sleeps: 5-6

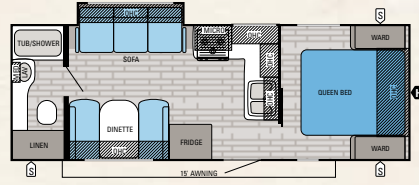

WHITE HAWK | 24RBS

Ext. Lgth: 27' 8" Ext. Ht: 128" Unloaded Wt (lbs.): 4,460 Sleeps: 4-6

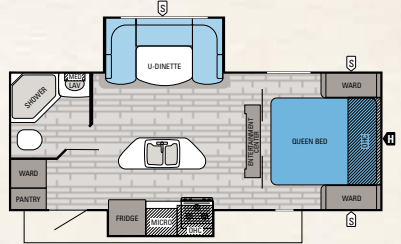

WHITE HAWK | 24RDB

Ext. Lgth: 25' 10" Ext. Ht: 129" Unloaded Wt (lbs.): 4,710 Sleeps: 3-4

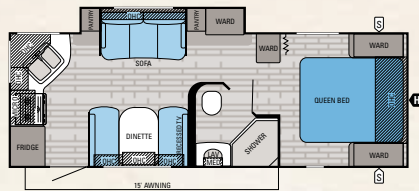

WHITE HAWK | 24RKS

Ext. Lgth: 27' 11" Ext. Ht: 128" Unloaded Wt (lbs.): 4,745 Sleeps: 4-6

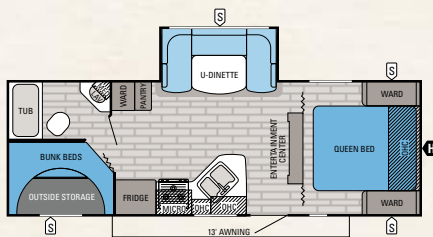

WHITE HAWK | 25BHS OPTION: B

Ext. Lgth: 28' 10" Ext. Ht: 127" Unloaded Wt (lbs.): 4,925 Sleeps: 7-8

OPTIONS

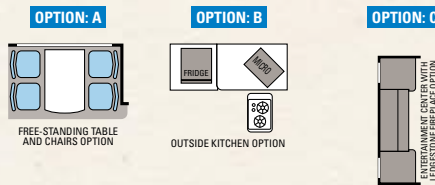

WHITE HAWK ULTRA LITE SPECIFICATIONS

MODELS	DIMENSIONS				WEIGHTS (LBS.)				TANKS (GALS.)			
	FLOORPLAN	EXTERIOR TRAVEL LENGTH	EXTERIOR WIDTH	EXT. HEIGHT (WITH A/C)	INTERIOR HEIGHT	UNLOADED VEHICLE WEIGHT *	DRY HITCH WEIGHT	GROSS VEHICLE WEIGHT RATING	CARGO CARRYING CAPACITY	FRESH (INCLUDES WATER HEATER)	GRAY	BLACK
20MRB		23' 11"	96"	128"	78"	4,385	540	5,950	1,565	48	30.5	30.5
21FBS		24' 11"	96"	128"	78"	4,355	430	6,250	1,895	48	30.5	30.5
23MBH		26' 4"	96"	128"	78"	4,680	655	6,500	1,820	48	30.5	30.5
24RBS		27' 8"	96"	128"	78"	4,460	485	5,950	1,490	48	45	30.5
24RDB		25' 10"	96"	129"	78"	4,710	505	6,500	1,790	48	30.5	30.5
24RKS		27' 11"	96"	128"	78"	4,745	530	6,250	1,505	48	45	30.5
25BHS		28' 10"	96"	127"	78"	4,925	590	6,500	1,575	48	30.5	30.5

* The weights of certain options and/or option packages are not included in the UWW listed in the specification chart.

Unloaded Vehicle Weight (UWW): Sometimes referred to as "Dry Weight," UWW means the typical weight of this trailer as built at the factory. The UWW, as used in product literature and other promotional materials, does not include cargo, fresh water, propane, options or dealer-installed accessories.

Gross Vehicle Weight Rating (GVWR): GVWR means the maximum permissible weight of the trailer, including the UWW plus passengers, personal items, all cargo, fluids, options, and dealer-installed accessories. The GVWR is equal to or greater than the sum of the UWW and the CCC.

Cargo Carrying Capacity (CCC): CCC means the maximum weight of all passengers, personal items, food, fresh water, propane, tools, other cargo and dealer-installed accessories that can be carried by the trailer. CCC is equal to or less than GVWR minus UWW. The addition of options will decrease the CCC.

Hitch Weight (HW): The hitch weight, as used in product literature and other promotional materials, does not include cargo, fresh water, propane gas, options or dealer-installed accessories. The addition of these types of items will either add to or subtract from the stated hitch weight.

WHITE HAWK SUMMIT EDITION FLOORPLANS

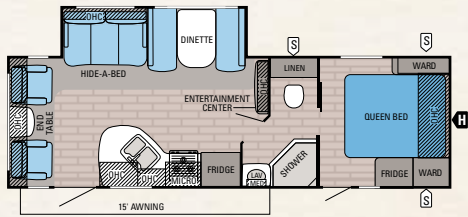

WHITE HAWK | 27DSRL **OPTION: A**
Ext. Lgth: 30' 11" Ext. Ht: 132" Unloaded Wt (lbs.): 5,435 Sleeps: 3-6

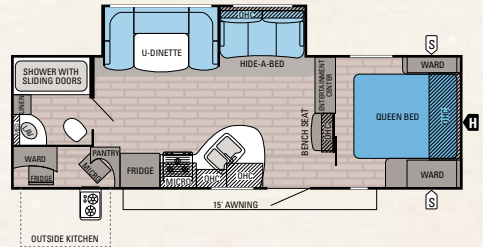

WHITE HAWK | 27RBOK **OPTION: A**
Ext. Lgth: 30' 11" Ext. Ht: 132" Unloaded Wt (lbs.): 5,390 Sleeps: 3-6

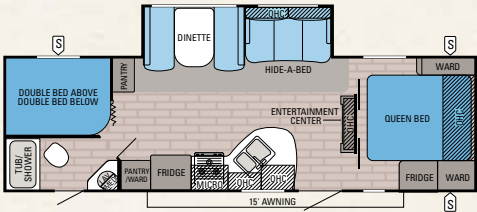

WHITE HAWK | 28DSBH **OPTION: A**
Ext. Lgth: 31' 11" Ext. Ht: 131" Unloaded Wt (lbs.): 5,460 Sleeps: 7-10

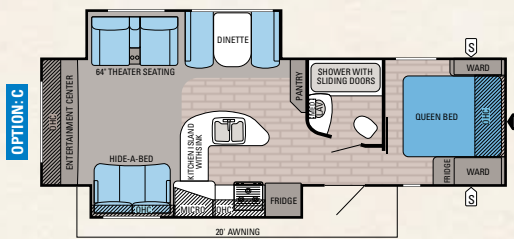

WHITE HAWK | 29REKS **OPTION: A**
Ext. Lgth: 33' 1" Ext. Ht: 133" Unloaded Wt (lbs.): 6,475 Sleeps: 3-6

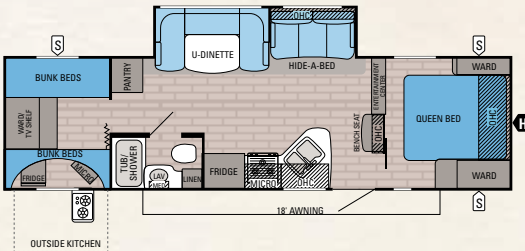

WHITE HAWK | 30DSQB **OPTION: A**
Ext. Lgth: 34' 5" Ext. Ht: 134" Unloaded Wt (lbs.): 6,025 Sleeps: 6-9

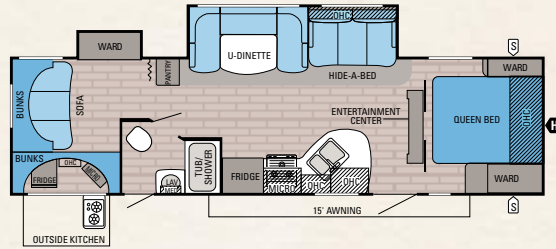

WHITE HAWK | 31DSL B **OPTION: A**
Ext. Lgth: 34' 11" Ext. Ht: 133" Unloaded Wt (lbs.): 6,270 Sleeps: 6-10

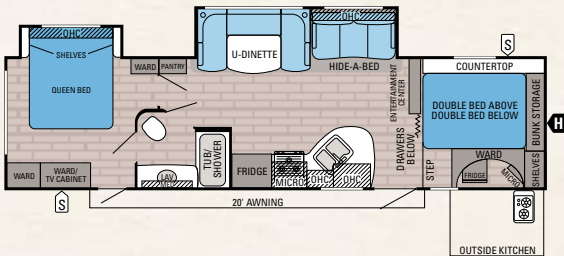

WHITE HAWK | 33BHBS **OPTION: A**
Ext. Lgth: 36' 7" Ext. Ht: 134" Unloaded Wt (lbs.): 6,740 Sleeps: 7-10

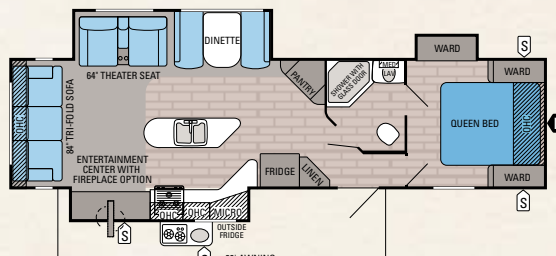

WHITE HAWK | 33RSKS **OPTION: A**
Ext. Lgth: 37' Ext. Ht: 135" Unloaded Wt (lbs.): 7,070 Sleeps: 4-6

WHITE HAWK SUMMIT EDITION SPECIFICATIONS

MODELS	DIMENSIONS				WEIGHTS (LBS.)				TANKS (GALS.)		
	FLOORPLAN	EXTERIOR TRAVEL LENGTH	EXTERIOR WIDTH	EXT. HEIGHT (WITH A/C)	INTERIOR HEIGHT	UNLOADED VEHICLE WEIGHT*	DRY HITCH WEIGHT	GROSS VEHICLE WEIGHT RATING	CARGO CARRYING CAPACITY	FRESH (INCLUDES WATER HEATER)	GRAY
27DSRL	30' 11"	96"	132"	81"	5,435	510	7,500	2,065	48	30.5	30.5
27RBOK	30' 11"	96"	132"	81"	5,390	615	7,750	2,360	48	45	30.5
28DSBH	31' 11"	96"	131"	81"	5,460	635	7,500	2,040	48	45	30.5
29REKS	33' 1"	96"	133"	81"	6,475	655	8,500	2,025	48	61	30.5
30DSQB	34' 5"	96"	134"	81"	6,025	775	8,250	2,225	48	45	30.5
31DSL B	34' 11"	96"	133"	81"	6,270	805	8,200	1,930	48	45	30.5
33BHBS	36' 7"	96"	134"	81"	6,740	865	8,500	1,760	48	45	30.5
33RSKS	37'	96"	135"	81"	7,070	785	9,000	1,930	48	61	30.5

It is important for your safety and enjoyment that your tow vehicle be adequately sized and equipped to tow and handle the GVWR of the RV you select. Review weights and rating of your tow vehicle and consult a competent advisor for questions or advice. Whether you are new to RVing or a veteran, get a feel for the performance of your tow vehicle before heading out on the roadways. When you tow an RV, you must drive differently than when you drive a single vehicle. Practice hooking up, driving, backing up and braking in a safe environment or seek out professional instruction. Jayco affixes a weight label to each RV which lists weight information for that vehicle. See specifications chart above and left.

* The weights of certain options and/or option packages are not included in the UWW listed in the specification chart.

WE START WITH ONE OF THE INDUSTRY'S **strongest** foundations

Jayco builds on custom-sized frames, designed specifically for each floorplan. Other manufacturers use stock frames, stretching and welding the frame to fit.

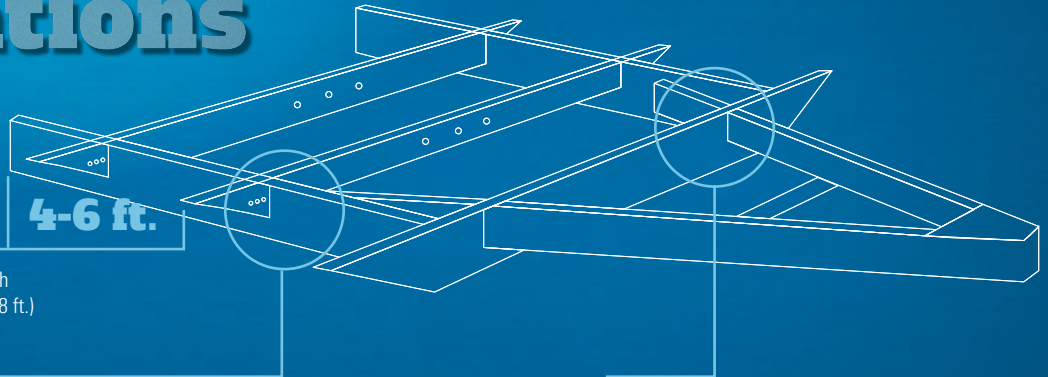

Full-width outriggers: We build on full-width outriggers that are spaced 4-6 feet apart (vs. 8 ft.) to better support the weight of the wall.

Norco NextGen frame: White Hawk features the industry's strongest strength-to-weight ratio thanks to a Norco NextGen frame made of high-strength, low-alloy sheet steel, huck bolts and an interlocking design.

Integrated A-frame: The A-frame runs through the main frame, preventing the hitch from buckling like competing tack-welded designs.

– so that we can build the industry's most reliable RV



WALL CONSTRUCTION lightweight techniques

- 1 The walls are vacuum bonded using 15-18 minutes of 144 tons of pressure to ensure a strong bond.
- 2 Lightweight materials, like welded aluminum frames with metal backers, and White Hawk's innovative, aerodynamic profile increase towability.
- 3 Extra-wide corner seals on the entry doors, baggage compartment and window seals prevent leaks.

FLOOR CONSTRUCTION made for foot/road traffic

- 4 Jayco prides itself on building a solid foundation. Backed by computer monitoring and constant quality control checks, White Hawk's vacuum-bonded floor delivers long-lasting durability.
- 5 To stand up to family foot traffic, Jayco uses only the best flooring materials, Diamondflor vinyl, a Congoleum product with ArmorGuard that is built to withstand cold, cracks and scratches. Jayco's seamless application keeps flooring intact.

JAYCO'S ROOF vs OTHER ROOFS



4,500 LBS. ON A JAYCO ROOF VS. OTHER ROOFS

THE MAGNUM TRUSS ROOF SYSTEM 50 percent stronger

In a side-by-side comparison test, Jayco's exclusive Magnum Truss Roof System withstood 4,500 lbs. — 50 percent more than other roofs. The difference?

- 6 Jayco uses 4 1/2" crowned wood trusses, solid-wood studs and oversized nail plates to maximize the roof's load capacity.
- 7 Then, we screw down 3/8" roof decking at every seam, a process that is more durable than stapled construction.
- 8 Finally, our one-piece, sidewall-wrapped DiFlex II material provides the ultimate in leak protection.



TO SEE THE SIDE-BY-SIDE ROOF
COMPARISON, SCAN HERE WITH
YOUR SMARTPHONE.

WHITE HAWK ULTRA LITE

STANDARD EXTERIOR EQUIPMENT

Deluxe Graphics Package with Champagne paint-infused fiberglass front wall, back wall and sidewall color band
TuffShell vacuum-bonded laminated sidewalls, front and rear walls and floors
Magnum Truss Roof System with one-piece, seamless DiFlex II material
Norco NextGen frame
Marine-grade outside speakers (2)
Frameless G20 dark-tinted windows
Radial tires with aluminum rims
Galvanized-steel, impact-resistant wheel wells
Wide-stance Tracker Wide Axles with E-Z Lube maintenance
Aerodynamic, rounded front profile
Front diamond plate
Completely enclosed and protected electric slide mechanisms
Utility Lighting System: Entrance step, baggage compartment, hitch and dump station light
30-amp service
Dual 20-lb. propane bottles with auto regulator
Stabilizer jacks with sand pads (4)

STANDARD INTERIOR EQUIPMENT

Elite Kitchen: Overhead cabinetry with etched-glass and bead-board inserts; kitchen skylight; large, rounded countertops; deep bowl, 60/40 acrylic sink with brushed-nickel, high-rise faucet; 8 cu. ft. Norcold refrigerator with magnet-friendly panels (6 cu. ft. in 24RDB); 3-burner range with 9,000-BTU SuperBurner with piezo igniter; 12" decorative backsplash
Ball bearing drawer guides, 75-lb. capacity, full-drawer extension
Plywood dinette, bunk and bed bases
EZ-Chair Dinette with sliding tabletop (select models)
Diamondflor vinyl flooring
Wood-grain accent paneling on select interior walls
Rounded, residential jack-knife sofa
High-output Atwood auto ignition furnace with wall thermostat
Directional/closeable central air conditioner vents
AM/FM/CD home theater-style DVD player and Bluetooth
22" LED HDTV (20MRB)
26" LED HDTV (21FBS, 23MBH, 24RBS and 24RKS)
32" LED HDTV (24RDB and 25BHS)
Pillowtop Denver Mattress
Full-height shirt wardrobes in front walk-around bedroom models
Medicine cabinet

CUSTOMER VALUE PACKAGE (MANDATORY)

Aluminum rims
Electric tongue jack
ABS propane bottle cover
Electric patio awning with LED lights
Spare tire and carrier
Outside shower
13,500-BTU air conditioner
Microwave with built-in range hood and light
Oven
6 gal. gas/electric DSI water heater
Bath skylight
Tub surround

OPTIONS

Glacier Package with fully enclosed underbelly
Outside kitchen (25BHS)
Outside bumper-mount grill
Customer Value Package with 15,000-BTU air conditioner
Roof ladder



SMOOTH-RIDING TRACKER WIDE AXLES

WHITE HAWK SUMMIT EDITION

STANDARD EXTERIOR EQUIPMENT

Deluxe Graphics Package with Champagne paint-infused fiberglass front wall, back wall and sidewall color band
TuffShell vacuum-bonded laminated sidewalls, front and rear walls and floors
Magnum Truss Roof System with one-piece seamless DiFlex II material
Norco NextGen frame
Marine-grade outside speakers (2)
Frameless G20 dark-tinted windows
Radial tires
Galvanized-steel, impact-resistant wheel wells
Wide-stance Tracker Wide Axles with E-Z Lube maintenance
Aerodynamic, rounded front profile
Front diamond plate
Completely enclosed and protected electric slide mechanisms
Indoors-Out Camp Kitchen: Stove, microwave and refrigerator (27RBOK, 30DSQB, 31DSL, 33BHBS and 33RSKS)
Utility Lighting System: Entrance step, baggage compartment, hitch and dump station light
30-amp service
Dual 20-lb. propane bottles with auto regulator
Stabilizer jacks with sand pads (4)

STANDARD INTERIOR EQUIPMENT

Elite Kitchen: Overhead cabinetry with etched-glass and bead-board inserts; kitchen skylight; large, rounded countertops; deep bowl, 60/40 acrylic sink with brushed-nickel, high-rise faucet; 8 cu. ft. Norcold refrigerator with magnet-friendly panels; 3-burner range with 9,000-BTU SuperBurner with piezo igniter; 12" decorative backsplash
Ball bearing drawer guides, 75-lb. capacity, full-drawer extension
Plywood dinette, bunk and bed bases
EZ-Chair Dinette with sliding tabletop (select models)
Large MaxView tinted safety-glass dinette window (60" on standard dinettes, 70" on U-dinettes)
Diamondflor vinyl flooring
Wood-grain accent paneling on select interior walls
Hide-a-bed sofa with tri-fold Denver Mattress
High-output Atwood auto ignition furnace with wall thermostat
Directional/closeable central air conditioner vents
AM/FM/CD home theater-style DVD player and Bluetooth
Pillowtop Denver Mattress
Full-height shirt wardrobes in front walk-around bedroom models
Medicine cabinet

SUMMIT EDITION PACKAGE (MANDATORY)

Enclosed underbelly
Slam latches on front pass-thru baggage doors
30" main entrance door
Exterior refrigerator
Roof ladder
Arched interior ceiling
Crown molding and wood batten strips in living room
32" LED HDTV

CUSTOMER VALUE PACKAGE (MANDATORY)

Aluminum rims
Electric tongue jack
ABS propane bottle cover
Electric patio awning with LED lights
Outside shower
Spare tire and carrier
13,500-BTU air conditioner
Microwave with built-in range hood and light
Oven
6-gal. gas/electric DSI water heater
Bath skylight
Tub surround

OPTIONS

Summit Edition Package (mandatory)
Glacier Package
Outside bumper-mount grill
Electric stabilizer jacks (4)
Customer Value Package with 15,000-BTU air conditioner
50-amp service and prep for 2nd air conditioner (select models)
2nd air conditioner (select models)
Free-standing table with 4 chairs
Ledgestone fireplace with 40" LED HDTV (29REKS)
Fireplace (33RSKS)

INTERIOR DÉCOR CHOICES

COFFEE



FAWN



STONE

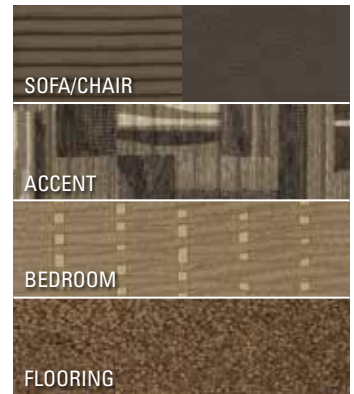

BRICK

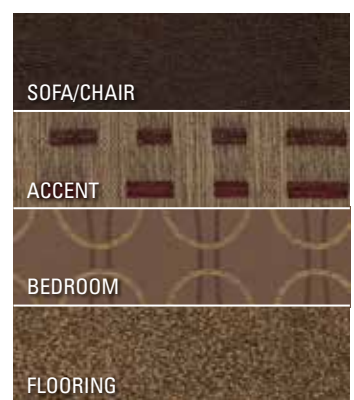

2
YEAR
WARRANTY



Bumper-to-hitch limited warranty*

Jayco[®]

Generations of family fun.

FAMILY fun
starts with peace of mind

At Jayco, we build our RVs to handle every adventure, then we back our products with an industry-leading 2-year limited warranty. You won't find a better warranty in the business because the only strings we attach are those that deliver the ultimate in reliability. That's the Jayco difference. So go explore. We have the warranty that will follow you anywhere.

*For a copy of our 2-year limited warranty with full terms and conditions, please contact your local Jayco dealer.

FREE Roadside Assistance

Travel worry-free with Jayco's Customer First Roadside Assistance program, yours at no cost during the first year of ownership. This program is offered through Coach-Net, the country's largest RV emergency road service, and gives you immediate access to assistance.

eco advantage™

Jayco's long-term commitment to generations of family fun



Scan this QR code with your smartphone to watch a video about our efforts and the impact we're making on our planet.

ecoadvantage.jayco.com

The fun starts with your local Jayco dealer

Your local dealer

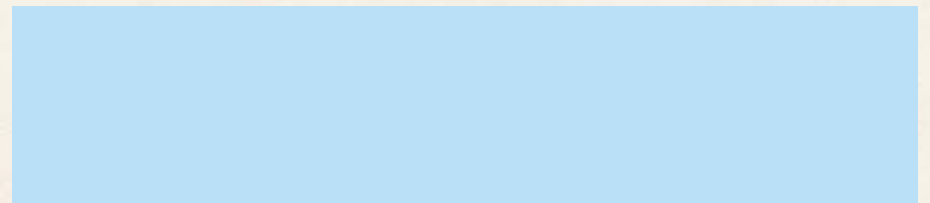

From giving advice to selling and servicing products, we consider our loyal dealers the glue in our family bond. Establishing a solid relationship with your local Jayco dealer is a key component in the enjoyment of your new Jayco. By purchasing from a local dealer, you will have a convenient location for sales, parts and service support. We hope you consider them a part of your camping family.

Follow Jayco



Jayco, Inc., P.O. Box 460, Middlebury, IN 46540, www.jayco.com See dealer for further information and prices. All information in this brochure is the latest available at the time of publication approval. Jayco reserves the right to make changes and to discontinue models without notice or obligation. Photos in this brochure may show optional equipment and props for photography purposes. RVs built for sale in Canada may differ to conform to Canadian codes. ©2014 Jayco, Inc. 15-WTHK-PL 0514-100K Printed in U.S.A.