

Excel

2014 FIFTH WHEELS & TRAVEL TRAILERS



UNBEATABLE WARRANTIES



With Excel's Minus Ten Degree Guarantee, you can be sure your holding tanks, water tank, interior water lines and other essential plumbing won't freeze – all the way down to minus ten degrees!*

* See your dealer for complete explanation of product warranties. The Minus Ten Degree Guarantee is in effect on all 2008 and later models with Thermopane windows installed. Furnace must be in operation for guarantee to be in effect.



Excel's 2-Year Limited Warranty covers material and workmanship of the steel frame, wood structure, laminated sidewalls, roof, and other parts/assemblies manufactured by Peterson Industries, Inc. for two full years after your original date of purchase. It's our promise that your Excel is built to last. Equipment and appliances are covered by manufacture warranties.

Peterson Industries is proud to use these suppliers who share our commitment to quality and service:



Cummins Onan



VIZIO



Hehr International, Inc.



OUTSTANDING CONSTRUCTION SETS US APART



- 2" x 4" tapered roof design provides outstanding run-off – shedding rain and snow more effectively and completely than flat roofs. Plus, we now offer an optional Rhino-Eco-Coat Roof System that's maintenance-free, 100% seamless and comes with a limited lifetime warranty.

- Wood frame construction is especially beneficial to full-timers because of its strength, durability, and comfort.

- Full 5/8" plywood floors are sturdy, quiet, and give your home a solid base.

- Heated basement area protects under-floor systems and stored items from weather extremes.

- Exclusive "Walk-Anywhere" one-piece seamless rubber roof (Winslow) and molded gel-coated fiberglass roof (Limited) are not only easy to maintain, but provide an exceptional barrier against the elements.

- Gel-coated fiberglass exterior gives your Excel a beautiful, easy-to-clean, durable outer skin that is virtually impervious to the elements.

- R10 sidewall insulation and R17 floor and roof insulation help keep the coach cozy in winter and cool in summer, while also saving on heating and cooling costs.

- Standard pin height is adjustable from 41½" to 45½".

- Our exclusive "Drop Z" frame design provides a lower center of gravity for easy towing stability and more useful basement storage. We use a box tube frame for unbeatable strength and durability.

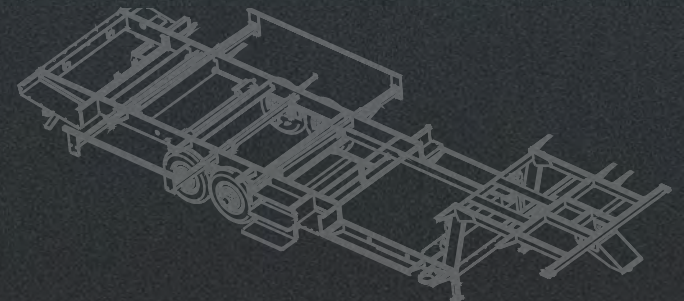

New Entry
Design on
Some Models

See Page 4



WINSLOW

Available in 28, 31, 34, 37, and 38-foot models, Winslow sets the adventurous traveler up in style and affordable luxury. The bold profile and optional paint and graphics package make a statement. An interior wrapped in rich hickory or glazed maple woodwork, and comfortable amenities invite you to stretch out and unwind after a day spent exploring.

The Winslow Travel Trailer makes innovative use of Excel's groundbreaking "Drop-Z" box tube frame, providing more than 100 cubic feet of basement storage — space unheard of in the travel trailer industry!



LIMITED

If your idea of travel involves 5-star accommodations and a long list of innovative and convenient features, the Limited is for you. Standard features include many extras that are either optional or unavailable on other models, like a 42" HD LCD television, LED interior lighting and tail/clearance lights, an industry-first pillow-top mattress with box springs, and so much more.



WILD CARGO

Bring your 4-wheeler, golf cart, motorcycle or snowmobile along, and you'll be set for fun wherever you go. The Wild Cargo's spacious garage area accommodates all this and more. Seating that folds into a double bed is optional in the cargo area, and a drop-down overhead bunk offer plenty of room for guests. The beautiful interior surrounds you with all the creature comforts of home.

WINSLOW



Our SDF floor plan is the first in the RV industry with a walk-in door in the main slide-out.



A WHOLE NEW EXPERIENCE

Affordable luxury is par for the course in our Winslow line, with standard features like a 42 inch LCD-HD TV, hickory woodwork, and a host of attractive options and unique features throughout every floor plan. The Winslow features a bold exterior profile and graphics package that announces your arrival wherever you go. Excel is among the few fifth wheel manufacturers in the country to build a frame strong enough to support an optional Class 3 receiver hitch capable of pulling 4,000 pounds or our optional frame-mounted Hydralift™ that's capable of hauling a touring bike.



NEW
on Select
Models

Entry Door In Slide-Out!

A patent pending design allows the entry steps to easily fold up and lock in place for transport, plus they accommodate varying terrain heights without manual adjustments. Moving the front door creates a spacious layout with exciting amenities, including:

- A half bath on the main level that can even be accessed while the slide-outs are retracted for transport
- A master bath in the front of the coach, with double sinks, king-size shower, and room for a washer/dryer
- A master closet spanning the length of the bedroom slide-out, for more storage space that is easy to access



WINSLOW



WINSLOW TT



Peterson Industries is proud to offer the Winslow Travel Trailer for the customer who prefers one-level living, and wants to maintain use of the truck bed. Full-timers and serious RVers will find the storage solutions in the Winslow TT especially attractive. Storage problems associated with other travel trailers have been solved completely in the Winslow TT. In fact, it's the only travel trailer in the industry to offer 120 cubic feet of basement storage in the front third of the coach. We achieve this by utilizing our exclusive "Drop Z" 8-inch box tube frame. Available in three floor plans, they are packed with the same cutting-edge design and spectacular features found in our 5th wheels.



D311KE FLOOR PLAN



D37FLE FLOOR PLAN

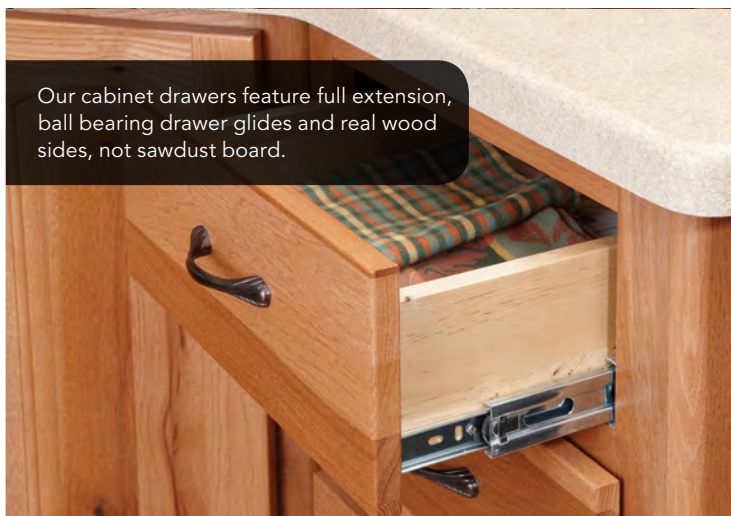

Our cabinet drawers feature full extension, ball bearing drawer glides and real wood sides, not sawdust board.

DT33CKE

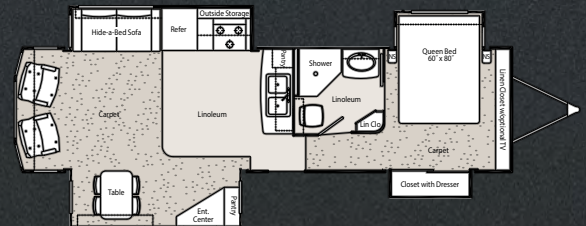

DT33RLE

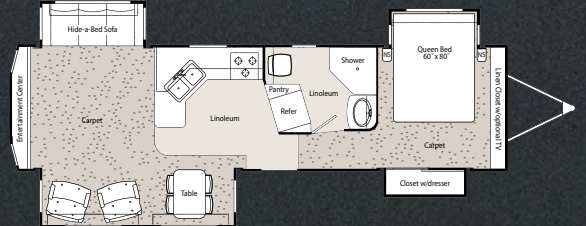

DT33IKE

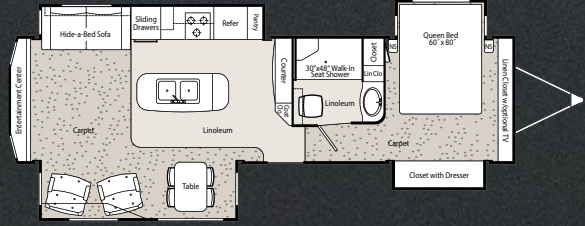

There are optional bath configurations available in the TT, including the "Home Shower" or "Enclosed Bath."

WINSLOW



The new SDF bedroom comes standard with a 60 x 80 queen mattress (or optional king) and features ample storage under the bed.

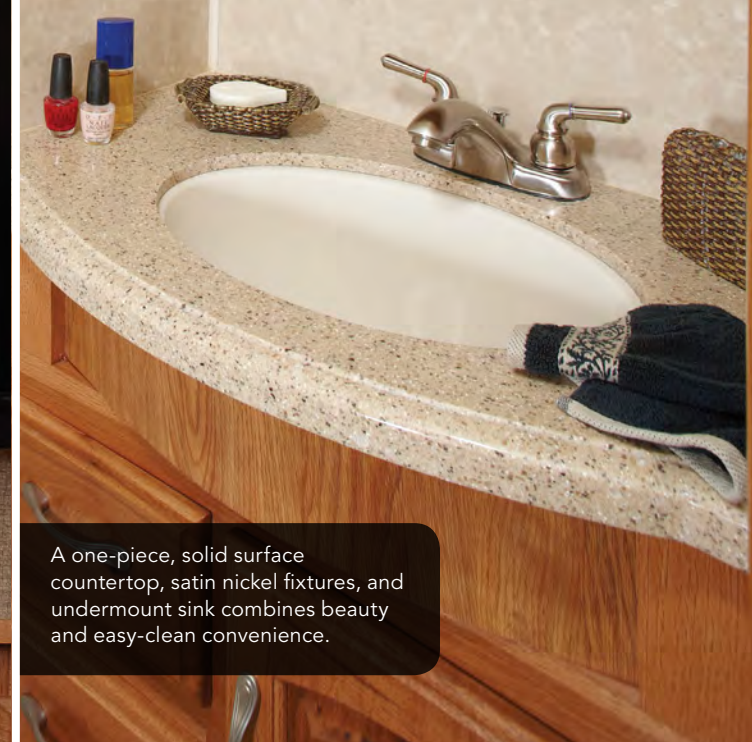

A one-piece, solid surface countertop, satin nickel fixtures, and undermount sink combines beauty and easy-clean convenience.



The new SDF floor plan features a front bath with his and hers sinks and room for an optional washer/dryer.

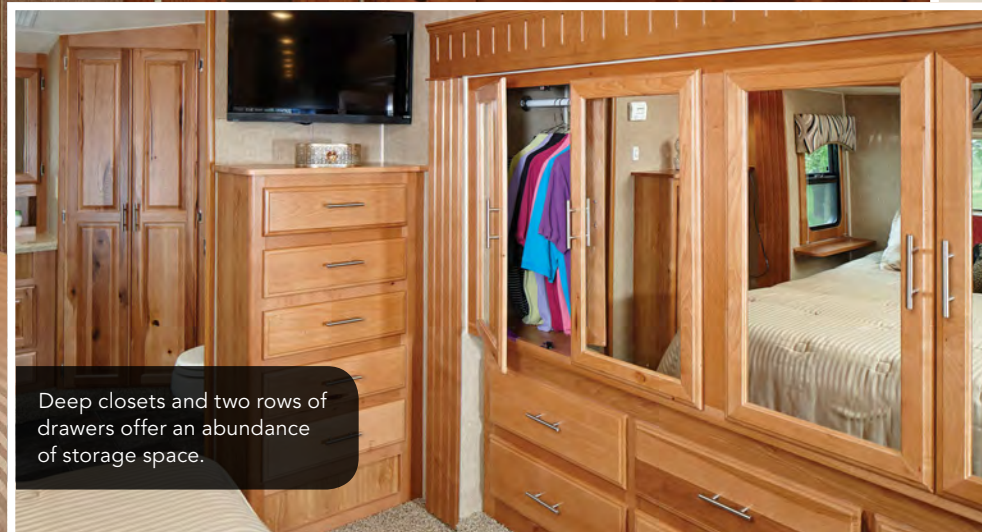

Deep closets and two rows of drawers offer an abundance of storage space.

LIMITED



Optional glazed maple woodwork creates a luxurious feel.

THE HIGHEST
LEVEL OF
LUXURY

Brimming with cutting-edge standard amenities and attractive options, Excel's luxurious Limited line represents the epitome of American ingenuity. Our 2014 models include fresh, clean lines for today's more contemporary traveler. The Limited provides the complete comfort and luxurious feel of a 5-star hotel, making it the optimal choice for the full-time and avid RVer. Its lasting quality means your Limited will serve you faithfully for many years to come.



Thoughtful storage solutions are found throughout the unit, like a pullout pantry in the kitchen. The pantry even features an electrical outlet that allows it to be used as an appliance garage. Rich hickory interior is standard in the Limited.

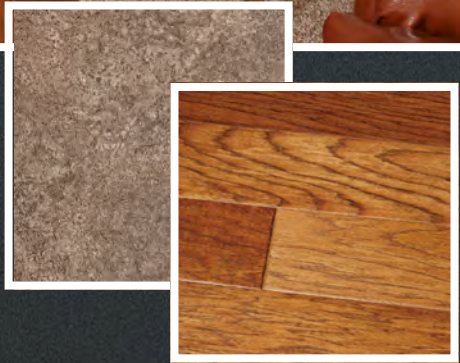

Our vinyl and hand scraped hickory flooring are easy to maintain, feel great underfoot, and are beautiful to behold.



The digital SeeLevel monitor lets you check water levels quickly and easily.

LIMITED



RKM FLOOR PLAN



Open floor plans accommodate guests in style. Optional portable island is handy when more prep space is desired.

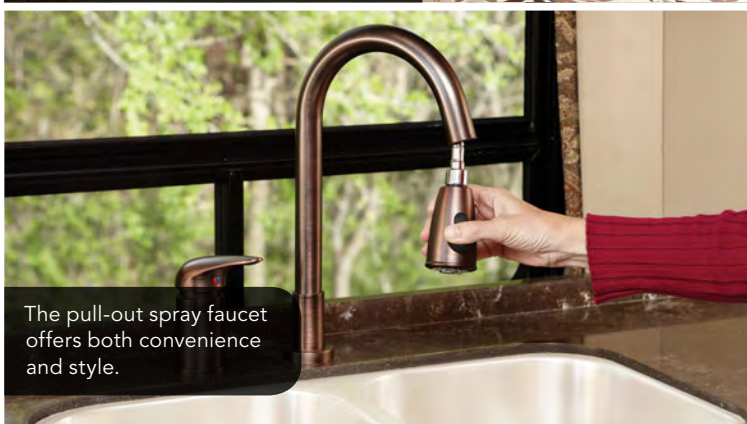

The pull-out spray faucet offers both convenience and style.



Most models feature a full backsplash behind the range to protect the wall.



The optional quad door refrigerator features 12 cubic feet of space.





The optional stainless steel package includes a residential style refrigerator with ice maker.



Features that multi-task, such as this pullout desk, reveal extra storage and easily stows away when not in use.

LIMITED



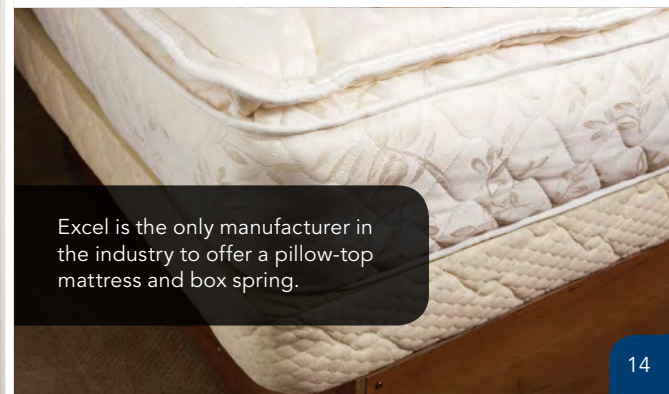

Sofas are available in a variety of different fabric combinations and feature a standard hide-a-bed with innerspring mattress.

Our optional EZ-up coffee table can be extended and used as a writing desk or an additional place setting.

Excel is the only manufacturer in the industry to offer a pillow-top mattress and box spring.



An adjustable shower head comes standard in the Limited and allows you to easily change the height and tilt.

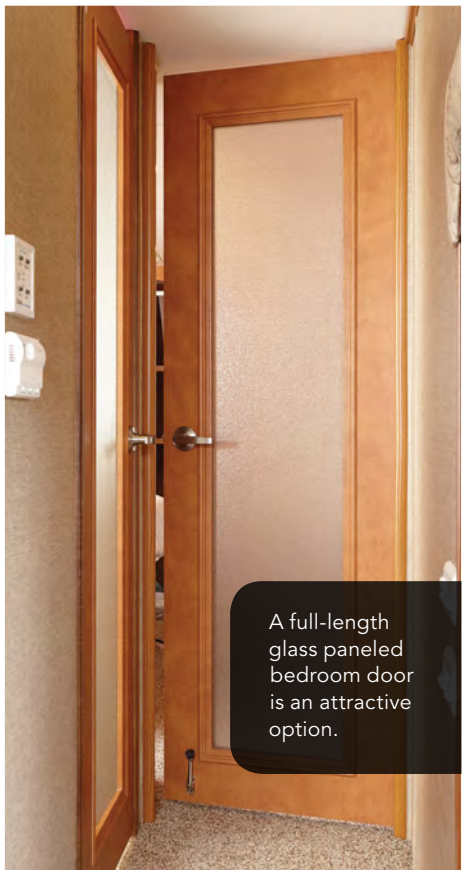

A full-length glass paneled bedroom door is an attractive option.

WILD CARGO



**ACTION
ON THE GO**

If your ideal vacation includes a motorcycle, golf cart, 4-wheeler or other off-road toys, without sacrificing the comforts of home, the Wild Cargo is perfect for you. The Wild Cargo includes features like solid surface countertops and quality-constructed furniture, which distinguishes it from other toy haulers that are built for function alone. The 10½ foot garage accommodates two motorcycles or even a Smart Car, since the ramp door is rated for 2,000 pounds. The garage can also be used as an office, patio, second bedroom, hobby or exercise room, making it perfect for extended stays or full-time use.

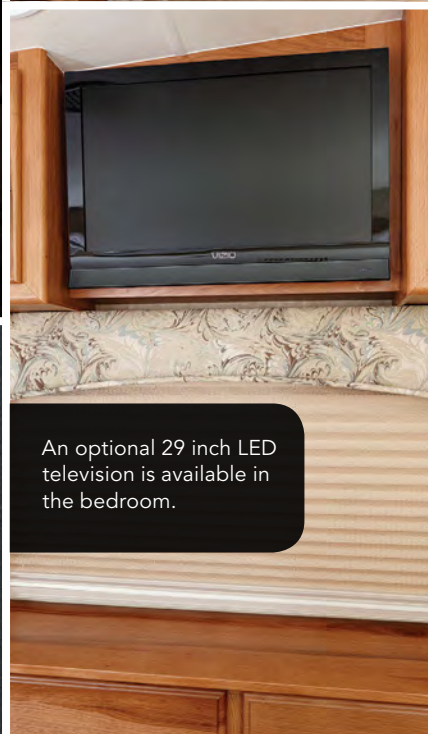

Enjoy the outdoors with our optional VIP patio deck.

An optional 29 inch LED television is available in the bedroom.

W41GKE

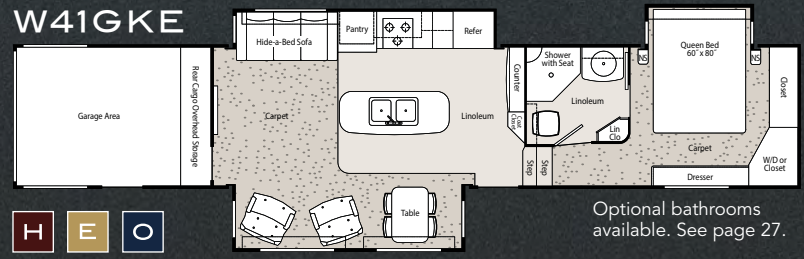

H E O

Optional bathrooms available. See page 27.

WILD CARGO



The optional sit-and-sleep benches fold down into a bed, and the bunk and benches both move up and out of the way when not in use.





An optional fuel center keeps your motorcycle or ATV gassed up and ready to go.



An easy-open aluminum framed ramp door is rated for 2000 pounds.



Our optional VIP patio deck with awning and optional patio screen offers the ultimate in outdoor living.



RV ENHANCING AMENITIES AND OPTIONS

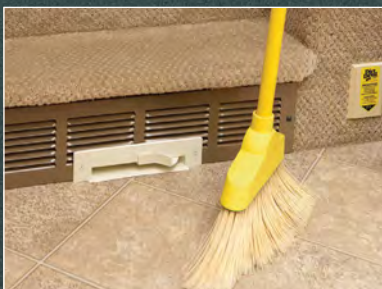

The central vac with powerhead and VacPan makes cleaning a breeze!

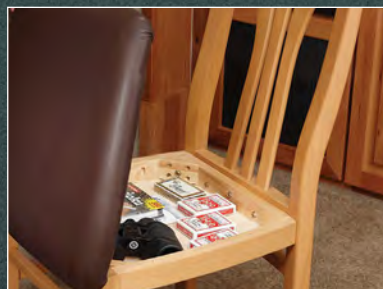

Maximized storage is part of every floor plan, including this under-seat compartment on all the dining chairs.



We offer an optional dinette booth in many models.



Your pets will appreciate an easy to access feeding station located below the shower in some models. Push it in when not in use.



Stainless steel appliances are included with the optional Residential Refrigerator Package (N/A separately).

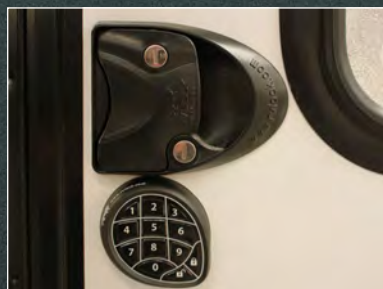

The keyless locking system offers effortless programming and a secure, convenient way to safeguard your RV.



Enhance your digital entertainment experience with an automatic satellite system for DISH Network or DIRECTV.



With our motorhome style fully automatic leveling system, just push the "Automatic Level" button and watch it work!



Pivot-EZ sewer hose compartment ensures you'll never have to disconnect your hose from the RV.



The Glide Ride Pin Box absorbs bumps and jolts through a gravity, self-centering parallel linkage system.



Storage space for lawn chairs makes sitting around a campfire quick and easy.



LED exterior lights keep you visible in all kinds of weather.



Commercial grade rubberized flooring in the basement makes cleanup easy.



We also offer disc brakes without the MorRyde suspension.

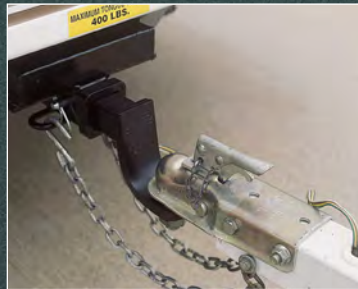

Our factory installed Class III receiver hitch is capable of pulling a 4,000lb boat or carrying up to 400lb direct weight.



Our lateral arm awning (Limited models) operates with a remote control and features a wind sensor control that will retract itself in windy conditions.



Haul your motorcycle anywhere with our frame-mounted Hydralift™. Available on models 34' and shorter.



Our uni-body hydraulic valve system for slide rooms and jacks include individual functionality and a manual override.



Our multi-function utility center provides easy access to shut off individual faucets, change water filters, replace vacuum bags, disconnect the battery and more.

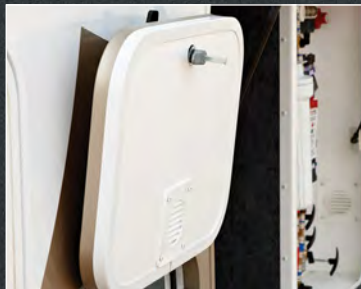

Gel-coated access doors are a full 1-3/8" thick, offering longer life, better insulation and a tight seal for protection from moisture and insects.



Electric stabilizer jacks make setting up your Winslow a breeze and saves your back and shoulders.



Rhino
VEHICLE PROTECTION™

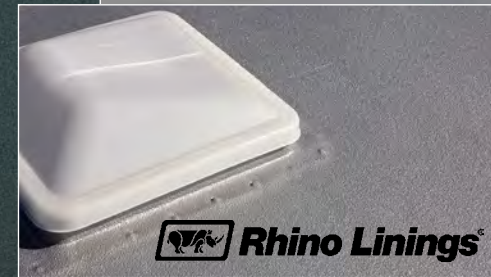

Excel RVs were in the first in the industry to offer Rhino Eco-Coat roof systems on Winslow and Wild Cargo units. This new system uses the trusted performance of Rhino truck bed lining, to protect the roof of your RV! The benefits speak for themselves:

- It's maintenance free, and far more durable than typical roofing material.
- It's 100% seamless, and can be easily patched if new equipment is added to the roof.
- This fire retardant system meets UL 790 requirements.
- Available as an option on Limited models, the slide-out roofs can also be Rhino coated.
- A limited lifetime product and application warranty eliminates worry!

Our trained service professionals can also add it to existing RVs, livestock trailers, cargo or utility trailers, too!



RV ENHANCING AMENITIES AND OPTIONS

DECORATOR PACKAGES

A variety of wood finishes, upholstery, window fabrics, and floor coverings are available for every taste – from contemporary to traditional and everything between. Every choice is designed for comfort, durability, and easy care and maintenance.

See your dealer for fabric samples and decorator package options.



Traditional-style sofa (Optional)

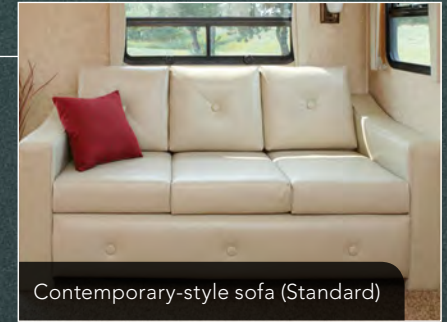

Contemporary-style sofa (Standard)

FLOORING

Vinyl flooring by Beauflor® is standard in the Winslow and Wild Cargo. Hand-scraped hickory wood laminate flooring is standard in the Limited.

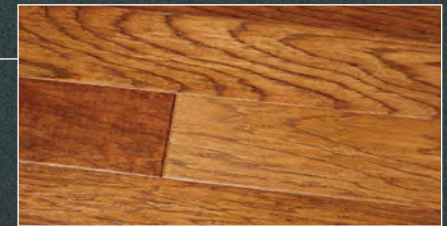

CABINETS

All Peterson Industries models are standard with the rustic feel of solid hickory cabinetry or you may also choose the upscale elegance of our new glazed maple.



VALANCES

Window valances with duplex shades can be customized to showcase your choice of fabric. All windows have wood frames for a polished look.

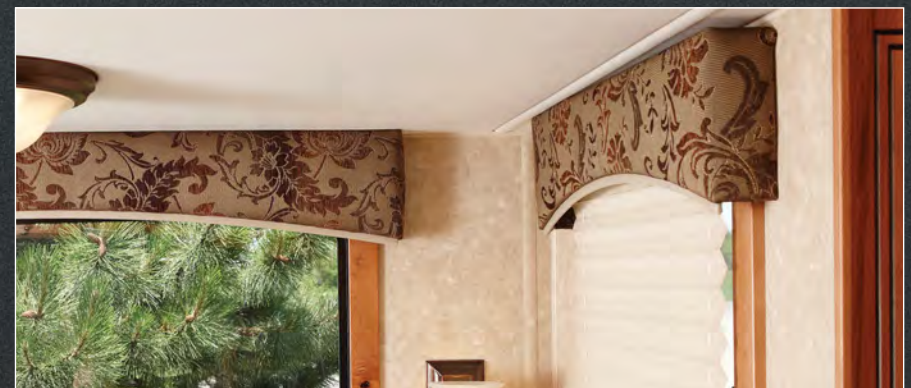

2014 OPTIONS AND STANDARD FEATURES

Each Excel model is geared to meet the expectations, needs and budgets of different RV buyers. It's not a matter of one line being "better" than another, but more a question of which line best meets your lifestyle. The chart below compares the standard and optional features of our three lines. Rest assured, however, that whether you pull a Winslow, Limited or Wild Cargo, your fifth wheel comes with one standard feature no other manufacturer can offer — the legendary value of Excell!

Construction and Exterior Features	W	L	WC
Full Body Paint	Opt	Opt	Opt
Fully Enclosed and Heated Underbelly	Std	Std	Std
Exclusive -10 Degree Freeze Guarantee	Std	Std	Std
Utility Center w/Water Manifold	Std	Std	Std
2 - 8" Exterior Scene Lights	Std	Std	Std
Manual Awning	Std	-	Std
Power Awning (w/o Wind Sensor)	Opt	-	Opt
Electric "Lateral Arm" Awning w/Wind Sensor	-	Std	-
16" Aluminum Wheels & Goodyear Tires	Std	Std	Std
Dual 30# Bottles	Std	Std	Std
Dual 40# Bottles	Opt	Opt	Opt
Gel-Coated Fiberglass Exterior, Front & Rear Cap	Std	Std	Std
Gas Struts on Access Doors	Std	Std	Std
1-3/8" Thick Radius Gel-Coated Access Doors	Std	Std	Std
"Drop Z" Box Tube Frame Construction (No I-Beam)	Std	Std	Std
Frameless Tinted Thermo-Pane Windows	Std	Std	Std
Walk Anywhere One-Piece Seamless EPDM Roof	Std	-	Std
Walk Anywhere Molded Gel-Coated Fiberglass Roof	-	Std	-
Walk Anywhere Rhino Eco-Coat Roof System	Opt	-	Opt
LED Interior Lighting	Opt	Std	Opt
LED Clearance/Tail Lights	Opt	Std	Opt
Lawn Chair Storage (Most Models)	Opt	Std	Opt
Steel Generator Box ONLY	Opt	Std	Opt
Class III Receiver Hitch (N/A in Canada)	Opt	Opt	-
NevRlube Axles and Shock Absorbers	Std	Std	Std
Disc Brakes - 17.5" "H" Tires	Opt	Opt	Opt
Mor-Ryde Susp. w/Disc Brakes - 17.5" "H" Tires	Opt	Opt	Opt
Glide Ride Pin Box	Opt	Opt	Opt
Hydralift Motorcycle Carrier (34' & Below)	Opt	Opt	-

Living/Dining Furniture and Accessories	W	L	WC
Rocker/Glider Swivel Recliners	Std	Std	Std
Hide-a-Bed in Sofa	Std	Std	Std
Sofa Caddie (N/A in Wrap-Around Sofa)	Opt	Opt	Opt
Pull Out Computer Desk (Most Models)	Opt	Std	Opt
"E-Z" Up Coffee Table	Opt	Opt	Opt
End Table Between Recliners	Opt	Opt	Opt
Solid Wood Dinette Table With Pedestal Base	Std	Std	Std
Dining Booth (Instead of Table and Chairs)	Opt	Opt	Opt

W=Winslow	L=Limited	WC=Wild Cargo
-----------	-----------	---------------

Interior Construction Details	W	L	WC
Linoleum in Bathroom, Kitchen & Entry	Std	-	Std
Quality 8 lb. Rebond Pad	Std	Std	Std
Premium Carpet	Opt	Std	Opt
Residential Laminate Wood Flooring	Opt	Std	Opt
Hickory Interior	Std	Std	Std
Glazed Maple Interior	Opt	Opt	Opt
Ball Bearing Drawer Glides w/Wood Sides (No Sawdust Board)	Std	Std	Std
Solid Wood Face Frames, Screwed Together Not Stapled	Std	Std	Std
Cedar Lined Bedroom Closet	Opt	Std	Opt
Eloquent Window Valances w/Solid Wood Casings	Std	Std	Std
MCD Ultimate MANUAL Shades	Opt	Opt	Opt
MCD Ultimate Remote Shades	Opt	Opt	Opt
Recessed Halogen Ceiling Lighting	Std	Std	Std
French Door With Full Length Glass Panel	Opt	Opt	Opt
New 6' 5" Ceilings in Level Bed and Bath Deck Area	Std	Std	Std
Padded Ceiling	Opt	Std	Opt
Solid-surface countertops w/undermount sink	Std	Std	Std
Full Decorative Backsplash in Kitchen	-	Std	-
Undermount Lavatory Sink (Incl. Cover in Ltd)	Std	Std	Std

Electrical and Misc.	W	L	WC
70 Amp Converter	Std	Std	Std
50 Amp Service	Std	Std	Std
Flush Floor New Generation Hydraulic Slide-Out System	Std	Std	Std
New Generation Hydraulic Front Jacks	-	Std	-
12V Electric Front Jacks	Std	-	Std
H&H Electric Rear Stabilizer Jacks	Opt	-	Opt
Independent Hydraulic Leveling System	Opt	Opt	Opt
Motorhome Style Fully Automatic Leveling System	Opt	Opt	Opt
Keyless Entry	Opt	Opt	Opt
Generator Ready for Onan (Incl. Box, Energy Command Monitor)	Opt	Opt	Opt
5500W LP Onan Generator (Includes Generator Ready)	Opt	Opt	Opt
High Volume Fan with Rain Sensor	Std	Std	Std
15,000 BTU Roof Air Conditioner w/Concealed Return Air	Std	Std	Std
Wired for 2nd Air Conditioner in Bedroom (31' and Above)	Std	Std	Std
Ducted 2nd Air Conditioner (15M Coleman Mach 8)	Opt	Opt	Opt
Heat Pump Instead of Air Conditioner	Opt	Opt	Opt

Bedroom/Bathroom Amenities	W	L	WC
Queen Innerspring Mattress With Comforter, Pillows, & Shams	Std	Std	Std
Pillow Top Mattress	Std	Std	Std
Box Springs Under Mattress	Opt	Std	Opt
King Size Bed (Some Models)	Opt	Opt	Opt
Nightstand on each side of the bed	Std	Std	Std
Lightblocker Vent Cover in Bedroom	Opt	Std	Opt
Lift-Up Bed for Additional Storage	Std	Std	Std
Large One-Piece Fiberglass Shower With Glass Door	Std	Std	Std
China Toilet	Std	Std	Std

Appliances and Accessories	W	L	WC
Microwave Oven	Std	-	Std
Convection Microwave Oven	Opt	Std	Opt
Recessed 3-Burner Range with Sealed Burner & Piezo Ign	Std	Std	Std
8 Cu Ft 2-Door Refrigerator	Std	-	Std
10 Cu Ft 2-Door Refrigerator	Opt	Std	Opt
12 Cu Ft 4-Door Refrigerator (N/A in all Models)	Opt	Opt	Opt
18 Cu Ft Residential Refrigerator w/Stainless Appliances and Inverter (N/A on all Models)	Opt	Opt	Opt
Cable TV Prewire & TV Antenna With Booster	Std	Std	Std
Pre-Wire Ground Based AND Roof Mount Sat	Std	Std	Std
Winegard "Trav'ler Sat System for Dish or DirecTV	Opt	Opt	Opt
19" or 29" LED TV in Bedroom (Depending on Model)	Opt	Opt	Opt
42" LCD TV in Livingroom (Most Models)	Std	Std	Std
Swing Arm Mount for LCD TV	Opt	Opt	Opt
Monitor Panel	Std	-	Std
SeeLevel Electronic Tank Monitoring System	Opt	Std	Opt
Central Vacuum System w/Powerhead and VacPan	Opt	Opt	Opt
Electric Fireplace (N/A in All Models)	Opt	Opt	Opt
Washer/Dryer Ready	Std	Std	Std
2-Piece Front Load Washer/Compact Dryer	Opt	Opt	Opt
Motorized SENSAR TV Antenna	Opt	Opt	Opt
35M BTU Furnace (except 37' & 38')	Std	-	-
40M BTU 2-Stage Furnace	Opt	Std	Std

Plumbing	W	L	WC
Actively Heated Holding Tanks, Water Tank, Valves, Water Lines	Std	Std	Std
16 Gallon Output Gas/Electric DSI Water Heater With Bypass	Std	Std	Std
Whole House Water Filtration System	Opt	Std	Opt
ShurFlo High Volume Demand Water Pump	Std	Std	Std
Pivot-EZ Sewer Hose Comp. w/20' Hose	Opt	Opt	Opt

WINSLOW	MODEL:	28RKW	31IKE	31RLE	31RSE	34IKE	34IKR	34RLE	34SKE	37FLE	37IKE	37IKF	37RKM	37SDF	38RDE	WINSLOW TT			
	Base Unit Wt. (W/O Opt.)	11,600	12,600	12,280	11,900	13,280	13,180	13,160	13,160	14,450	13,800	14,600	14,490	15,020	14,800		11,550	11,500	11,880
	Unloaded Vehicle Wt. (W/O Water)	11,900	12900	12580	12200	13,580	13,480	13,460	13,460	14,750	14,100	14,900	14,790	15,320	15,100		11,850	11,800	12,180
	Hitch Weight (W/O Water)	2,500	2690	2570	2560	2,540	2,640	2,380	2,380	2,750	2,750	2,750	2,640	2,800	2,920		1,150	1,100	1,080
	Weight on Axles	9,400	10,210	10,010	9,640	11,040	10,840	11,080	11,080	12,000	11,350	12,150	12,150	12,520	12,060		10,700	10,700	11,100
	Combined Axle Weight Rating	12,000	14000	14000	14000	14,000	14,000	14,000	14,000	15,000	15,000	15,000	15,000	15,000	15,000		14,000	14,000	14,000
	Payload Capacity	3,100	4,600	4,920	5,300	3,920	4,020	4,040	4,040	4,000	4,650	3,850	3,960	3,430	3,770		3,650	3,700	3,320
	Maximum GVWR	15,000	17,500	17,500	17,500	17,500	17,500	17,500	17,500	18,750	18,750	18,750	18,750	18,750	18,750		15,500	15,500	15,500
	Height (Incl Vents & A/C)	151"	151"	151"	151"	151"	151"	151"	151"	151"	151"	151"	151"	151"	151"		143"	143"	143"
	Overall Length (Pin to Bumper)	29' 5"	32' 11"	32' 11"	32' 11"	35' 7"	35' 5"	35' 5"	35' 5"	38' 9"	37' 2"	38' 9"	38' 2"	38' 9"	39' 8"		34' 3"	34' 3"	34' 3"
	Square Feet	309.5	341.0	341.0	341.0	356.5	356.5	356.5	356.5	377.0	390.1	400.0	394.7	406.0	410.0		331.0	331.0	331.0
	Fresh Water Capacity (Incl WH)	71	88	88	88	88	88	88	88	88	88	88	88	88	88		64	64	64
	Gray Water Capacity	55	67	67	67	67	67	67	67	44	67	67	67	67	67		67	67	67
	Black Water Capacity	40	44	44	44	44	44	44	44	44	44	44	44	44	44		44	44	44
	In-Line Central Air	15M	15M	15M	15M	15M	15M	15M	15M	15M	15M	15M	15M	15M	15M		15M	15M	15M
	Furnace BTU	35M	35M	35M	35M	35M	35M	35M	35M	40M	40M	40M	40M	40M	40M		35M	35M	35M
Bedroom Interior Height	6' 5"	6' 5"	6' 5"	6' 5"	6' 5"	6' 5"	6' 5"	6' 5"	7' 6"	6' 5"	7' 6"	6' 5"	6' 5"	6' 5"		6' 10"	6' 10"	6' 10"	
2 Pc. Stacking Washer/Dryer	N/A	OPT	OPT	OPT	OPT	OPT	OPT	OPT	OPT	OPT	OPT	OPT	OPT	OPT		N/A	N/A	N/A	
Electric Fireplace	N/A	OPT	OPT	OPT	OPT	OPT	OPT	OPT	OPT	OPT	OPT	OPT	OPT	OPT		OPT	OPT	OPT	
Awning Size	14'	16'	16'	16'	17'	17'	17'	16'	17'	17'	17'	17'	16'	17'		15'	15'	15'	

LIMITED	MODEL:	31IKE	31RLE	31RSE	34IKE	34IKR	34RLE	34SKE	36GKE	36GKM	36RKM	38RDE	WILD CARGO		
	Base Unit Wt. (W/O Opt.)	12,600	12,600	12,180	13,890	13,500	13,680	13,680	14,490	14,500	14,100	14,680		W41GKE	15,900
	Unloaded Vehicle Wt. (W/O Water)	12,900	12,900	12,480	14,190	13,800	13,980	13,980	14,790	14,800	14,400	15,400			16200
	Hitch Weight (W/O Water)	2,880	2,740	2,700	2,730	2,720	2,760	2,760	2,850	2,790	2,790	3,100			2900
	Weight on Axles	10,020	10,160	9,780	11,460	10,960	11,220	11,220	11,940	12,010	11,610	12,060			13,300
	Combined Axle Weight Rating	14,000	14,000	14,000	14,000	14,000	14,000	14,000	15,000	15,000	15,000	15,000			21000
	Payload Capacity	4,600	4,600	5,020	3,310	3,700	3,520	3,520	3,960	3,950	4,350	3,770			4,800
	Maximum GVWR	17,500	17,500	17,500	17,500	17,500	17,500	17,500	18,750	18,750	18,750	18,750			21,000
	Height (Incl Vents & A/C)	151"	151"	151"	151"	151"	151"	151"	151"	151"	151"	151"			153"
	Overall Length (Pin to Bumper)	32' 11"	32' 11"	32' 11"	35' 5"	34' 4"	34' 4"	34' 4"	37' 5"	37' 2"	38' 2"	39' 2"			42' 11"
	Square Feet	341.0	341.0	341.0	364.0	368.9	367.0	367.0	388.7	390.1	394.7	410.0			424.0
	Fresh Water Capacity (Incl WH)	88	88	88	88	88	88	88	88	88	88	88			10' 6"
	Gray Water Capacity	67	67	67	67	67	67	67	67	67	67	67			88
	Black Water Capacity	44	44	44	44	44	44	44	44	44	44	44			67
	In-Line Central Air	15M	15M	15M	15M	15M	15M	15M	15M	15M	15M	15M			44
	Furnace BTU	40M	40M	40M	40M	40M	40M	40M	40M	40M	40M	40M			15M
Bedroom Int. Height	6' 5"	6' 5"	6' 5"	6' 5"	6' 5"	6' 5"	6' 5"	6' 5"	6' 5"	6' 5"	6' 5"			40M	
2 Pc. Stacking Washer/Dryer	OPT	OPT	OPT	OPT	OPT	OPT	OPT	OPT	OPT	OPT	OPT			8' 3 1/2"	
Electric Fireplace	OPT	OPT	OPT	OPT	OPT	OPT	OPT	OPT	OPT	OPT	OPT			6' 5"	
Awning Size	16'	16'	16'	17'	17'	17'	16'	16'	16'	16'	17'			OPT	
Electric Fireplace	OPT	OPT	OPT	OPT	OPT	OPT	OPT	OPT	OPT	OPT	OPT			OPT	
Awning Size	16'	16'	16'	16'	16'	16'	16'	16'	16'	16'	17'			16'	

NOTE: Pin to Bumper length is critical length for double towing length calculation. For specific overall unit length requirements, i.e. to fit into a building, add 24" to accommodate rear ladder and aerodynamic front cap.

FLOOR PLANS: WINSLOW ONLY

The plans featured here are only available in Winslow units. Turn the page for floor plans that apply to both the Winslow and Limited.

D28RKW

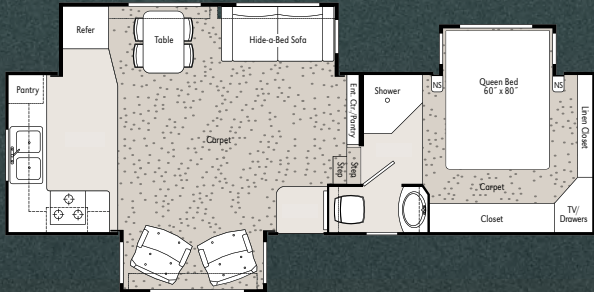

D37IKF

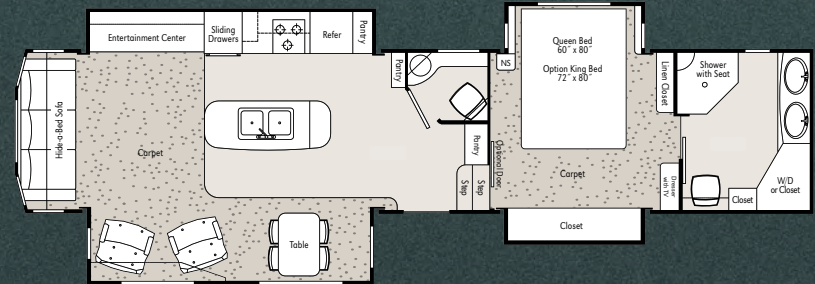

D37FLE

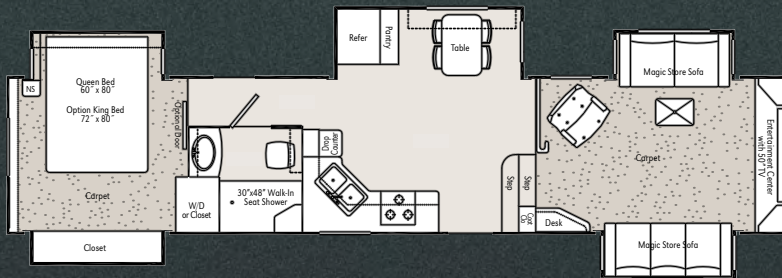

D37RKM

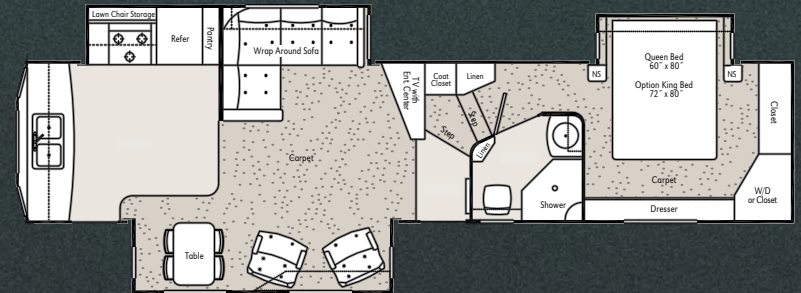

D37IKE

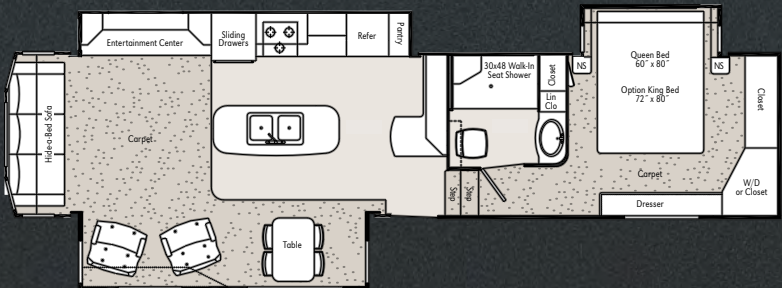

D37SDF

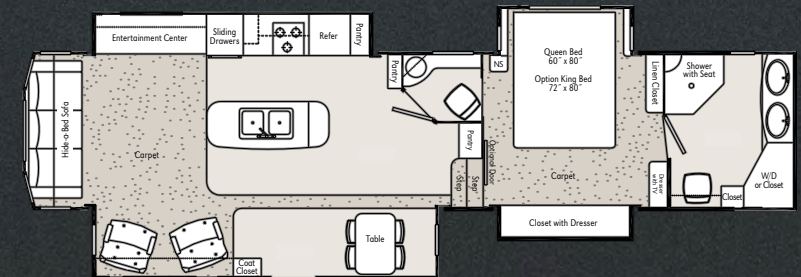

FLOOR PLANS: WINSLOW & LIMITED

Any of the floor plans featured here are available in Winslow and/or Limited models.

31IKE

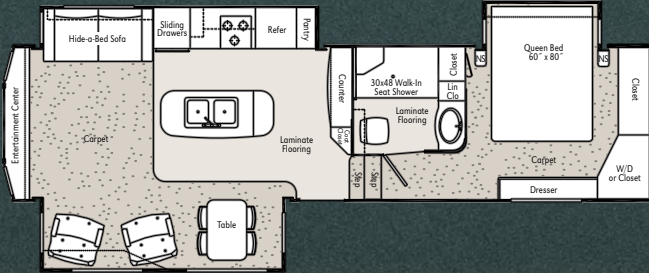

34IKE

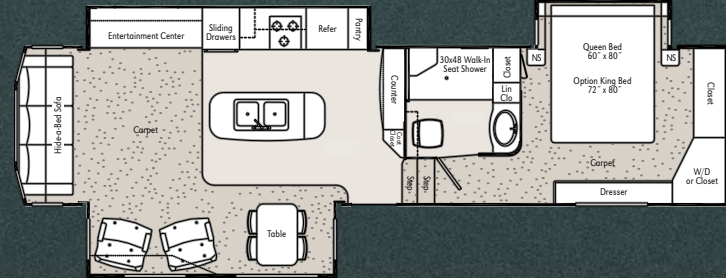

31RSE



34IKR

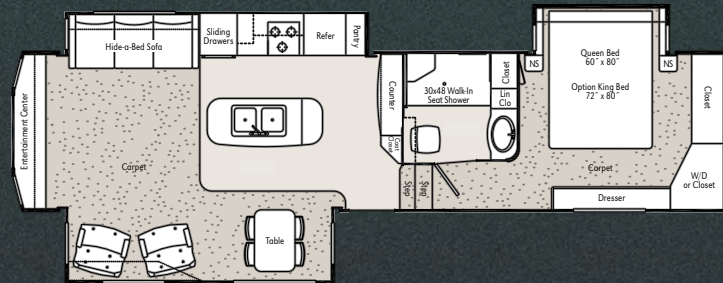

34RLE

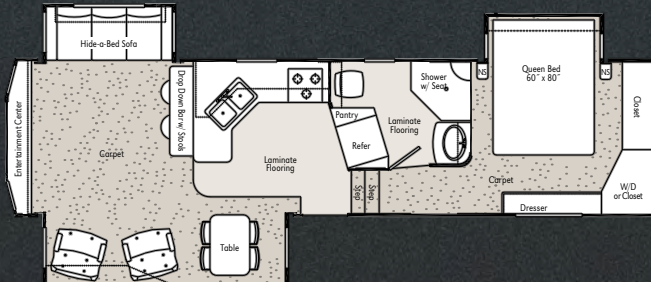

38RDE

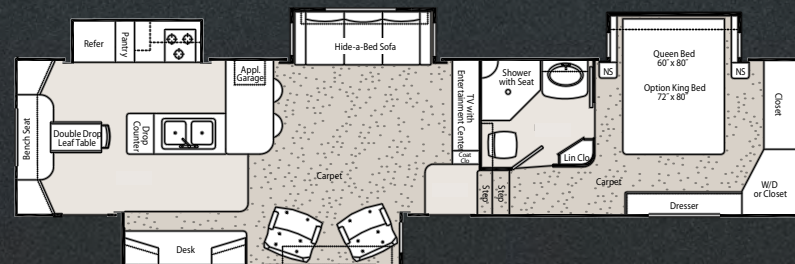

LIMITED ONLY

The plans featured here are only available in Limited units.

31RLE

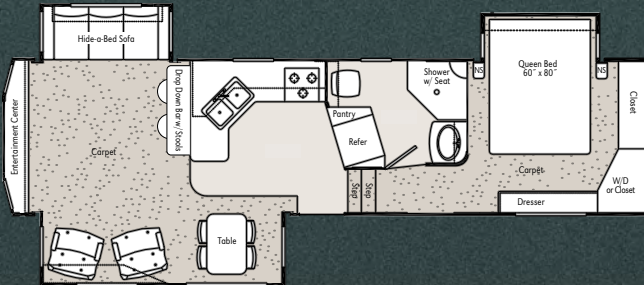

L36GKE

H E O

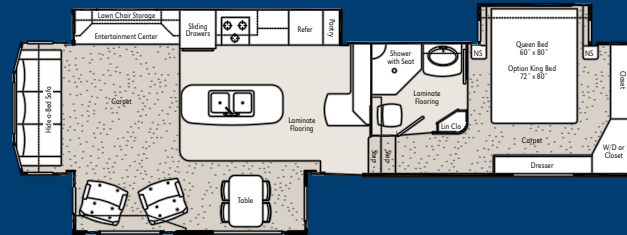

L36GKM

H E W O

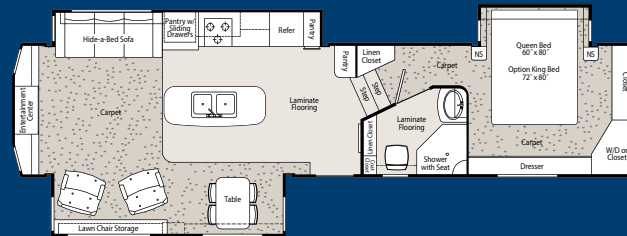

L36RKM

H E W O

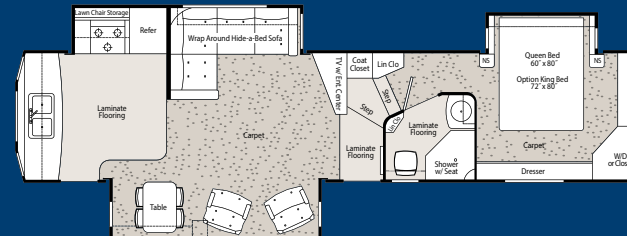

34SKE

E W O

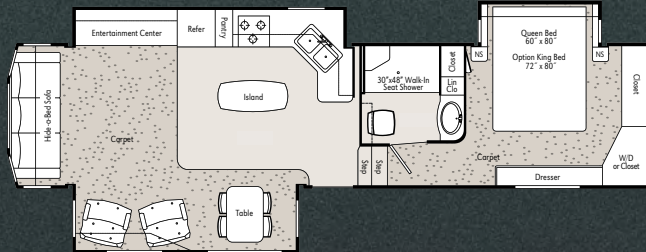

The **Winslow** is perfect for the adventurous traveler, with luxurious amenities like rich, hickory woodwork, and the groundbreaking "Drop-Z" box tube frame that provides more than 100 cubic feet of basement storage.

The **Limited** features a long list of standard luxury features beautiful laminate flooring, premium carpet, and a cedar lined closet. Special touches like the beautiful kitchen backsplash, convection microwave oven, and a pillow top mattress with box spring make the Limited feel like a luxurious home, regardless of where you are.

BATHROOM OPTIONS

When choosing an optional bathroom, additional charges apply.

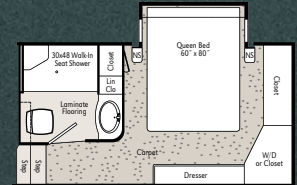

H HOME SHOWER

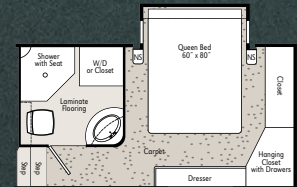

E ENCLOSED BATH

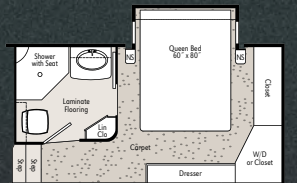

W WALK THROUGH ENCLOSED BATH

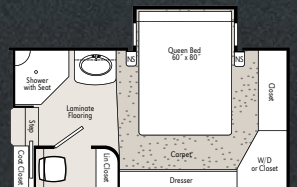

O OPEN BATH



Manufactured by Peterson Industries, Inc.
616 E. Hwy. 36, Smith Center, Kansas 66967
800-368-3759 • www.excelrvs.com

VISIT US ONLINE!

EXCELRVS.COM

Visit our website for in-depth information on our entire line of Excel RVs, including exterior views and floor plans with complete specs. You'll find model and feature photos, and so much more!

- Videos of models and features
- Model comparison feature
- Maintenance tips
- Pricing calculator
- Dealer locator
- Testimonials
- Sign up for our newsletter!

