

*Journeyer*





*Enjoying the Journey.....*



**SERVICE, PARTS & WARRANTY BUILDING**



**PLANT TWO**



**MAIN HEADQUARTERS- PLANT ONE**

# *On a Mission*

At Open Range RV, we are on a mission to...

Fulfill the trailer needs of our dealer base and retail customers, and in doing so, exceed their expectations for service, quality and value.

Earn our dealers', retail customers' and employees' long-term loyalty by delivering more than we promise, in a fair and honest business manner.

Motivate our employees to provide exceptional service and quality to our retail customers and dealers.

Compensate our employees fairly and provide opportunity for personal growth within our company.

Although it is our goal to provide a product that exceeds our customer needs and level of quality, we do not strive to be the biggest or the most profitable. In the end, we believe satisfied customers, dealers and employees will bring growth and long term profitability for all.

For almost 30 years, I have had the great fortune to work in the amazing industry of RV manufacturing. This industry runs through my blood and is the passion of my life. This has been a dream come true for me and my family. I would like to thank everyone who believed in us as an RV Manufacturer. At Open Range our motto is ENJOY THE JOURNEY!

It has been an amazing JOURNEY so far! Come join us on this great JOURNEY, we don't want you to miss another moment of it.

Enjoy the Journey!

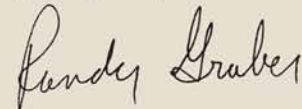
A handwritten signature in black ink that reads "Randy Graber". The signature is written in a cursive, flowing style.

Randy Graber, President  
Open Range RV Company

# *Journeyer*



Model JT340FLR Bedroom in Sedonna Decor

**FULL EXTENSION STAINLESS STEEL  
BALL BEARING DRAWER GUIDES**



**RADIUS BED BASE WITH  
TONS OF STORAGE**

**WASHER DRYER PREP**  
(Most Models)



- Easy Lift Strut Assist
- Radius Base for Easy "Walk Around"
- Full Depth Base to Fit all Your Items





**PULL OUT WASTE BASKET**



**FULL EXTENSION STAINLESS STEEL BALL BEARING DRAWER GUIDES**



**CORIAN COUNTERTOPS  
WITH FLUSH MOUNTED SINK COVERS**



- Durable Finish for Years of Use
- Nonporous Surface - Easy to Clean
- Easy Repair if Damaged
- Stainless Steel Sink
- Single Lever Pullout Spray Faucet

Model JT340FLR Kitchen in Sedona Decor

# Journeyer Floorplans



JT337RLS



JT340FLR



JT359FKS

	GVWR	UVW	Hitch Wt.	Axle Wt.	Gross NCC	Ext. Length	Ext. Height	Ext. Width	Water Heater Gas/Elec	Fresh Water	Gray Water	Waste	LP Gas (Lbs)	Furnace (BTU's)	Tire Size	Awning Size
JT337RLS	11180	7840	780	7060	3340	36'	145"	100"	10 Gal	85	57	41	60	35,000	16"	16'
JT340FLR	13455	9030	1455	7575	4425	36'	145"	100"	10 Gal	85	57	41	80	35,000	16"	16'
JT359FKS	13410	9385	1410	7975	4025	38'	145"	100"	10 Gal	85	82	41	80	35,000	16"	19'

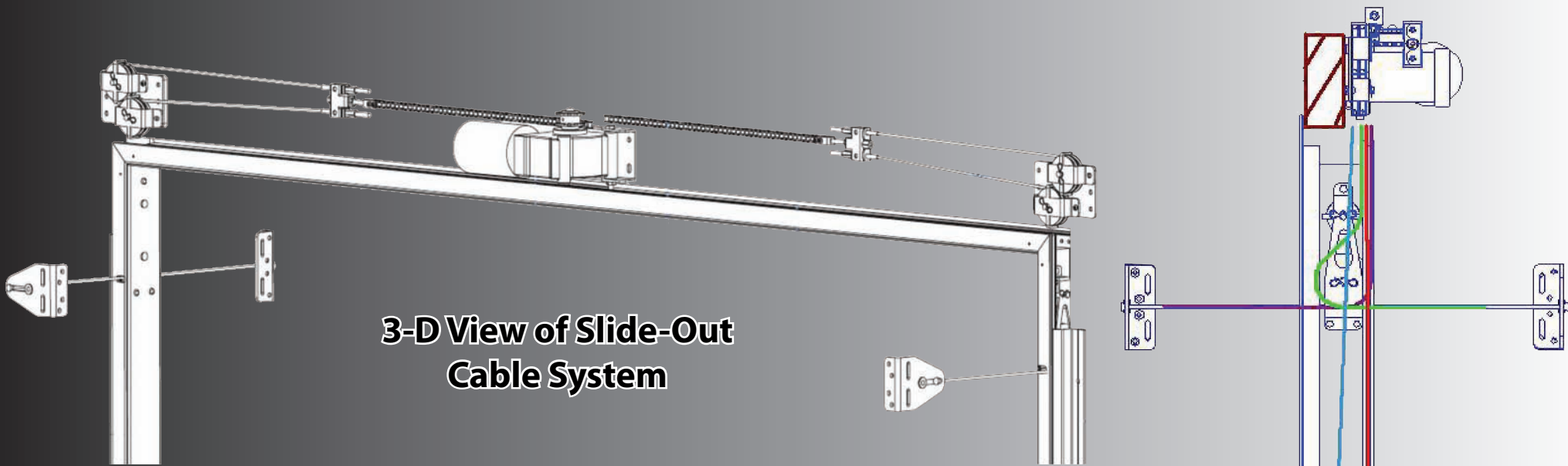

**3-D View of Slide-Out  
Cable System**

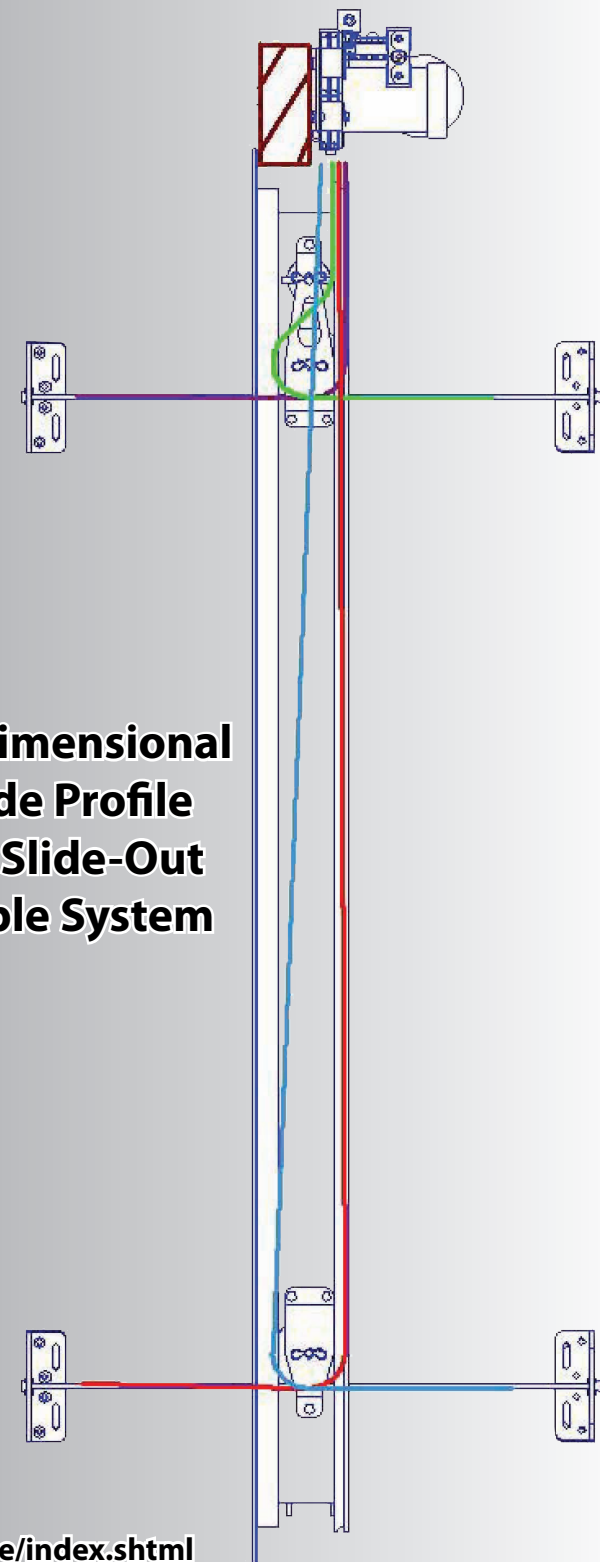

**1- Dimensional  
Side Profile  
Of Slide-Out  
Cable System**

## 10 Reasons Why... Accu-Slide

1. Above floor design means more storage area for your RV
2. Lightweight design promotes fuel savings
3. High strength stainless steel aircraft cable is used for control
4. Cable control at all 4 room corners helps stop leaks
5. Working components are in your RV, safe from the elements
6. Locking motor secures room in or out to help stop leaks
7. Above floor design minimizes maintenance requirements
8. A clean system - no leaky hydraulic lines or greasy drives
9. Smooth, quiet room movement - no jumping or jerking
10. It's built in the U.S.A. and backed by BAL since 1972



# Construction Cutaway

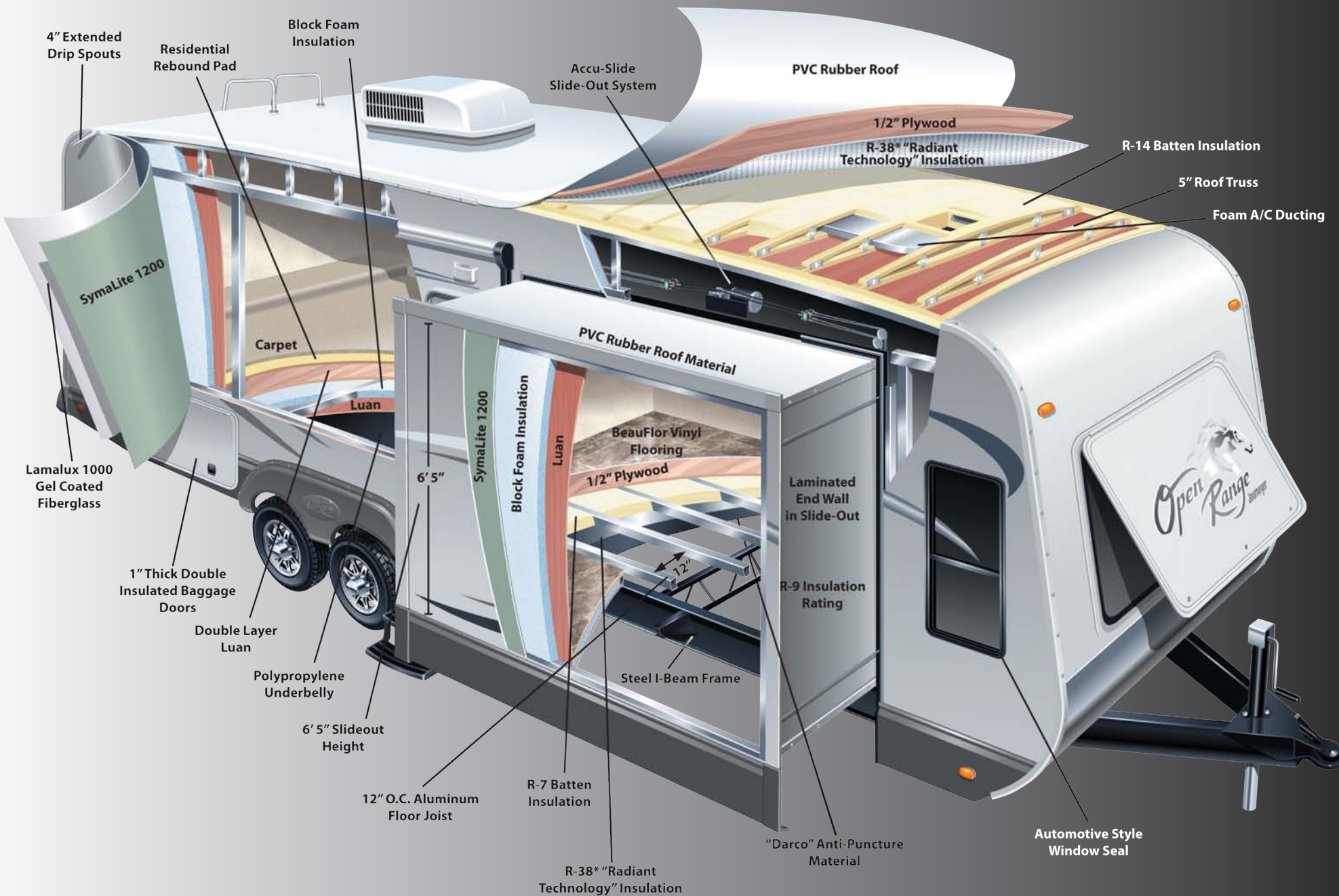

# Interior Construction

## 100 LB. FULL EXTENSION DRAWER GUIDES



## CABINET CONSTRUCTION



- Face Frames are Tube Drilled and Screwed for Maximum Strength

## HARDWOOD CABINET CONSTRUCTION



- Hardwood Cabinet Door Frames & Drawer Faces
- Lumber Core Stiles
- Mortis & Tenon Joints
- Residential Style Hidden Hinges

## 7-LAYER BEAUFLOOR VINYL FLOORING

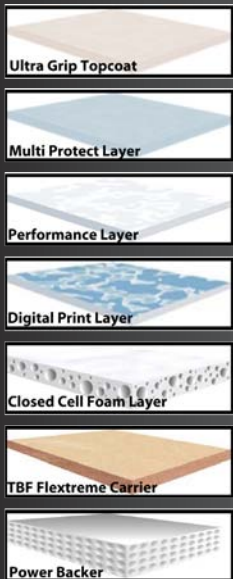

## MORTIS & TENON CABINET CONSTRUCTION



## HIDDEN HINGES



- Elegant Euro-Style Spring Loaded Hardware
- Keeps Doors Closed Tightly
- Fully Adjustable to Customize Fit

# Exterior Construction

## *1/2" PLYWOOD ROOF DECKING*

- 1/2" Thick Plywood
- 350 lb. Rating
- Constructed with Real Plywood
- More Durable
- Better Quality



## *PVC RUBBER ROOF MATERIAL*

- Ultra Violet Resistant
- No Streaking or Chalking
- No Reconditioning Needed
- 30% Lighter Weight Than EPDM Rubber Roof
- Self Extinguishing
- Can be Recycled



## *SYMALITE 1200 SIDEWALL SUBSTRATE*

- Man-Made Composite Technology
- 125% More Puncture Proof
- Additional Insulator
- Noise Reduction
- Moisture, Mold, & Swell Resistant
- Provides the Best Possible Bond with Fiberglass

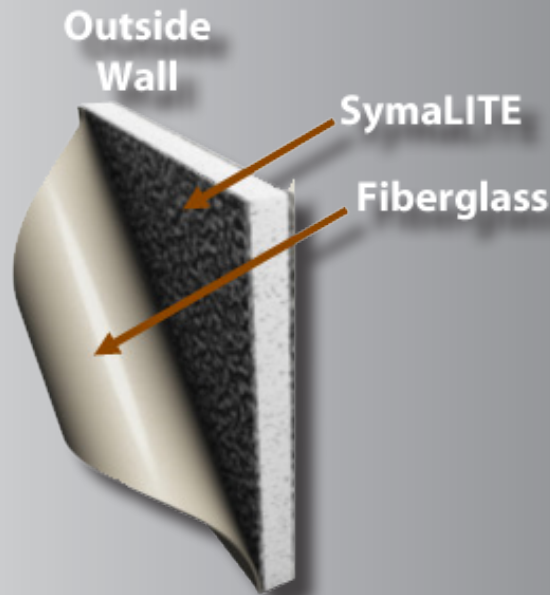

- At 30% Compression the PVC Foam Seal is 100% Waterproof
- Permanent Seal that Won't Deteriorate
- Provides a complete and Consistent Seal Throughout

## *PVC FOAM SEALS*



# Exterior Features

**Carefree**  
Power Awning

**MAXAIR**  
15,000 BTU A/C

"Fantastic Fan"

15,000 BTU A/C

4" Extended  
Drip Spouts



Pass-Thru Storage



80 Lb. LP Storage  
(N/A JT337RLS)

Compression Latch  
Baggage Doors



Dexter EZ-Flex  
Suspension



Lock Arm  
Stabilizers  
(Optional)

Stabilizing  
Jacks

"Rock Guard"

Full View Vented  
Entrance Door



# Four Seasons Protection Package



- Atwood High Performance Furnace
- Heated Storage Area
- Insulated Slide Floors
- Vented Attic
- Double Insulated Baggage Doors
- Digital Thermostat
- Heated Underbelly
- Heated and Enclosed Dump Valves
- R-38 Roof Insulation\*
- R-38 Floor Insulation\*
- R-9 Sidewalls

**JOURNEYER HEATING DIAGRAM**

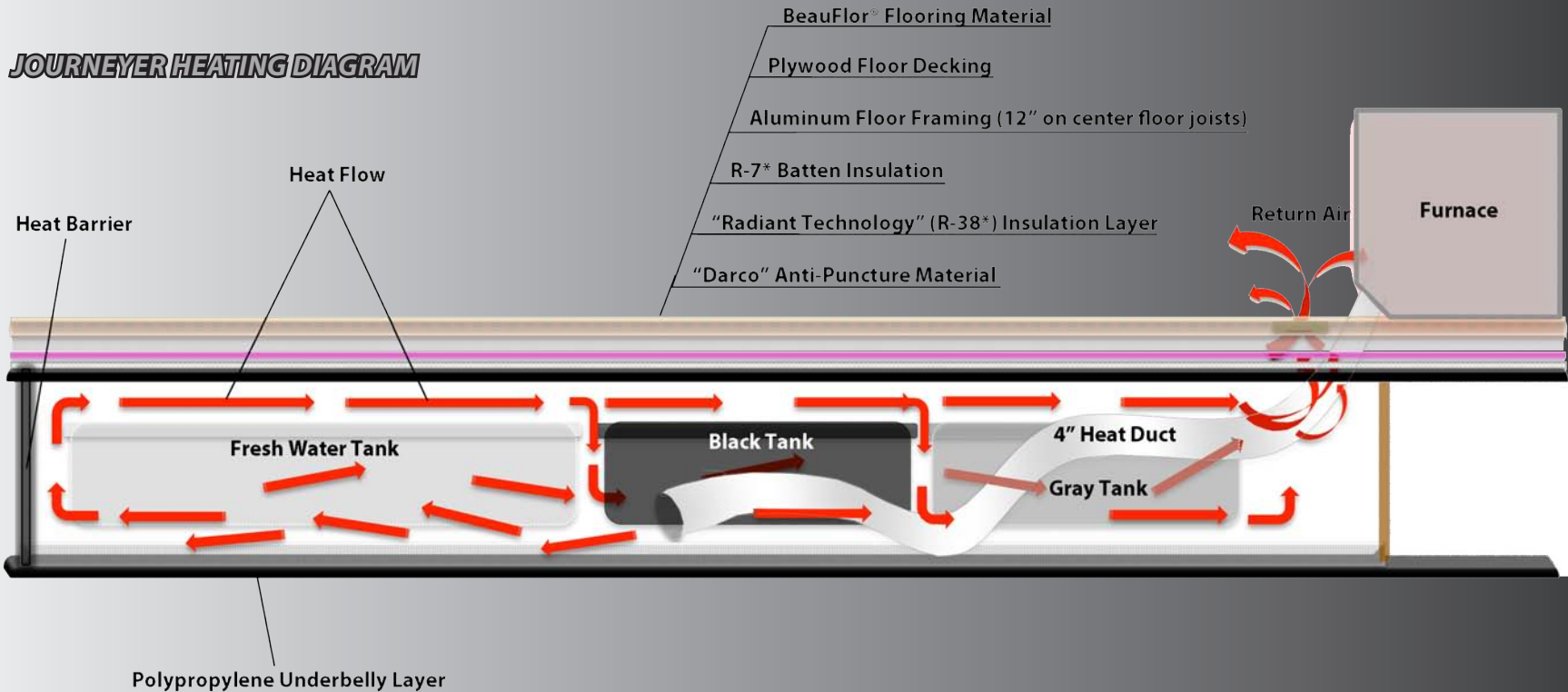

\*Calculated

# Executive Package

## Interior:

- Flat Screen TV in Living Area
- 12V CD/DVD/MP3/AM/FM/iPod® Stereo
- Large 8 cu ft Refrigerator
- Corian® Countertops
- "Comfort Cloud" Pillowtop Mattress
- Fantastic Fan in Kitchen
- Concealed Hinges
- Knotty Alderwood Cabinet Doors
- LED Lighting in Ceiling
- Crown Molding

## Interior cont...

- EZ Access Entry Light
- Wired and Framed for 2nd A/C in Bedroom
- **Exterior**
- Multi-Port Satellite Hook-Up
- Digital TV Antenna w/ Booster
- 10 Gal Gas/Elec Quick Recovery Water Heater
- 15,000 BTU A/C w/ "Quick Cool" Feature
- Carefree of Colorado Power Awning
- "Maxx Air" Vent Cover
- Removable Rear Ladder
- Full View Vented Entrance Door

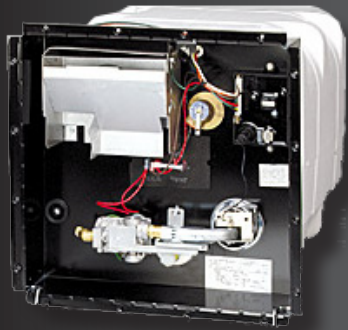

Equipped with  
**JACK® DIGITAL  
HDTV ANTENNA**  
with Integrated SureLock  
TV Signal Meter!

- \* No need to crank up or down and is always ready for travel
- \* Built-in signal meter for fast and accurate antenna pointing
- \* Full 360° rotation allows for precise antenna pointing with no "dead spot"

A PRODUCT OF  
**IKG KING  
CONTROLS**

# Journeyer Decors

Sofa Solid



## Lifelong



Sofa Solid



## Sedonna



Sofa Solid

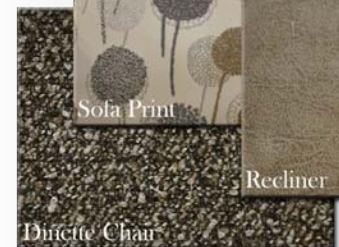

## Pinto



## Interior Standards

- High Output Range w/Igniter and Large 22" Oven
- Heavy Duty Full Extension Drawer Guides
- Large Lavatory Sink
- Porcelain Toilet w/ Foot Pedal Flush
- French Door to Bedroom

**TWO-YEAR LIMITED  
TRANSFERABLE WARRANTY**

## Exterior Standards

- Exterior Utility Center w/ Black Tank Flush
- Dexter EZ Lube Axles
- EZ Flex Suspension
- Front and Rear Stabilizer Jacks
- LP Quick Connect
- 80lbs of LP Capacity (Most Models)
- 100" Wide Body w/ Wide Stance Axles
- PVC Rubber Roof
- Nitrogen Filled Radial Tires
- 50 Amp Service



# OPEN RANGE

Open Range RV Company 3195 N. St. Rd. 5 Shipshewana, IN 46565

Phone: (260) 768-7771 - [www.OpenRangeRV.com](http://www.OpenRangeRV.com)

Due to continual research and advances, manufacturer reserves the right to change specifications, design, price, and equipment without notice, and assumes no responsibility for any error in the literature. Some items shown are not included as standard or optional equipment

©2012 Open Range RV Company, Shipshewana, Indiana  
Published: May 1<sup>st</sup>, 2012

## **PURCHASE LOCALLY**

Open Range RV strongly encourages our retail customers to purchase from their local dealership whenever possible due to the following reasons:

**1)** Our Dealers are as a rule, independently owned and operated businesses. Outside of those customers they personally sold products to, they are not obligated to perform warranty service on Open Range RV products that were purchased elsewhere. There may be an occasion that the customer will be required to return to the point of purchase to satisfy warranty requirements.

**2)** Although many dealerships will eventually service products not purchased at their dealership, they will usually take care of their customers and other Open Range RV customers who are traveling away from their local dealer as a priority.

**3)** Local purchases allow a customer to establish a relationship with a dealer close to home. This relationship provides the customer with a convenient location for service and support from a "local" professional.

**4)** The opportunity for a thorough PDI (Pre Delivery Inspection) and product orientation is an additional benefit of buying from a local dealer. The opportunity for refresher courses or the ability to get questions answered more promptly is another additional benefit of buying from a local dealer.

**5)** For our Canadian customers, there are also requirements which must be met to bring an RV purchased out of the country to their home. Although not impossible, these requirements may involve such things as additional inspections, certifications, taxes and fees. The local Canadian Dealer is a professional at meeting these requirements.

**6)** Open Range's goal is for all RV Owners to fully enjoy their RV experience. In light of this goal, and considering the advantages of buying locally, we encourage you to be thorough when determining what product to purchase and which dealer to purchase it from as both are key to your ultimate satisfaction.

**Your Open Range Dealer:**