



Light

By *Open Range*



*Enjoying the Journey.....*



**SERVICE, PARTS & WARRANTY BUILDING**



**PLANT TWO**



**MAIN HEADQUARTERS/PLANT ONE**

# On a Mission

At Open Range RV, we are on a mission to...

Fulfill the trailer needs of our dealer base and retail customers, and in doing so, exceed their expectations for service, quality and value.

Earn our dealers', retail customers' and employees' long-term loyalty by delivering more than we promise, in a fair and honest business manner.

Motivate our employees to provide exceptional service and quality to our retail customers and dealers.

Compensate our employees fairly and provide opportunity for personal growth within our company.

Although it is our goal to provide a product that exceeds our customer needs and level of quality, we do not strive to be the biggest or the most profitable. In the end, we believe satisfied customers, dealers and employees will bring growth and long term profitability for all.

For almost 30 years, I have had the great fortune to work in the amazing industry of RV manufacturing. This industry runs through my blood and is the passion of my life. This has been a dream come true for me and my family. I would like to thank everyone who believed in us as an RV Manufacturer. At Open Range our motto is ENJOY THE JOURNEY!

It has been an amazing JOURNEY so far! Come join us on this great JOURNEY, we don't want you to miss another moment of it.

Enjoy the Journey!

A handwritten signature in black ink that reads "Randy Graber". The signature is written in a cursive, flowing style.

Randy Graber, President  
Open Range RV Company

# Light



Model LF297RLS in Bloom Decor



### ***DEEP POTS & PANS DRAWER***

- Conveniently Placed Under Kitchen Stove
- Extra-Deep to Fit All Your Pots & Pans
- Ball Bearing Guides for Easy Access



Model LF297RLS in Bloom Decor

**WASHER/DRYER PREP**  
(Most FW Floorplans)



Model LF297RLS Bedroom in Bloom Decor



LF297RLS Side Isle Bath

***RADIUS BED BASE WITH  
TONS OF STORAGE***

- Easy Lift Strut Assist
- Radius Base for Easy "Walk Around"
- Full Depth Base to Fit All Your Items



# Fifth Wheel Floorplans

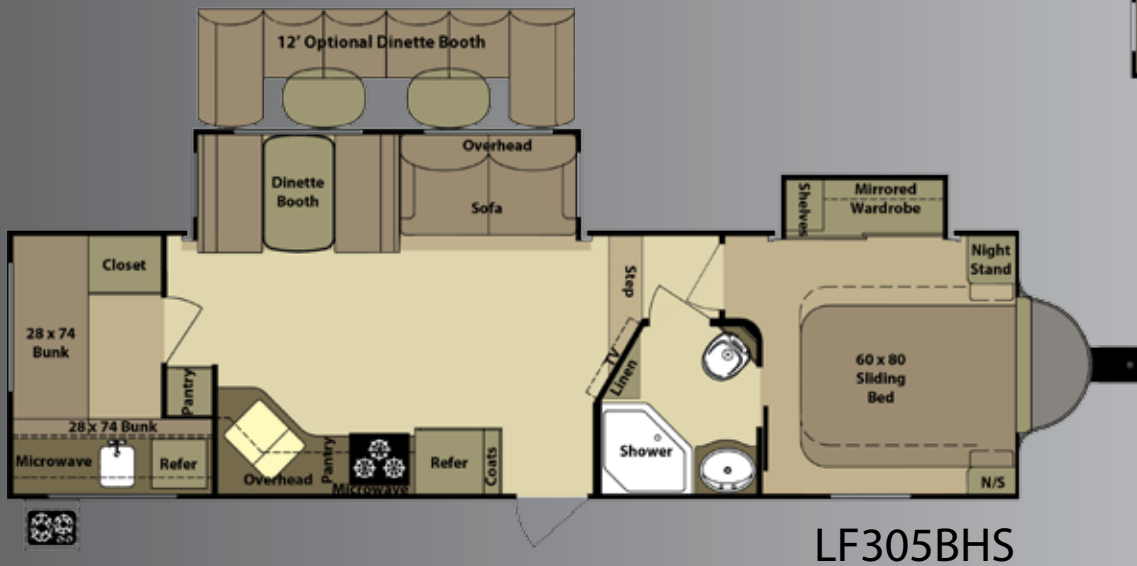
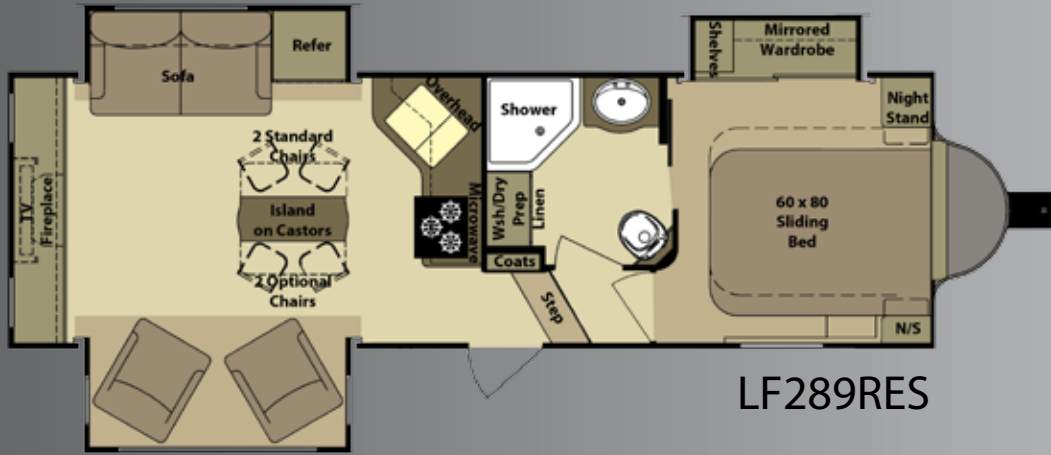

# Travel Trailer Floorplans

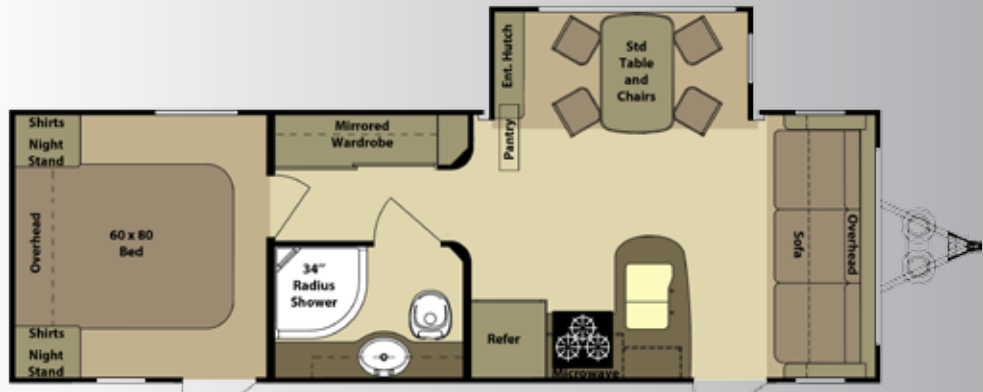

LT252FLR

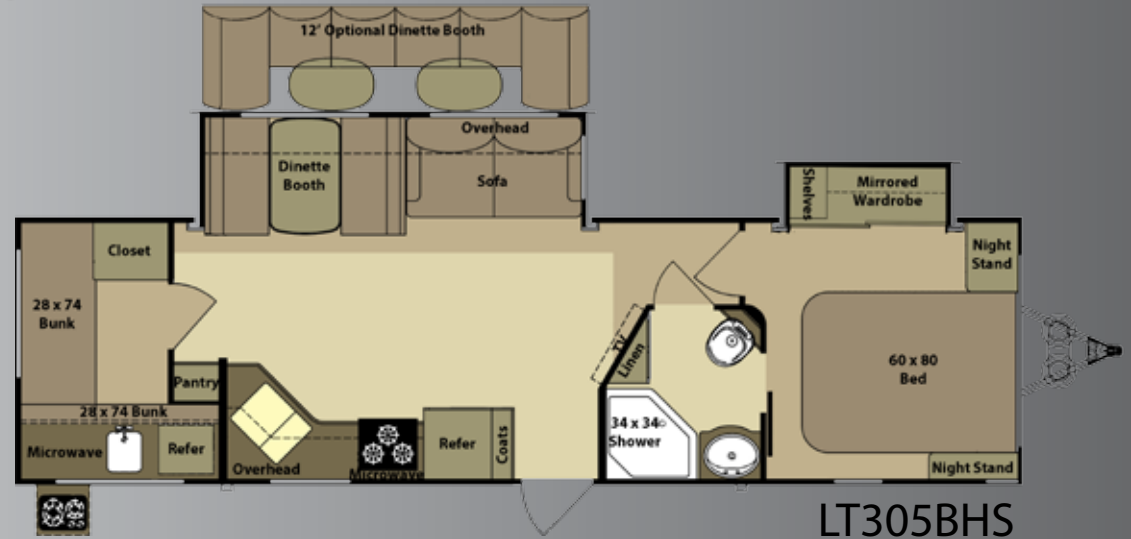

LT305BHS

	GVWR	UVW	Hitch Wt.	Axle Wt.	Gross NCC	Ext. Length	Ext. Height	Ext. Width	Water Heater Gas/Elec	Fresh Water	Gray Water	Waste	LP Gas (Lbs)	Furnace (BTU's)	Tire Size	Awning Size
LT252FLR	7825	5535	825	4710	2290	29'6"	125"	100"	6 Gal	50	62	31	40	30,000	15"	19'
LT305BHS	9595	6805	795	6010	2790	34'4"	125"	100"	6 Gal	50	62	31	40	30,000	15"	16'
LF289RES	9995	7885	1320	6565	2110	31'3"	149"	100"	6 Gal	50	62	31	60	34,000	15"	14'
LF297RLS	9995	7465	1265	6470	2530	31'3"	149"	100"	6 Gal	50	62	31	60	34,000	15"	14'
LF305BHS	9995	7940	1400	6540	2055	34'8"	149"	100"	6 Gal	50	62	31	60	34,000	15"	16'

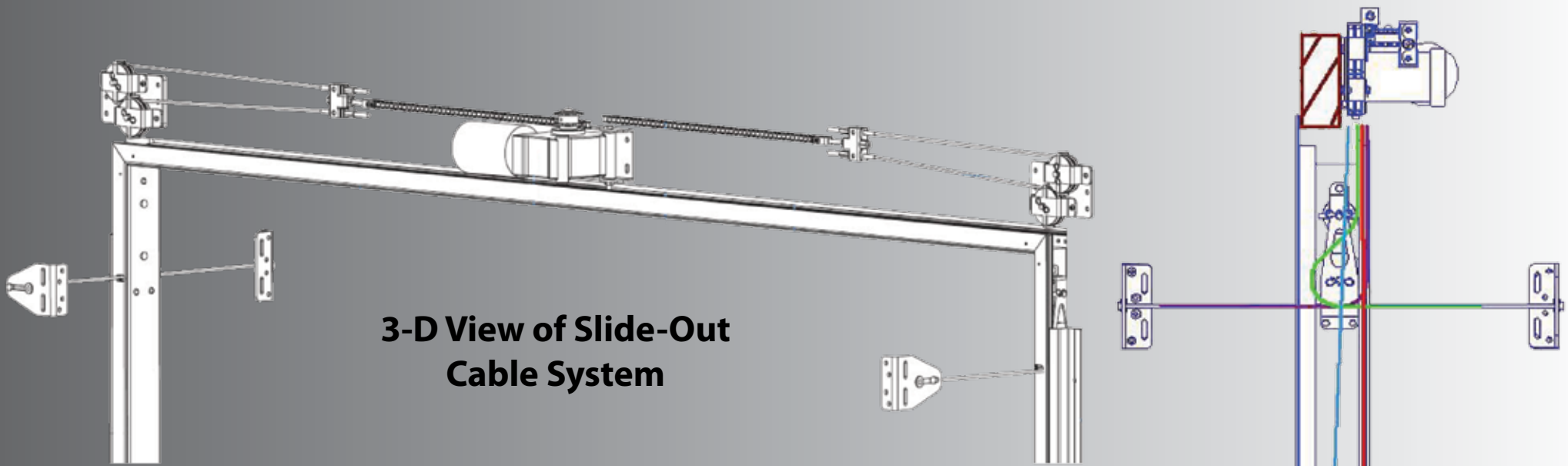

**3-D View of Slide-Out Cable System**

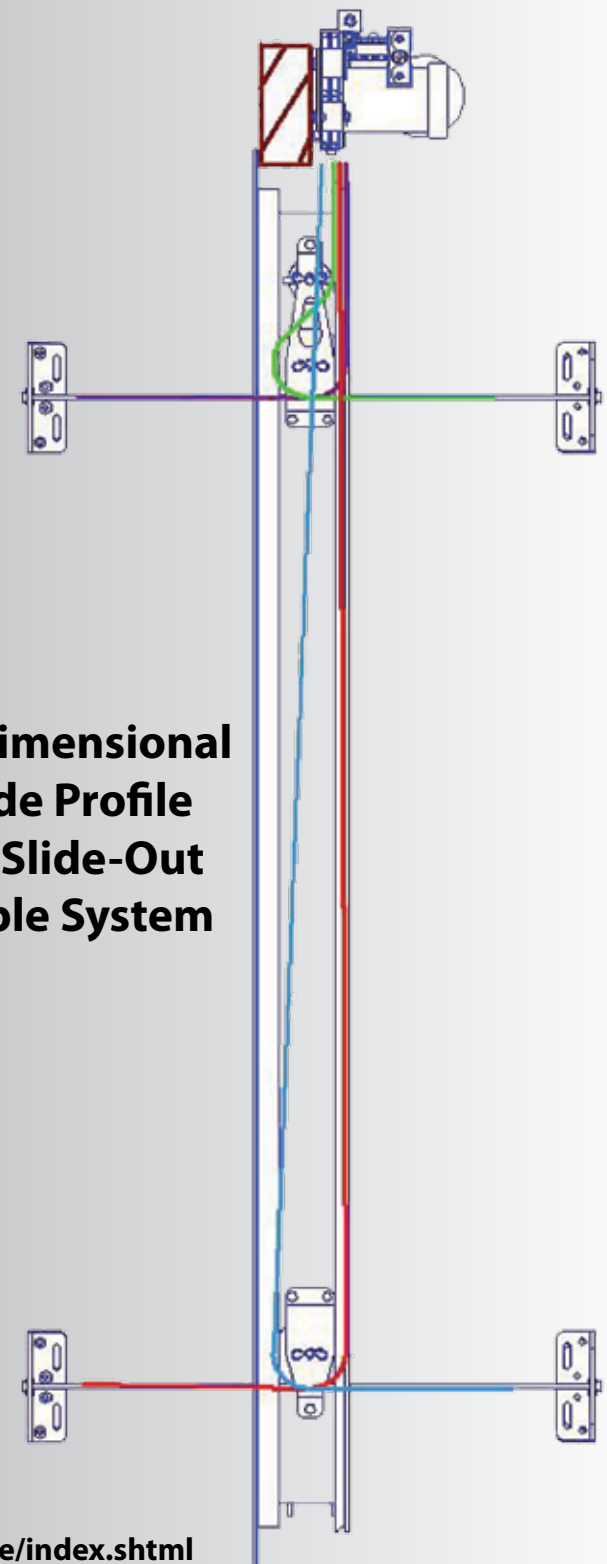

**1- Dimensional Side Profile Of Slide-Out Cable System**

### **10 Reasons Why... Accu-Slide**

- 1. Above floor design means more storage area for your RV**
- 2. Lightweight design promotes fuel savings**
- 3. High strength stainless steel aircraft cable is used for control**
- 4. Cable control at all 4 room corners helps stop leaks**
- 5. Working components are in your RV, safe from the elements**
- 6. Locking motor secures room in or out to help stop leaks**
- 7. Above floor design minimizes maintenance requirements**
- 8. A clean system - no leaky hydraulic lines or greasy drives**
- 9. Smooth, quiet room movement - no jumping or jerking**
- 10. It's built in the U.S.A. and backed by BAL since 1972**



# Interior Construction

**100lb. FULL EXTENSION  
DRAWER GUIDES**



**CABINET CONSTRUCTION**



- Face Frames are Tube Drilled and Screwed for Maximum Strength

**HARDWOOD CABINET CONSTRUCTION**



- Hardwood Cabinet Door Frames & Drawer Faces
- Lumber Core Stiles
- Mortis & Tenon Joints
- Residential Style Hidden Hinges

**7-LAYER BEAUFLOR VINYL FLOORING**

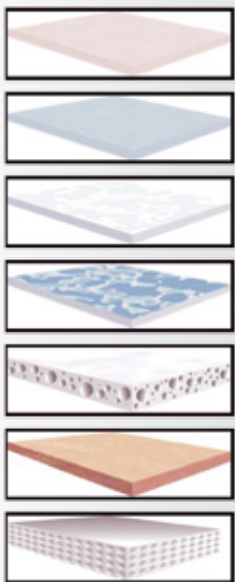

**MORTIS & TENON CABINET  
CONSTRUCTION**

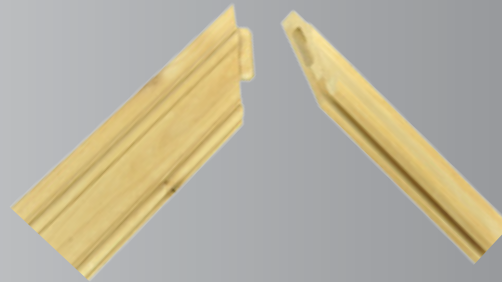

**HIDDEN HINGES**



- Elegant Euro-Style Spring Loaded Hardware
- Keeps Doors Closed Tightly
- Fully Adjustable to Customize Fit

# Exterior Construction

## *1/2" PLYWOOD ROOF DECKING*

- 1/2" Thick Plywood
- 350 lb. Rating
- Constructed with Real Plywood
- More Durable
- Better Quality



## *PVC RUBBER ROOF MATERIAL*

- Ultra Violet Resistant
- No Streaking or Chalking
- No Reconditioning Needed
- 30% Lighter Weight than EPDM Rubber Roof
- Self Extinguishing
- Can be Recycled



## *AUTOMOTIVE STYLE WINDOW SEAL*



## *SYMALITE 1200 SIDEWALL SUBSTRATE*

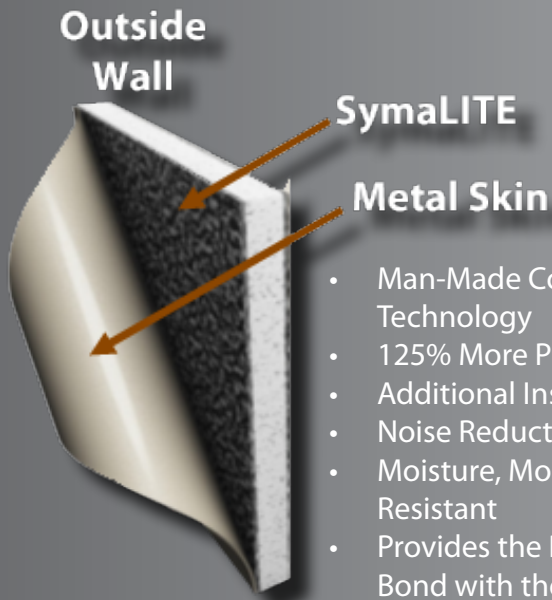

- Man-Made Composite Technology
- 125% More Puncture Proof
- Additional Insulator
- Noise Reduction
- Moisture, Mold, & Swell Resistant
- Provides the Best Possible Bond with the Metal Skin

- At 30% Compression the PVC Foam Seal is 100% Waterproof
- Permanent Seal that Won't Deteriorate
- Provides a Complete and Consistent Seal Throughout

## *PVC FOAM SEALS*



# Fifth Wheel Exterior Features

"Half Ton Series"

4" Extended Drip Spouts



13,500 BTU Ducted A/C



Automotive Style Window Seal

Digital TV Antenna

Carefree  
Power Awning

Fantastic Fan



Optional Gooseneck Adaptor

Baked On Enamel Metallic Paint

Full View Vented Entrance Door



90° Turn Radius Front Cap

King Combo Kingpin  
(Optional Gooseneck Adaptor)

Equa-Flex Suspension



LP Quick Connect



Power Stabilizer Jacks

LP Storage Area

Large Front Storage Area  
(Generator Prep Capable)

90° Turn Radius Front Cap  
even in 5.5' Truck Bed

**Nitro-Fill™**  
Nitrogen  
15" Aluminum Wheels



# Travel Trailer Exterior Features

"Half Ton Series"



Baked On Enamel Metallic Paint

4" Extended Drip Spouts



13,500 BTU Ducted A/C

Digital TV Antenna

MAXAIR VENT COMP

Carefree Power Awning

Full View Vented Entrance Door



Wide Stance Axles

LP Quick Connect



Stabilizer Jacks

Automotive Style Window Seals



Equa Flex Suspension

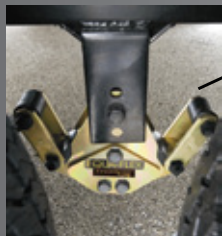

Nitro-Fill Nitrogen 15" Aluminum Wheels

# FOUR SEASONS PROTECTION PACKAGE



- Atwood High Performance Furnace
- Heated Storage Area
- Insulated Slide Floors
- Vented Attic
- Double Insulated Baggage Doors
- Digital Thermostat
- Heated Underbelly
- Heated and Enclosed Dump Valves
- R-38 Roof Insulation\*
- R-38 Floor Insulation\*
- R-9 Sidewalls

**LIGHT HEATING DIAGRAM**

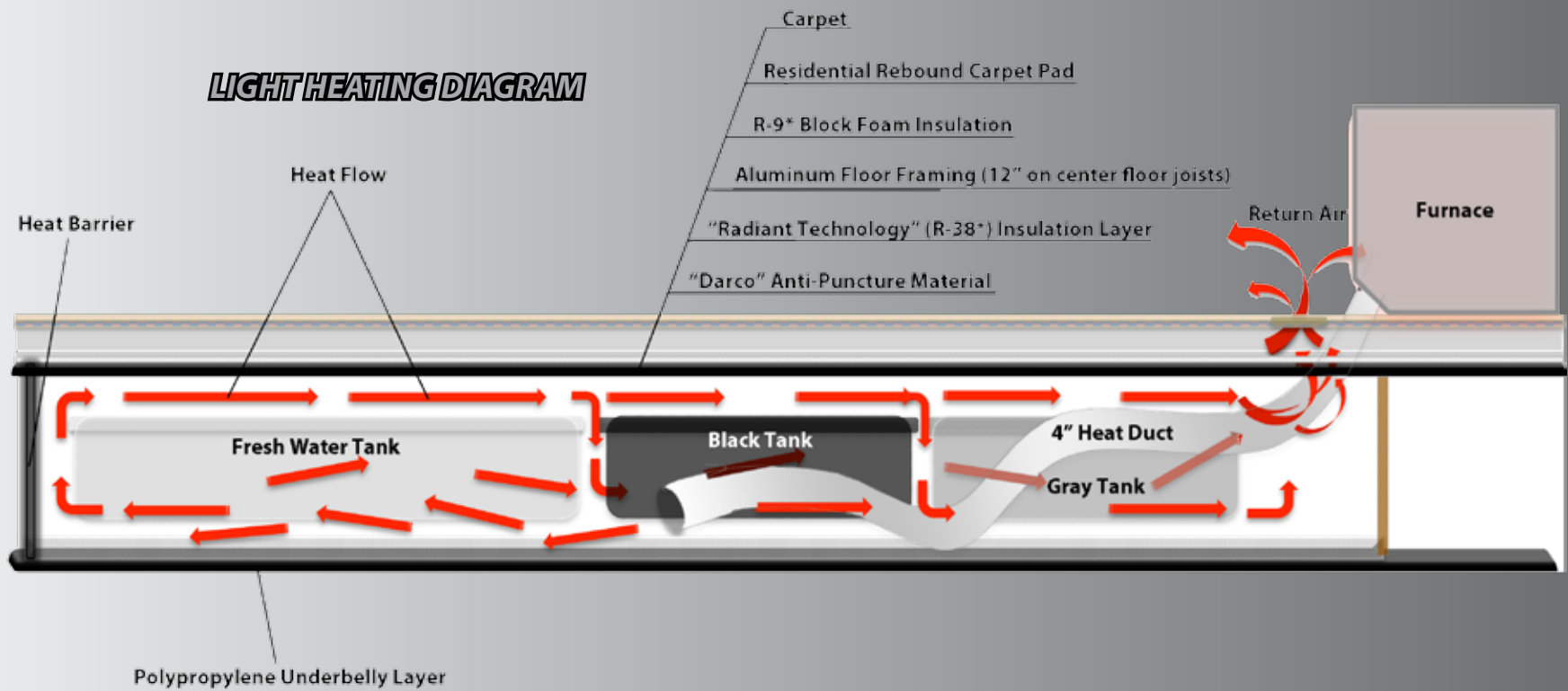

\*=Calculated

# Executive Living Package

## Interior:

- Sofa Bed w/Air Mattress
- Large 6 cu ft Refrigerator
- 6 Gal Gas/Electric Quick Recovery Water Heater
- "Fantastic Fan" (FW Only)
- 13,500 BTU Ducted A/C
- Power Vent
- 80" Residential Size Mattress

## Exterior:

- Power Awning
- 15" Aluminum Wheels
- Assist Grab Handle

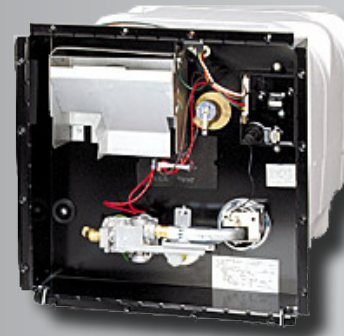

# Entertainment Package

- 32" LCD TV
- 12v CD/DVD/MP3/AM/FM/iPod/USB Stereo
- Cable Hook-Up
- Satellite Hook-Up
- Digital TV Antenna and Booster



Equipped with  
**JACK® DIGITAL  
HDTV ANTENNA**

with Integrated SureLock  
TV Signal Meter!

- No need to crank up or down and is always ready for travel
- Built-in signal meter for fast and accurate antenna pointing
- Full 360° rotation allows for precise antenna pointing with no "dead spot"

A PRODUCT OF  
**KING  
CONTROLS**

# Decors

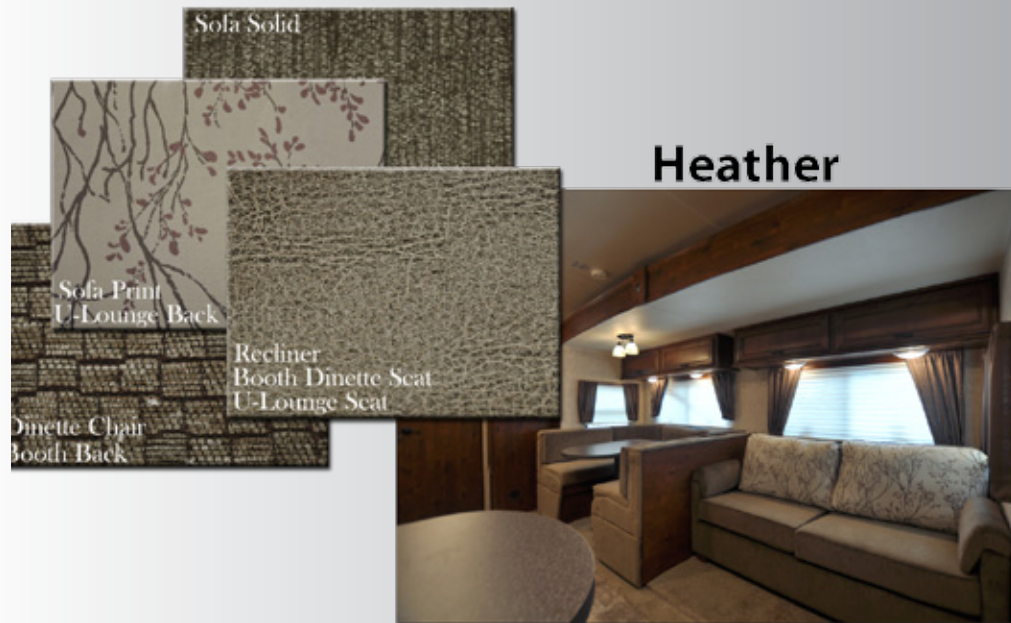

## Interior Standards

- High Output Range w/Igniter and 17" Oven
- Full Extension Drawer Guides
- Shower & Surround
- 50 Amp Service (FW)
- Hardwood Glazed Cabinet Doors
- Waste Basket
- Skylight Above Shower
- Power Vent in Kitchen
- Washer/Dryer Prep (FW)

**TWO-YEAR LIMITED  
TRANSFERABLE WARRANTY**

## Exterior Standards

- Contoured Front Cap for Superior Turning Radius (FW)
- Lippert Wide Stance Axles
- Equa Flex Suspension
- Large Triple 9" Entry Steps (FW)
- Dual Outdoor Security Lights
- Rear Stabilizer Jacks
- Front Power Jacks (FW)
- LP Quick Connect
- Exterior Convenience Center
- Wired and Framed for 2nd A/C (FW)
- Radial Tires
- Large Double 7" Entry Steps (TT)
- Extended Spouts
- Front Stabilizer Jacks (TT)
- Full View Vented Entrance Door

## **PURCHASE LOCALLY**

Open Range RV strongly encourages our retail customers to purchase from their local dealership whenever possible due to the following reasons:

1) Our Dealers are, as a rule, independently owned and operated businesses. Outside of those customers they personally sold products to, they are not obligated to perform warranty service on Open Range RV products that were purchased elsewhere. There may be an occasion that the customer will be required to return to the point of purchase to satisfy warranty requirements.

2) Although many dealerships will eventually service products not purchased at their dealership, they will usually take care of their customers and other Open Range RV customers who are traveling away from their local dealer as a priority.

3) Local purchases allow a customer to establish a relationship with a dealer close to home. This relationship provides the customer with a convenient location for service and support from a "local" professional.

4) The opportunity for a thorough PDI (Pre Delivery Inspection) and product orientation is an additional benefit of buying from a local dealer. The opportunity for refresher courses or the ability to get questions answered more promptly is another additional benefit of buying from a local dealer.

5) For our Canadian customers, there are also requirements which must be met to bring an RV purchased out of the country to their home. Although not impossible, these requirements may involve such things as additional inspections, certifications, taxes and fees. The local Canadian Dealer is a professional at meeting these requirements.

6) Open Range's goal is for all RV Owners to fully enjoy their RV experience. In light of this goal, and considering the advantages of buying locally, we encourage you to be thorough when determining what product to purchase and which dealer to purchase it from as both are key to your ultimate satisfaction.

**Your Open Range Dealer:**



Open Range RV Company 3195 N. St. Rd. 5 Shipshewana, IN 46565

Phone: (260) 768-7771 - [www.OpenRangeRV.com](http://www.OpenRangeRV.com)

Due to continual research and advances, manufacturer reserves the right to change specifications, design, price, and equipment without notice, and assumes no responsibility for any error in the literature. Some items shown are not included as standard or optional equipment

©2011 Open Range RV Company, Shipshewana, Indiana