

2012 ALLEGRO RED



TIFFIN MOTORHOMES



TIFFIN MOTORHOMES

WHEREVER YOU GO, WE GO.



2012 ALLEGRO RED

EXTRA POWER. EXTRA VALUE. EXTRA FUN. Family vacations will never be the same for proud owners of the 2012 Allegro RED from Tiffin Motorhomes. Say goodbye to flight schedules, hotel reservations, and sitting on the suitcase to get it closed. Now, you're free to travel as you please, whenever and wherever. Like the Allegro, the RED is affordable, practical, and value-packed. Floor plan options extend up to 38 feet and are outfitted with four slides to comfortably accommodate everyone and everything. Maximum use of space is a Tiffin trademark, as is our quality workmanship. The RED features the industry's most high-tech exterior paint application, available in five contemporary color schemes with front cap protective film. You'll appreciate the interior craftsmanship too, especially on the kid-friendly bunk beds option. With an optional surround sound system and DVD player, you're well equipped to create a movie theater experience on family night. Don't forget the popcorn.

The fun starts here.

The comforts of home are well addressed in the Allegro RED, making life on the go fun for the whole family. Naturally, the décor has to be just right, and with a choice of three interior color palettes and three cabinet options, there's sure to be a combination that suits your taste. Cozy sofas in the living area invite family and friends to kick back, relax, and enjoy time together. At bedtime, the sofas pull out for extra sleeping space to accommodate guests or stowaways. Up to three TVs will keep everyone happily entertained, with TVs in the living room, bedroom, and the option in the cockpit. Drive by the drive-thru restaurants. You'll be dining on home cooking prepared in the RED's sleek and efficient kitchen, redesigned this year with a new backsplash, residential refrigerator option, and a modern recessed cooktop.



38 QRA Floor Plan/French Roast Interior with English Chestnut Cabinets



U-SHAPED BOOTH DINETTE

Sure to become one of the favorite spots in the coach, the U-shaped dinette available on some floor plans, serves up a cozy place for meals, board games, and conversation.



KITCHEN

Redesigned for 2012, the cooking area is more functional than ever, with a recessed cooktop, neutral tone backsplash, and optional residential fridge.





38 QRA Floor Plan/French Roast Interior with English Chestnut Cabinets



WASHER/DRYER

Available as an optional stacked or combo washer/dryer, nothing can beat the convenience of your on-the-go laundry area.



BEDROOM STORAGE

A place for everything and everything in its place. Deep drawers and roomy cabinets keep personal belongings tucked away.



FULL BATH

The spacious shower stall with skylight is always a customer favorite. But there's also a tub option for those who prefer a relaxing soak.





Cockpit with Color Back-up Monitor and Tilt Steering Wheel

All systems go.

Engineered for maximum comfort and safety, the cockpit of the Allegro RED awaits your command. Controls are exactly as every driver wants them — smartly situated and readily accessible, keeping attention focused on the road. Side-view cameras and color back-up monitor ensure you never lose sight of where you are. The rear engine design delivers many benefits, from increasing legroom for a more spacious cab to decreasing engine noise for a quieter ride. You'll appreciate the diesel engine's increased torque and horsepower too, which can tow up to 5,000 pounds. Hook up the boat and enjoy a shady lakeside retreat under the power patio awning with aluminum weather shield. With up to 160 cubic feet of basement storage, there's room for everything you need, from fishing gear to a BBQ grill.

DASH DETAIL

The cab is the driver's domain, able to provide information on demand so that attention never leaves the road.



SIDE-VIEW CAMERAS

With mirrors, side-view cameras, and a color back-up monitor, the well-equipped dash eases the concerns of driving in busy traffic or tight parking situations.



BASEMENT STORAGE

The pass-thru basement makes access easier than ever, and with up to 160 cubic feet of space, you'll find packing for trips easier, too.



Driven By You

Top performance begins from the road up. Tiffin Motorhomes is proud to offer the Freightliner® Chassis, our standard chassis on the Allegro RED, as our two companies share a deep commitment to excellence and customer service. In our long association, Freightliner has earned a stellar reputation with Tiffin owners by delivering a premium ride, more maneuverability, ongoing owner education, a nationwide service network, and 24/7 factory direct customer support. Their warranty offers the assurance of comprehensive coverage: a transferable, 3-year, 50,000-mile limited warranty with towing and roadside assistance with no deductible. The Allison® transmission is covered with a 5-year unlimited mileage warranty and the Cummins® engine provides a 5-year, 100,000-mile warranty. For more information about the XC-R motor home chassis, visit freightlinerchassis.com



Freightliner® Custom Chassis

- 1 Tilt-and-telescoping steering column adjusts for driver comfort
- 2 55° wheel cut for greater maneuverability
- 3 18" VIP Steering Wheel
- 4 Large air springs with ping tanks for a superior ride
- 5 Large volumetric air springs and transverse beam provides superior ride and roll stability
- 6 Custom-tuned Sachs shock absorbers
- 7 9" high steel frame rails with cross-members for solid foundation
- 8 Cummins ISB Engine 340 HP/660 Ft.-Lbs. Torque
- 9 Engine position provides better ride and smoother handling
- 10 Electronically controlled viscous on/off fan clutch provides improved fuel economy and performance

Interior Décor

As attractive as Tiffin coaches are on the outside, the interior is where we excel. After all, this is the place you call home. Our interior designers have put together a selection of neutral color schemes to suit many decorating styles. Last year's popular Marble option is available, along with two new interior schemes, French Roast and Raven. Each option beautifully complements the tones found in the decorative accents and hardwood cabinetry handcrafted in our Red Bay mill shop.

Cabinets



Medium Alderwood



English Chestnut



Cherry Bark

Flooring & Countertops



Carpet



Tile



Countertop

French Roast Fabric Suite

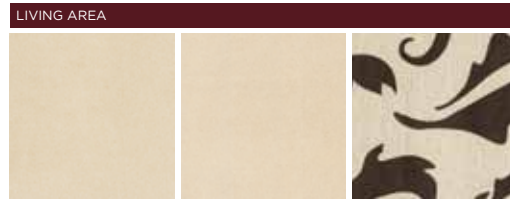

Sofa

Accent

Dinette

Marble Fabric Suite

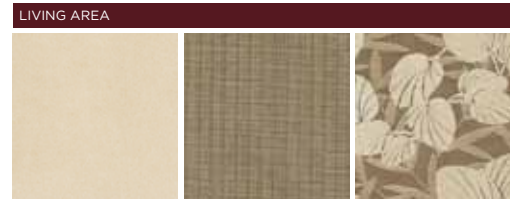

Sofa

Accent

Dinette

Raven Fabric Suite

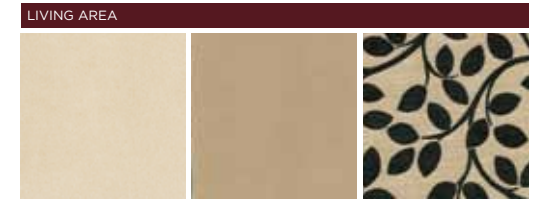

Sofa

Accent

Dinette



Main

Accent



Main

Accent



Main

Accent

Allegro RED cabinet doors are made of solid wood, and all cabinet finishes are available in combination with any fabric suite. All options may not be available in every model. Because of progressive improvements, specifications, standard & optional equipment are subject to change without notice or obligation. For a complete and up-to-date list of available options and specifications, visit tiffinmotorhomes.com

Full-body Paint Schemes

Full-body paint is standard on the 2012 Allegro RED, as is the protective film that seals in the paint to help retain the fresh-painted shine. Tiffin's paint facility is one of the largest in the country and features a state-of-the-art air filtration system that ensures an impeccable finish. Quality control checks are integrated into the painting process. Meticulous attention is given to every single inch of the Allegro RED to produce the most precise application.



Gold Coral



Maroon Coral



Silver Sand



Sunlit Sand



Rocky Mountain Brown

Structural/Construction

STANDARD ON ALL MODELS:

- Laminated Floor, Sidewall & Roof
- Steel/Aluminum Reinforced Structure
- One-piece Molded Fiberglass Roof Cap

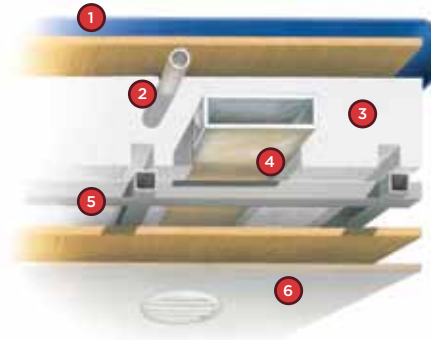

Roof

- 1 One-piece, moisture resistant molded fiberglass roof cap provides insulation and strength and prevents water intrusion
- 2 A/C Condensation Drainage System that runs internally through the roof insulation and down the sidewalls, redirecting water underneath the motor home
- 3 5 1/2" formed insulation
- 4 Quiet Air Cooling System with return air and foil-wrapped cooling exhaust ducts
- 5 Durable, tubular aluminum roof skeleton
- 6 Easy-to-clean soft touch vinyl ceiling panel

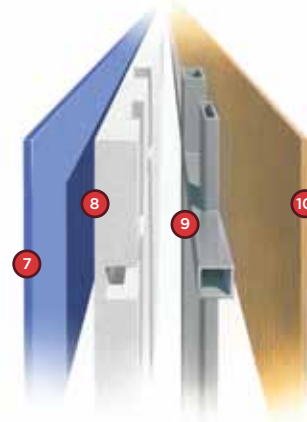

Sidewall*

- 7 Gel-coat fiberglass outside wall panel
- 8 High-performance thermal insulation
- 9 Durable, yet lightweight, tubular aluminum wall skeleton
- 10 Decorative inside wall panel

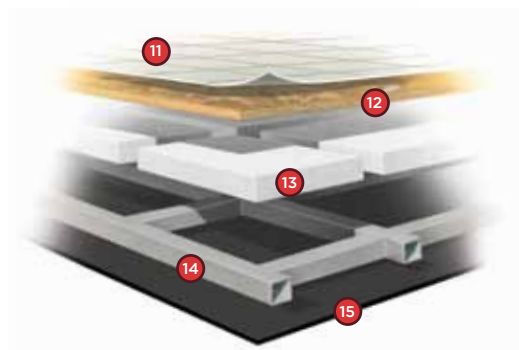

Floor

- 11 Vinyl tile floor bonded to high-impact oriented strand board
- 12 High-level engineered oriented strand board
- 13 High-performance thermal insulation
- 14 Durable, tubular floor skeleton
- 15 Woven moisture barrier material

*All sidewalls are approximately 2" thick.

Specifications

Automotive

STANDARD ON ALL MODELS:

- Raised Rail Chassis Frame
- Air Ride Suspension
- Full Air Brakes
- Exhaust Brake

Chassis

FREIGHTLINER® REAR ENGINE DIESEL CHASSIS:

Engine	Cummins ISB 6.7-liter Electronic Diesel, Turbocharged, Aftercooled			
Peak HP	340 HP @ 2,600 RPM			
Peak Torque (Lb.- Ft. Max Net)	660 @ 1,600			
Transmission	Allison 2500 MH 6-speed Automatic with Lock-up			
GAWR—Front	12,000 Lb.			
GAWR—Rear	17,500 Lb.			
GVWR	29,500 Lb.			
GCWR	33,000 Lb.			
Wheel Base	208" (34 QFA)	228" (36 QSA)	252" (38 QBA)	252" (38 QRA)
Tire Size	275/80R22.5			
Fuel Tank (Gallons)—Dual Fuel Fill	100			
Alternator Amps	160			
Trailer Hitch Capacity	5,000 Lb.			

Weights & Measures

OVERALL:	34 QFA	36 QSA	38 QBA	38 QRA
Overall Length (Approximate)	34' 10"	36' 9"	38' 9"	38' 9"
Overall Height with Roof Air (Maximum)	12' 10"	12' 10"	12' 10"	12' 10"
Interior Height	84"	84"	84"	84"
Overall Width	101"	101"	101"	101"
Interior Width	96"	96"	96"	96"
Fresh Water (Gallons)	90	90	90	90
Black Water (Gallons)	50	50	50	50
Grey Water (Gallons)	70	70	70	70
LPG Tank (Gallons; can only be filled to 80% capacity)	24	24	24	24
Basement Storage (Cubic Feet - Approximate)	87	150	160	160
Minimum Garage Height	13'	13'	13'	13'
DEF Tank* (Gallons)	13	13	13	13

*Diesel Exhaust Fluid (DEF) is the active component used in Selective Catalytic Reduction (SCR) engines to reduce nitrogen oxide emissions by 90% to meet EPA standards.

All options may not be available in every model. Because of progressive improvements, specifications, standard & optional equipment are subject to change without notice or obligation. For a complete and up-to-date list of available options and specifications, visit tiffinmotorhomes.com

Exterior

STANDARD ON ALL MODELS:

- Fiberglass Front & Rear Caps
- Tinted One-piece Windshield
- 6.0 kw Onan® Generator
- Horizontal Mounted Wipers
- Heated Power Mirrors
- Exterior Patio Light
- Power Patio Awning with Aluminum Weather Shield
- Slide-out Awning(s)
- Chrome Wheel Liners
- Quiet A/C Roof-ducted System
- Two 13,500 BTU High Profile Roof Air Conditioners
- Double Electric Step
- 1/4" Thick Single Pane Windows
- Convenient Access Doors with Gas Shocks
- Ridged Long-life Storage Boxes
- Single Handle Lockable Storage Door Latches
- Heated Water & Holding Tank Compartments
- Four 6 V Auxiliary Batteries
- Park Telephone Ready
- Digital TV Antenna
- Cable Ready TV
- 50 Amp Service
- Black Holding Tank Flush System
- Exterior Rinse Hose/Shower
- Gravity Water Fill
- Color Back-up Monitor
- 110 V Exterior Receptacle
- Undercoating
- Roof Ladder
- External Tripod Satellite Hook-up
- Exterior Storage Compartment Lights
- Side-view Cameras Activated by Turn Signals
- BASF Full-body Paint with Protective Film on Front Cap
- Hydraulic Automatic Leveling Jacks

AVAILABLE OPTIONS:	34 QFA	36 QSA	38 QBA	38 QRA
8.0 kw Onan® Generator	O	O	O	O
Automatic Satellite Dish*	O	O	O	O
Automatic Entry Door Awning	O	O	O	O
Hadley Air Horns	O	O	O	O
Two 15,000 BTU High Profile Roof Air Conditioners with Heat Pump (8.0 kw Generator Only)	O	O	O	O
CB Antenna	O	O	O	O

*High-definition programming is not available on a domed satellite antenna unless you subscribe to DISH Network®.

Cockpit

STANDARD ON ALL MODELS:

- Entry Floor Light
- Tilt Steering Wheel
- Dual Dash Fans
- Lighted Instrument Panel
- CD Player & AM/FM Stereo
- 12 V Dash Receptacle
- Power Solar/Privacy Windshield Shades
- Step Switch & 12 V Disconnect Switch
- Non-power Cloth Driver & Passenger Seats
- Manual Driver & Passenger Solar/Privacy Shades
- Fire Extinguisher
- Snack/Beverage Tray
- Adjustable Seatbelt Brackets

AVAILABLE OPTIONS:	34 QFA	36 QSA	38 QBA	38 QRA
Power Cloth Driver & Passenger Seats	O	O	O	O
Power Halo Leather Driver & Passenger Seats	O	O	O	O
Front Overhead TV	O	O	O	O

Living Area/Dinette

STANDARD ON ALL MODELS:

- Booth Dinette with Large Pullout Storage Drawers
- Decorative Wall Hanging

AVAILABLE OPTIONS:	34 QFA	36 QSA	38 QBA	38 QRA
Cloth DE Sofa/Sleeper on Passenger Side	NA	S	S	NA
Halo Leather DE Sofa/Sleeper on Passenger Side	NA	O	O	NA
Cloth Air Coil Hide-A-Bed Sofa/Sleeper on Passenger Side	S	NA	NA	S
Halo Leather Air Coil Hide-A-Bed Sofa/Sleeper on Passenger Side	O	NA	NA	O
Cloth Air Coil Hide-A-Bed Sofa/Sleeper on Driver Side	NA	O	O	NA
Halo Leather Air Coil Hide-A-Bed Sofa/Sleeper on Driver Side	NA	O	O	NA
Cloth DE Sofa/Sleeper on Driver Side	NA	S	S	NA
Halo Leather DE Sofa/Sleeper on Driver Side	NA	O	O	NA
Cloth U-shaped Dinette with Drop Down Table	S	NA	NA	S
Halo Leather U-shaped Dinette with Drop Down Table	O	NA	NA	O
Freestanding Dinette with Built-in Cabinets	NA	O	O	NA
Freestanding Dinette with Computer Workstation	NA	O	O	NA
DVD Player (NA with Surround Sound System)	O	O	O	O
Home Theater Surround Sound System (Includes DVD Player)	O	O	O	O

Kitchen

STANDARD EQUIPMENT ON ALL MODELS:

- Double Bowl Kitchen Sink with Single Lever Bronze Faucet
- Solid Surface Countertops
- Stacked Drawers
- Solid Surface Backsplashes
- 3-burner Recessed Cooktop with Gas Oven
- Microwave with Exterior Venting
- 10 Cubic Foot 2-door Refrigerator

AVAILABLE OPTIONS:	34 QFA	36 QSA	38 QBA	38 QRA
Convection Microwave	O	O	O	O
Cooktop and Convection Microwave (No Gas Oven)	O	O	O	O
Icemaker in 2-door Refrigerator	O	O	O	O
4-door Gas/Electric Refrigerator with Icemaker	O	O	O	O
Solid Wood Refrigerator Panels	O	O	O	O
Residential Refrigerator with 4 Total House Batteries	O	O	NA	O

Bath

STANDARD EQUIPMENT ON ALL MODELS:

- Medicine Cabinet
- Skylight in Shower
- Bronze Vanity Faucet
- Molded Fiberglass One-piece Shower
- Solid Surface Vanity Top
- Fantastic® Fan

AVAILABLE OPTIONS:	34 QFA	36 QSA	38 QBA	38 QRA
Tub (in Place of Shower)	O	NA	O	O

Bedroom

STANDARD EQUIPMENT ON ALL MODELS:

- Wardrobe with Automatic Light
- Bed Comforter with Throw Pillows
- TV
- Tile Flooring
- Inner Spring Queen Mattress (60" x 80")
- Solar/Privacy RollEase® Shades

AVAILABLE OPTIONS:	34 QFA	36 QSA	38 QBA	38 QRA
Bunk Beds (30" x 72") with Bunk Ladder/Convertible Wardrobe	NA	NA	S	NA
DVD Monitors in Bunk Beds	NA	NA	O	NA
King Bed (72" x 80")	O	NA	NA	O

Interior

STANDARD EQUIPMENT ON ALL MODELS:

- Raised Panel Hardwood Cabinet Doors
- Soft Touch Vinyl Ceiling
- Solid Wood Cabinet Faces
- LED Bulbs in Ceiling Lights Only
- Midsection TV in Entertainment Center
- Wall-to-wall Vinyl Tile Flooring Throughout Coach
- Ball Bearing Drawer Slides
- Scotchgard® Treated Fabrics
- Solar/Privacy RollEase® Shades
- Power Roof Vents
- Tank Level Monitor System
- Smoke Detector
- 10-gallon DSI Gas/Electric Water Heater
- Folding Step Well Cover
- Carbon Monoxide Detector
- LPG Leak Detector

AVAILABLE OPTIONS:	34 QFA	36 QSA	38 QBA	38 QRA
2000 Watt Inverter (Must Select with Residential Refrigerator)	O	O	O	O
Central Vacuum Cleaner	O	O	O	O
Combo Washer/Dryer	O	O	O	O
Stacked Washer/Dryer	O	O	O	O
Cherry Bark Solid Cabinet Doors & Drawer Fronts	O	O	O	O
English Chestnut Solid Cabinet Doors & Drawer Fronts	O	O	O	O
Medium Alderwood Solid Cabinet Doors & Drawer Fronts	O	O	O	O

Floor Plans* & Options

There's an Allegro RED floor plan perfect for how you live. That's because all Tiffin floor plans are based on ideas and recommendations from customers like you, folks who share your lifestyle needs. We actively survey owners for their suggestions on modifications that can help improve the flow and functionality of our layouts. Our engineers utilize every single inch of each plan, giving you room to roam on the inside while you roam on the outside.

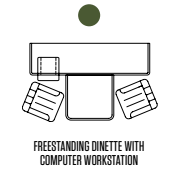
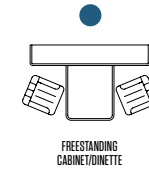
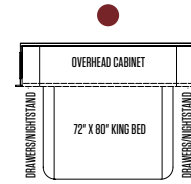

34 QFA

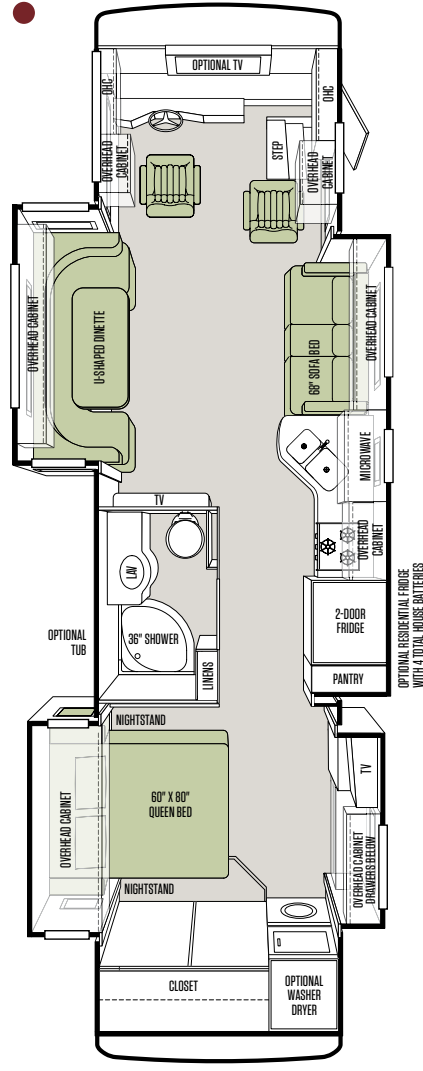

36 QSA

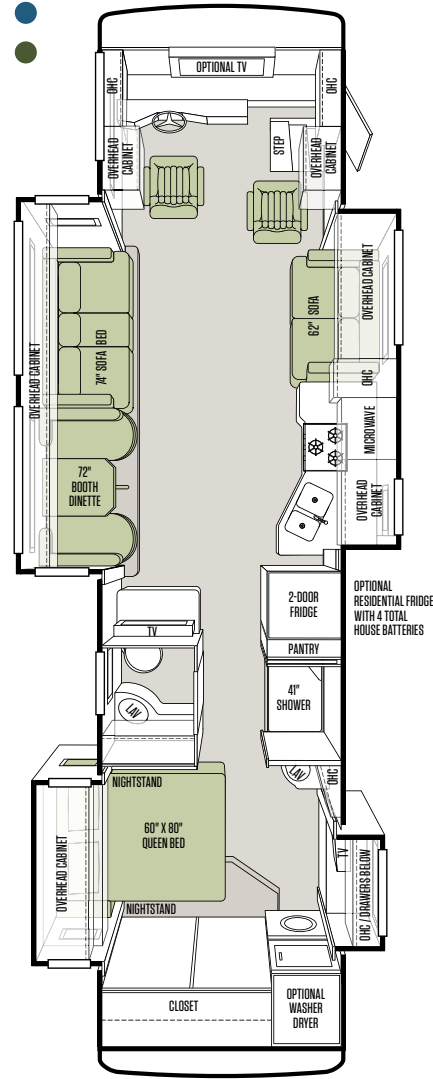

38 QBA

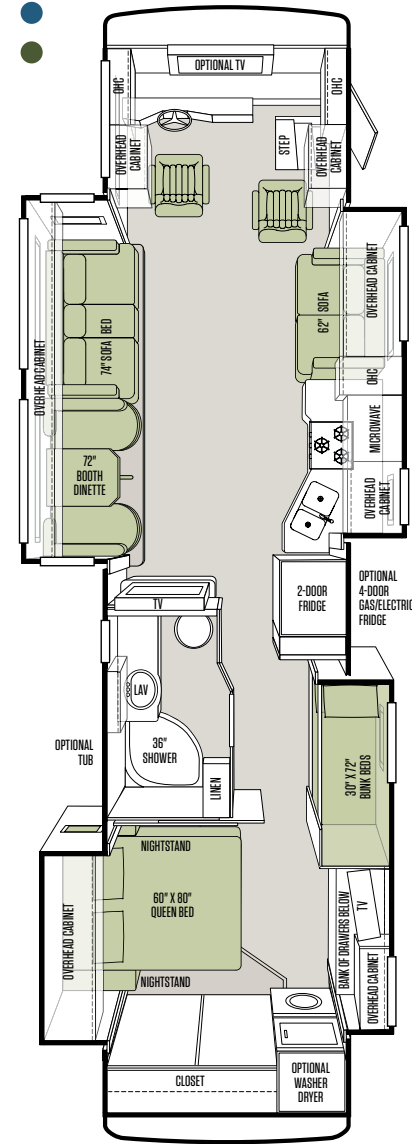

38 QRA

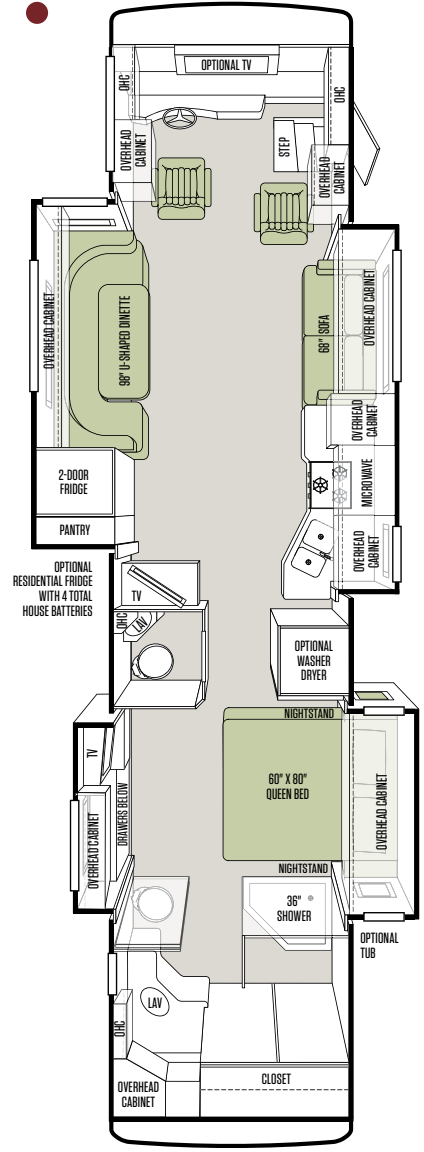

*Additional floor plans may be added throughout the model year. For a complete and current list of available floor plans and options, visit us online at tiffinmotorhomes.com

ALLEGRO RED

Why buy a Tiffin Motorhome?

Every company under the sun talks about quality. For some, that's all it is—talk. Unlike our competitors, Tiffin Motorhomes produces many of our own parts. Not only does this give us complete control over quality, it enables us to later provide replacement parts for older models. That means, on a Tiffin coach, Tiffin craftsmen also manufactured the windows, moldings, fiberglass, textiles, finishes, millwork, custom cabinetry, and, on some models, the chassis. Building the best motor homes in the industry is our goal, and keeping a close eye on quality is always one way you can count on us to deliver.

10-YEAR LIMITED FRAME WARRANTY

We warranty the frame of the walls, floors, and roof for 10 years.

5-YEAR LIMITED SIDEWALL BOND WARRANTY

We warranty the sidewall against delamination between the outside fiberglass and the inner frame for 5 years.

tiffinmotorhomes.com

Visit us on the web for more information on the 2012 Allegro RED and all of our 2012 Tiffin Motorhomes, as well as the latest product and specification updates. Plus, watch videos and see other exclusive web content.

FOR PARTS & SERVICE CALL 256/356.0261

YOUR LOCAL TIFFIN DEALER:

TIFFIN MOTORHOMES



This year, Tiffin Motorhomes proudly celebrates our 40th year of building the finest motor homes on the road. What an amazing ride we've had—and are still having. Thanks to everyone who has been a part of our journey, from our dedicated team to our wonderful customers. We sure couldn't have done it without you. Fasten your seatbelts, everybody, and let's get going to make it another 40 years!

Safe travels,

Bob Tiffin

President/Founder



SOME INTERIOR FURNISHINGS NOT INCLUDED. UNLESS WHERE NOTED, ALL CONTENT ©2011 TIFFIN MOTORHOMES, INC. ALLEGRO®, ALLEGRO BREEZE®, ALLEGRO RED®, PHAETON®, ALLEGRO BUS®, ZEPHYR®, ROUGHING IT SMOOTHLY®, OPEN ROAD®, POWERGLIDE®, AND PUSHER® ARE REGISTERED TRADEMARKS OF TIFFIN MOTORHOMES, INC. ALL RIGHTS RESERVED.

105 2ND STREET NW, RED BAY, ALABAMA 35582
CALL 256/356.8661 FAX 256/356.8219

