





Enjoying the Journey.....



SERVICE, PARTS & WARRANTY BUILDING



PLANT TWO



MAIN HEADQUARTERS- PLANT ONE

On a Mission

At Open Range RV, we are on a mission to...

Fulfill the trailer needs of our dealer base and retail customers, and in doing so, exceed their expectations for service, quality and value.

Earn our dealers', retail customers' and employees' long-term loyalty by delivering more than we promise, in a fair and honest business manner.

Motivate our employees to provide exceptional service and quality to our retail customers and dealers.

Compensate our employees fairly and provide opportunity for personal growth within our company.

Although it is our goal to provide a product that exceeds our customer needs and level of quality, we do not strive to be the biggest or the most profitable. In the end, we believe satisfied customers, dealers and employees will bring growth and long term profitability for all.

For almost 30 years, I have had the great fortune to work in the amazing industry of RV manufacturing. This industry runs through my blood and is the passion of my life. This has been a dream come true for me and my family. I would like to thank everyone who believed in us as an RV Manufacturer. At Open Range our motto is ENJOY THE JOURNEY!

It has been an amazing JOURNEY so far! Come join us on this great JOURNEY, we don't want you to miss another moment of it.

Enjoy the Journey!



Randy Graber, President
Open Range RV Company



Model 386FLR Kitchen in Pinto Decor

DUAL LEAF DINETTE TABLE



- Hardwood Table Top with Dual Leaf to Sit up to 6 People!
- Includes Dinette Ladder Chair
- Promotes Family Style Dining for Everyone!



FULL EXTENSION STAINLESS STEEL BALL BEARING DRAWER GUIDES



CORIAN COUNTERTOPS

WITH FLUSH MOUNTED SINK COVERS



- Durable Finish for Years of Use
- Nonporous Surface - Easy to Clean
- Easy Repair if Damaged
- Stainless Steel Sink
- Single Lever Pullout Spray Faucet



PULL OUT TRASH CAN



Model 386FLR Living Room in Pinto Decor



386FLR TV in Up Position

**"COMFORT CLOUD" FIRM
FOAM PILLOW TOP MATTRESS**



***RADIUS BED BASE WITH
TONS OF STORAGE***

- Easy Lift Strut Assist
- Radius Base for Easy "Walk Around"
- Full Depth Base to Fit all Your Items



Open Range Floorplans

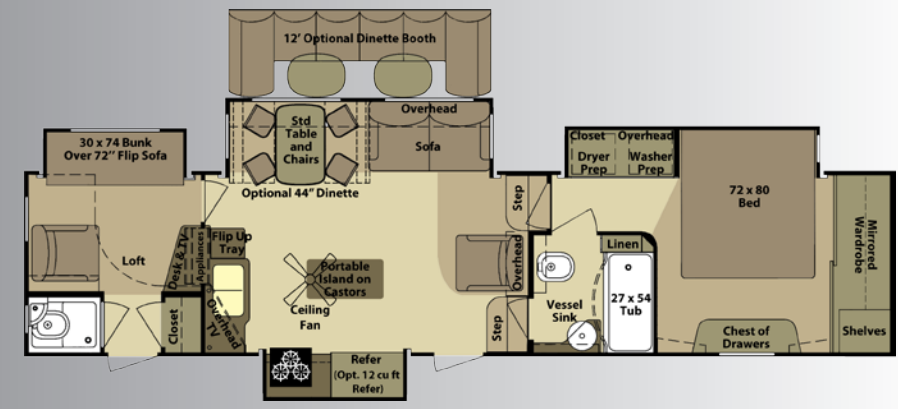
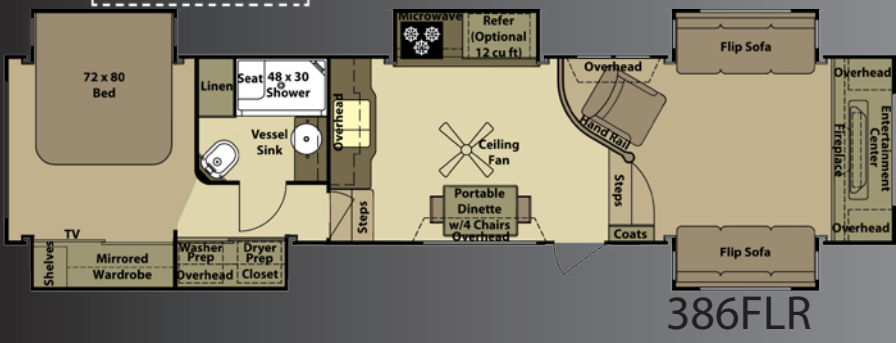
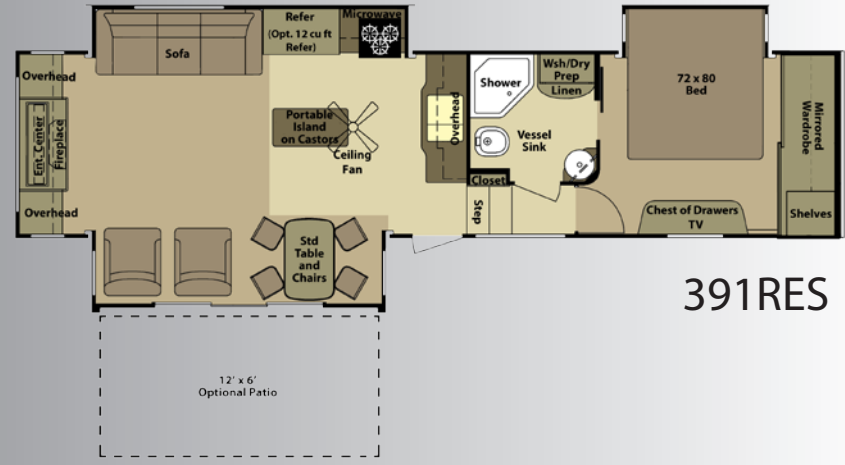

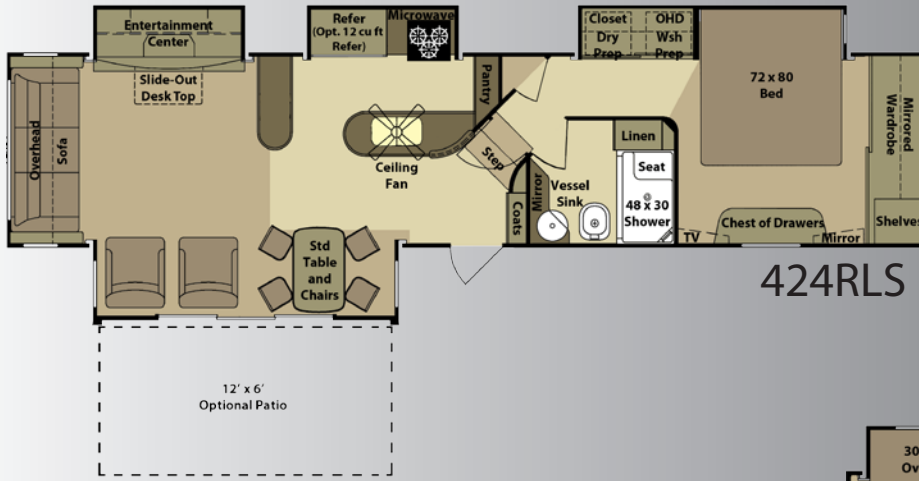

424RLS

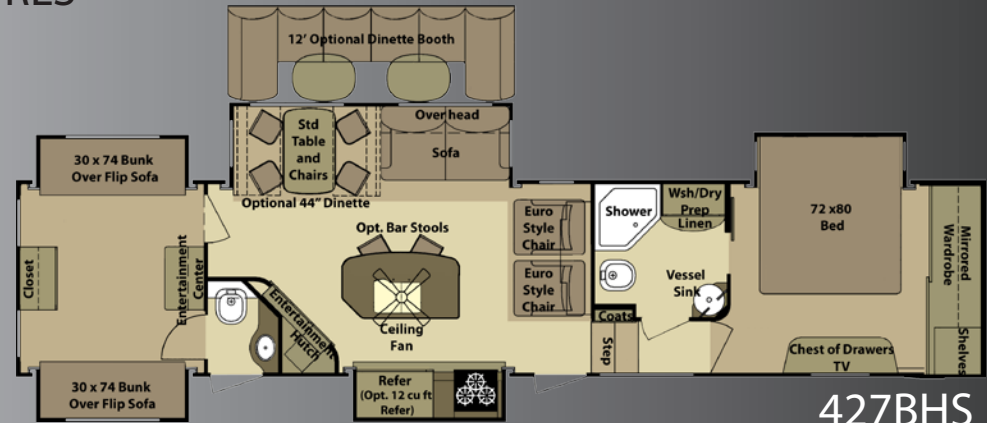

427BHS

	GVWR	UVW	Hitch Wt.	Axle Wt.	Gross NCC	Ext. Length	Ext. Height	Ext. Width	Water Heater Gas/Elec	Fresh Water	Gray Water	Waste	LP Gas (Lbs)	Furnace (BTU's)	Tire Size	Awning Size
345RLS	12560	8960	2160	6800	3600	34'6"	155"	100"	10 Gal	85	57	41	80	35,000	16"	16'
359RKS	14290	10010	2090	7720	4280	35'6"	155"	100"	10 Gal	85	82	41	80	35,000	16"	16'
386FLR	16515	11205	2515	8690	5310	40'	155"	100"	10 Gal	85	57	41	80	40,000	16"	15'
391RES	13920	10380	1920	8460	3540	37'6"	155"	100"	10 Gal	85	57	41	80	40,000	16"	16'
399BHS	13990	10995	1990	9005	2995	38'6"	155"	100"	10 Gal	85	82	82	80	40,000	16"	16'
413RLL	16165	11970	2165	9805	4195	39'9"	155"	100"	10 Gal	85	82	82	80	40,000	16"	19'
424RLS	16280	11695	2280	9415	4585	40'	155"	100"	10 Gal	85	82	41	80	40,000	16"	16'
427BHS	17520	11840	1920	9920	5680	41'9"	155"	100"	10 Gal	85	82	82	80	40,000	16"	16'

Residential



Model R412RSS Kitchen in Sedonna Decor

EXTRA LARGE RESIDENTIAL PANTRY WITH SWINGING SHELVES



SOLID CORE 6-PANEL DOOR TO WASHROOM



- Elegant Knotty Alder Bath & Bedroom Doors
- High End Look & Feel
- Durable Quality
- Easy to Open & Close

SOLID CORE FRENCH DOOR TO BEDROOM



23 CUBIC FOOT REFRIGERATOR

- Frigidaire Residential Style Refrigerator
- Tons of Storage Space!
- Ice Maker and Water Dispenser
- Designated Battery Plumbed to Refrigerator
- Built in 600w Inverter





EXTRA DEEP CHEST OF DRAWERS



- 100 lb. Ball Bearing Drawers Guides
- Full Extension for Easy Access
- Drawer Bottom Support Brace for Quality that Lasts

TRIPLE SLIDING MULLION WARDROBE DOORS



Model R412RSS Bedroom in Sedonna Decor

ONEPIECE FIBERGLASS SHOWER

- No Seams or Cracks
- Easy to Clean
- Elegant Shower Seat
- Spacious Interior
- Thick Base for Maximum Strength



Residential Floorplans

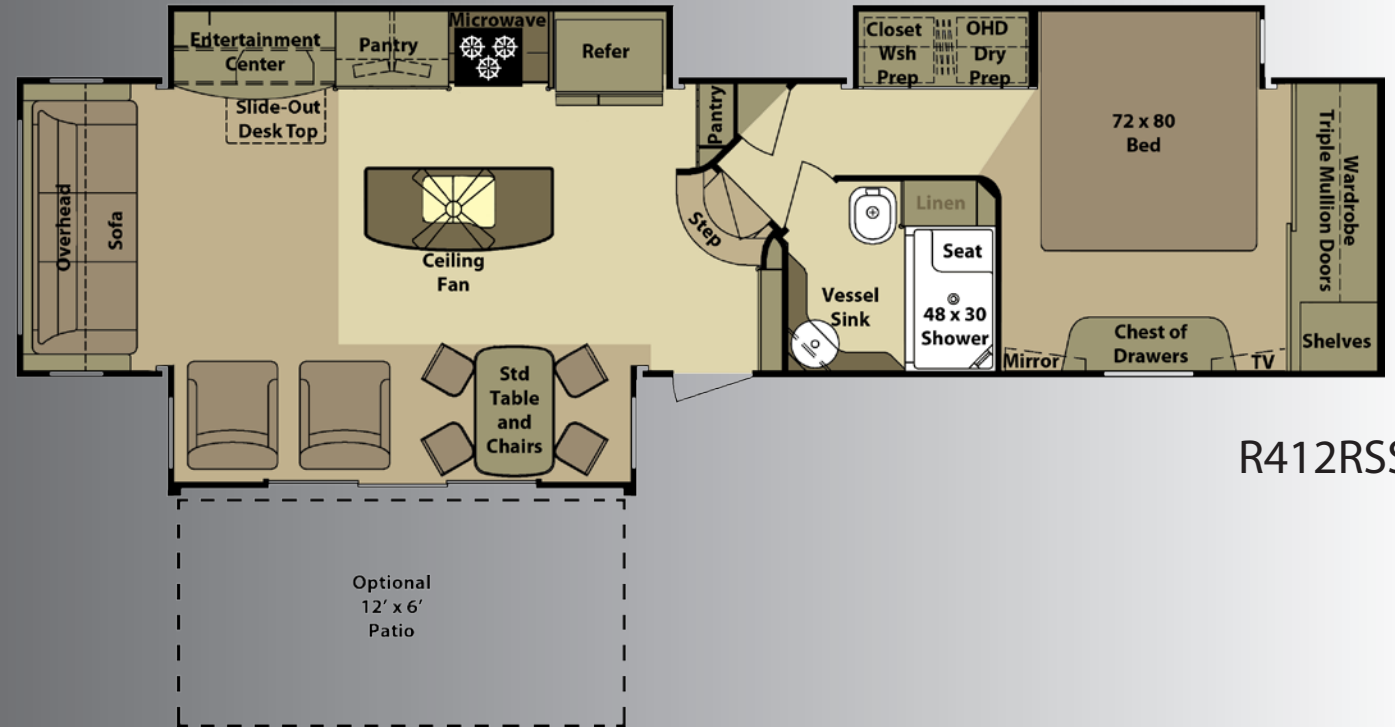
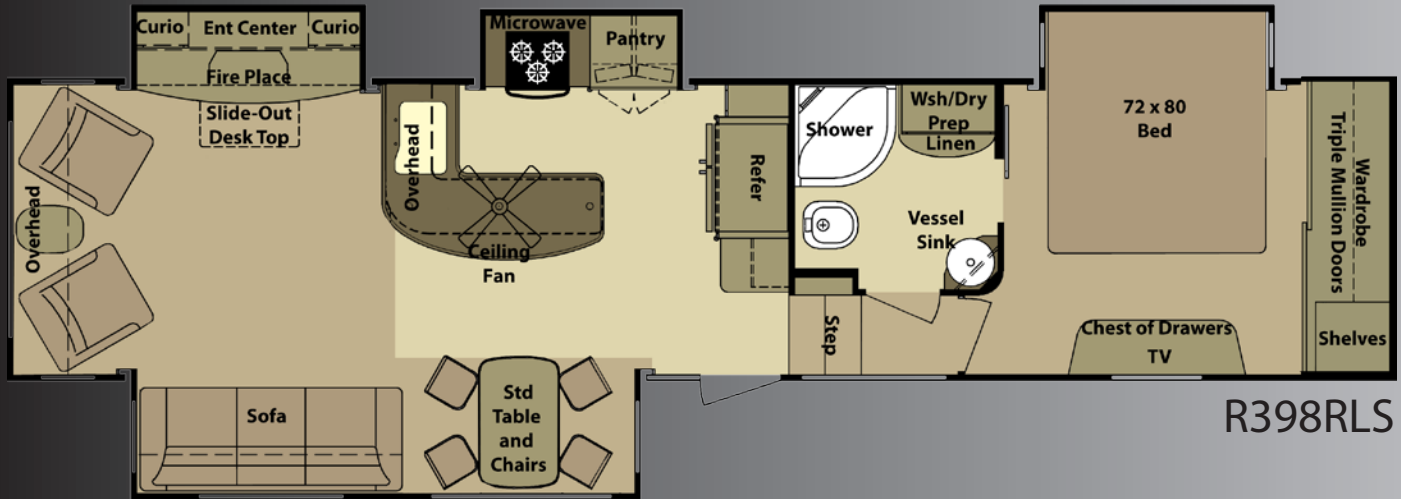

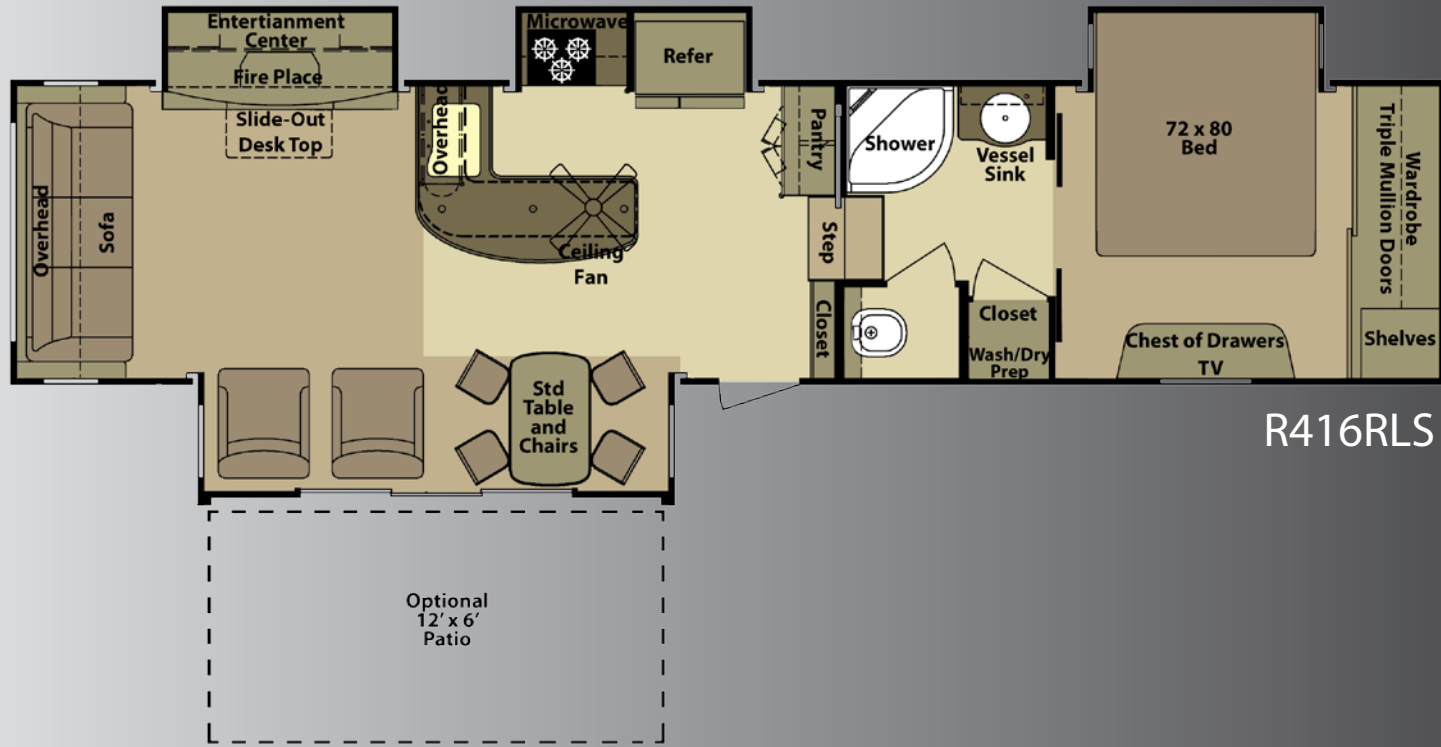

R416RLS

	GVWR	UVW	Hitch Wt.	Axle Wt.	Gross NCC	Ext. Length	Ext. Height	Ext. Width	Water Heater Gas/Elec	Fresh Water	Gray Water	Waste	LP Gas (Lbs)	Furnace (BTU's)	Tire Size	Awning Size
R398RLS	13960	10995	1960	9035	2965	39'	155"	100"	10 Gal	85	82	41	80	40,000	16"	16'
R412RSS	14185	11165	2185	8980	3020	38'9"	155"	100"	10 Gal	85	82	41	80	40,000	16"	16'
R416RLS	15995	11805	2555	9250	4190	40'	155"	100"	10 Gal	85	82	41	80	40,000	16"	16'

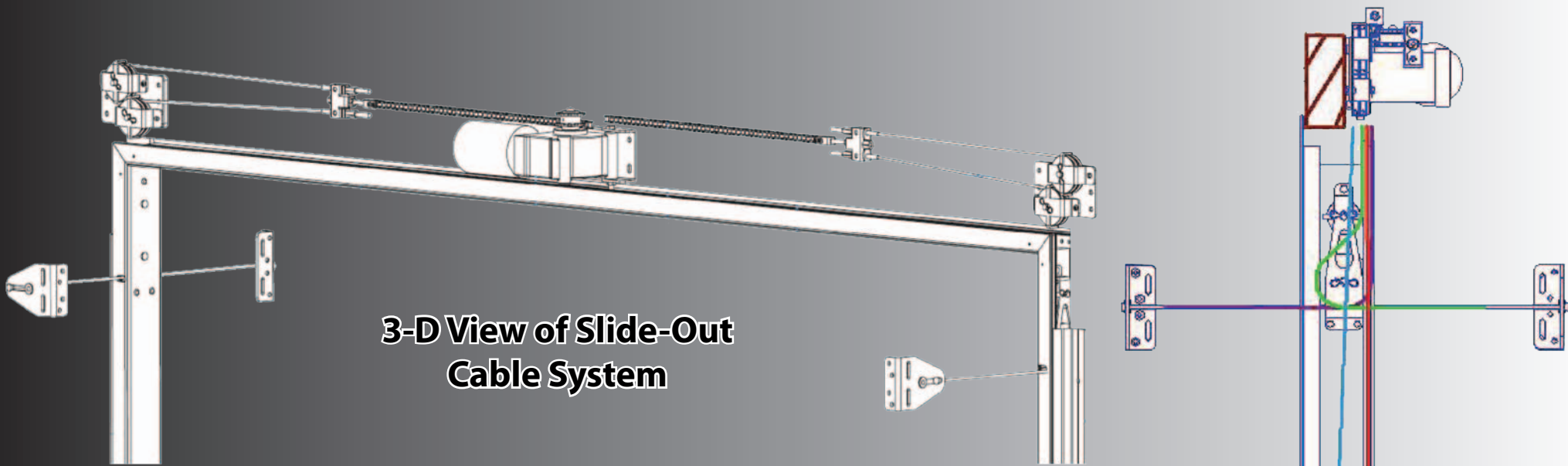

3-D View of Slide-Out Cable System

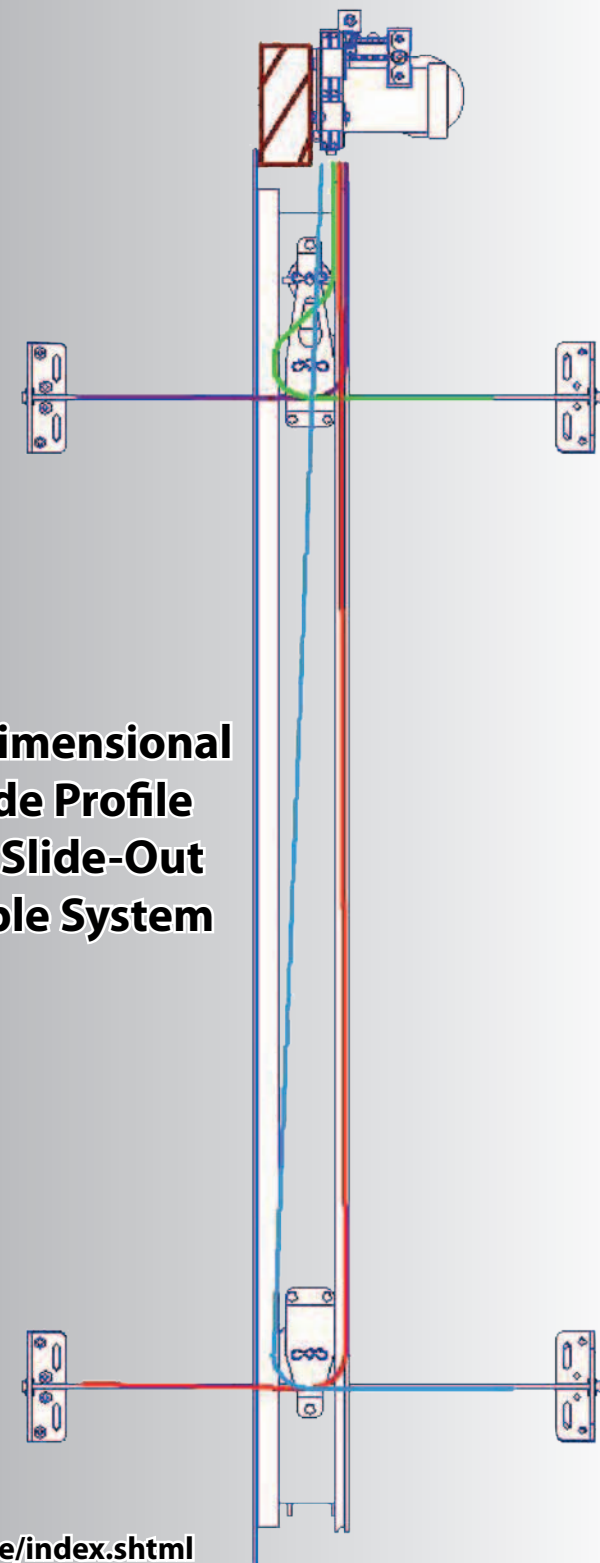

1- Dimensional Side Profile Of Slide-Out Cable System

10 Reasons Why... Accu-Slide

1. Above floor design means more storage area for your RV
2. Lightweight design promotes fuel savings
3. High strength stainless steel aircraft cable is used for control
4. Cable control at all 4 room corners helps stop leaks
5. Working components are in your RV, safe from the elements
6. Locking motor secures room in or out to help stop leaks
7. Above floor design minimizes maintenance requirements
8. A clean system - no leaky hydraulic lines or greasy drives
9. Smooth, quiet room movement - no jumping or jerking
10. It's built in the U.S.A. and backed by BAL since 1972

Construction Cutaway

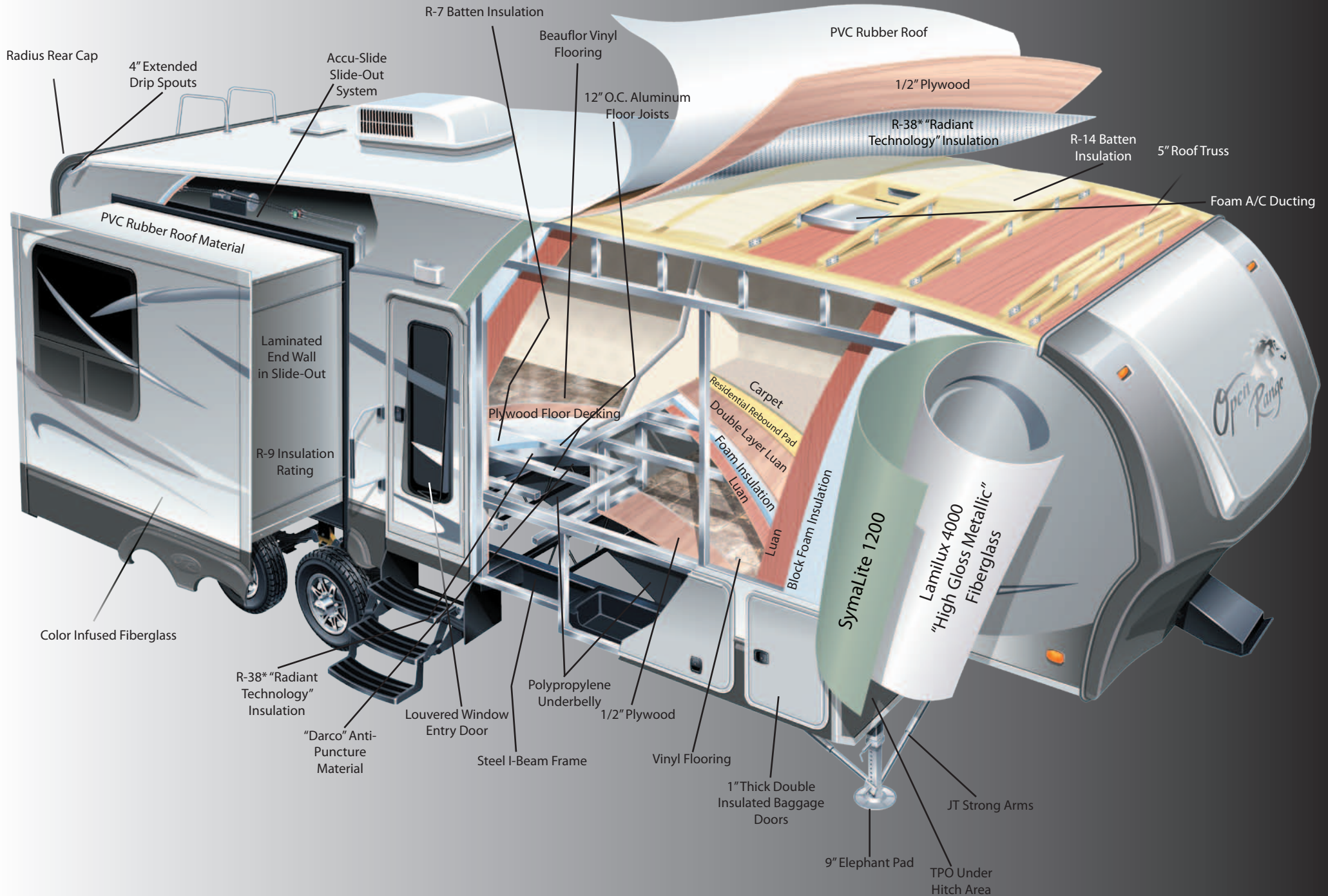

Interior Construction

**100 LB. FULL EXTENSION
DRAWER GUIDES**



**RUSSIAN BIRCH DOVETAILED
DRAWER CONSTRUCTION**



HARDWOOD CABINET CONSTRUCTION



- Hardwood Cabinet Doors and Drawer Faces
- Lumber Core Stiles
- Mortis & Tenon Joints
- Residential Style Hidden Hinges

HIDDEN HINGES



CABINET CONSTRUCTION



- Face Frames are Tube Drilled and Screwed for Maximum Strength

- Elegant Euro-Style Spring Loaded Hardware
- Keeps Doors Closed Tightly
- Fully Adjustable to Customize Fit

7-LAYER BEAUFLOR VINYL FLOORING

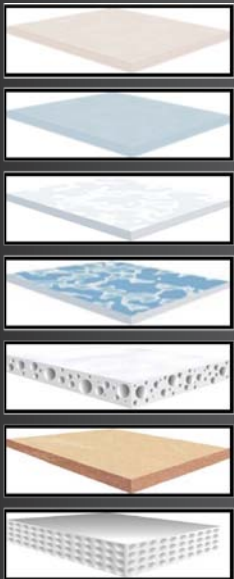

SOLID WOOD SLIDEOUT FASCIAS



Exterior Construction

1/2" PLYWOOD ROOF DECKING

- 1/2" Thick Plywood
- 350 lb. Rating
- Constructed with Real Plywood
- More Durable
- Better Quality



PVC RUBBER ROOF MATERIAL

- Ultra Violet Resistant
- No Streaking or Chalking
- No Reconditioning Needed
- 30% Lighter Weight Than EPDM Rubber Roof
- Self Extinguishing
- Can be Recycled



SYMALITE 1200 SIDEWALL SUBSTRATE

- Man-Made Composite Technology
- 125% More Puncture Proof
- Additional Insulator
- Noise Reduction
- Moisture, Mold, & Swell Resistant
- Provides the Best Possible Bond with Fiberglass

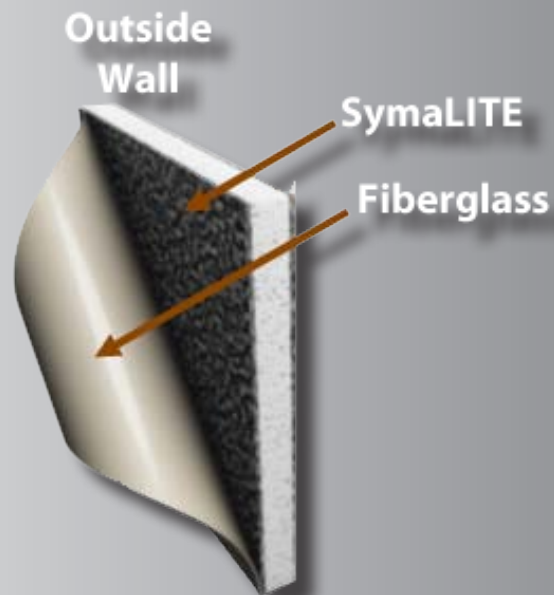

- At 30% Compression the PVC Foam Seal is 100% Waterproof
- Permanent Seal that Won't Deteriorate
- Provides a Complete and Consistent Seal Throughout

PVC FOAM SEALS



Exterior Features

15,000 BTU A/C
w/ "Quick Cool" Feature

4" Extended
Drip Spouts



Frameless Windows

3 Function
Wireless Remote



MAXAIR
VENT CORP

Carefree
Power Awning

50 Amp
Service with
LED Power
Indicator



Contoured Front Cap For
Tighter Turning Radius

(Optional) Air Ride
Pin Box

Dexter EZ-Flex Suspension



Extended Skirt Metal
Frame Shield

Metal Slam Latch
Baggage Doors



Slideout LP Trays
(80 lbs Capacity)

JT Strong Arm Stabilizers



Leveling System
Control Panel



Outside Convenience
Center

DEXTER AXLE

Four Seasons Protection Package



- Atwood High Performance Furnace
- Heated Storage Area
- Insulated Slide Floors
- Vented Attic
- Double Insulated Baggage Doors
- Digital Thermostat
- Heated Underbelly
- Heated and Enclosed Dump Valves
- R-38 Roof Insulation*
- R-38 Floor Insulation* (above tanks)
- R-38 Below Holding Tanks*
- R-9 Sidewalls

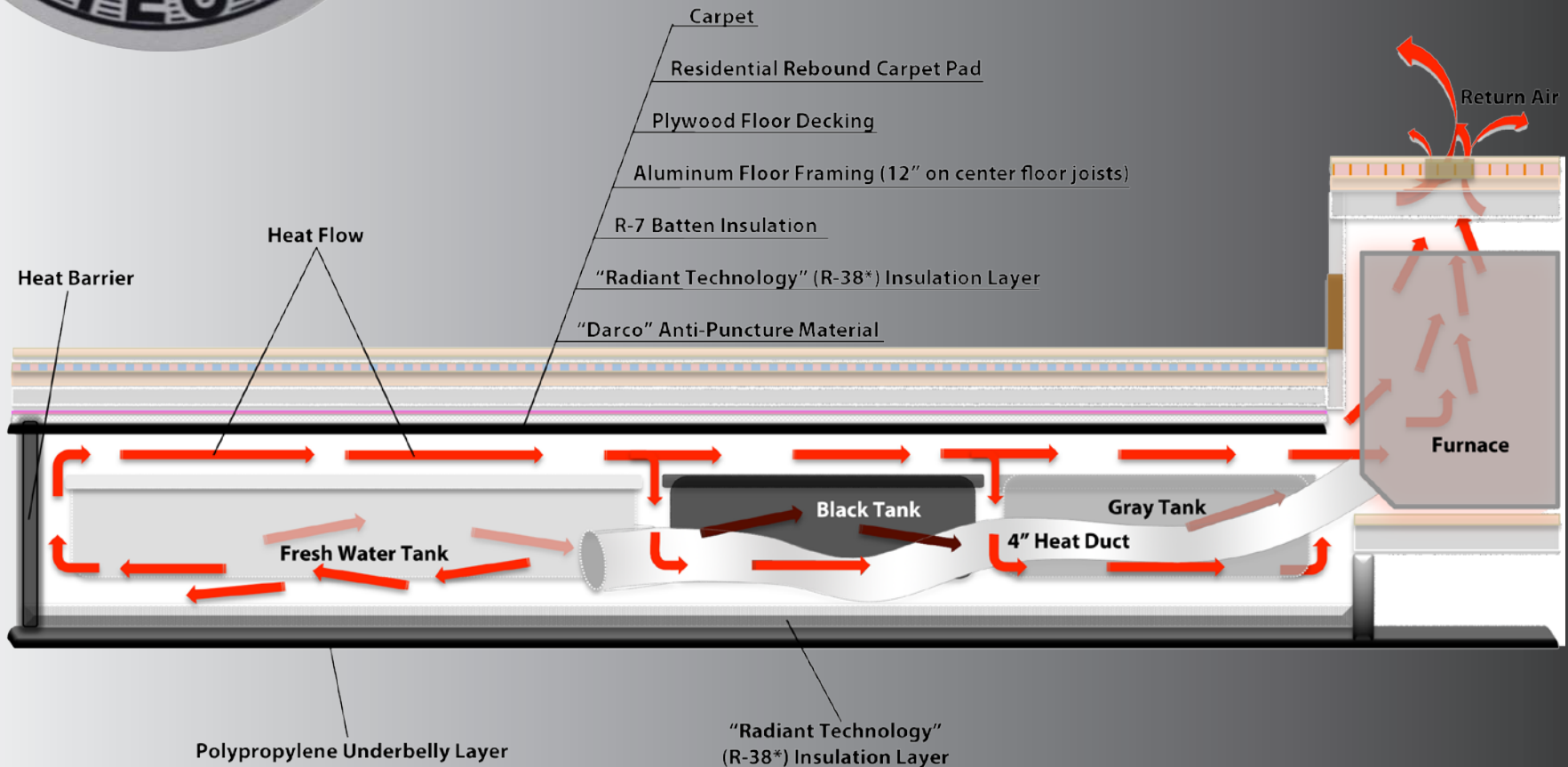

Executive Living Package

Interior:

- Large 8cu ft Refer (Open Range Only)
- 10gal Quick Recovery Water Heater
- 15,000 BTU A/C w/"Quick Cool" Feature
- Corian Countertops in Galley
- "Fantastic Fan" in Kitchen
- Residential Hide-a-Bed Sofa
- "Comfort Cloud" Pillowtop Mattress
- Flip Out Sink Trays
- Pull-Out Pantry (Open Range Only)
- Residential Pantry (Residential Only)
- Ladder Chair

Exterior:

- Power Awning
- "MaxxAir" Vent Cover



Entertainment Package

- 40" LCD TV (N/A 345RLS, 359RKS, 413RLL)
- 19" LED TV w/Portable Swing Arm
- 12v CD/DVD/MP3/AM/FM/iPod/USB Stereo
- Cable Hook-Up
- Satellite Hook-Up
- Dual Speakers in Pass-Thru Storage Area
- Digital TV Antenna and Booster



Equipped with
**JACK® DIGITAL
HDTV ANTENNA**
with Integrated SureLock
TV Signal Meter!

- No need to crank up or down and is always ready for travel
- Built-in signal meter for fast and accurate antenna pointing
- Full 360° rotation allows for precise antenna pointing with no "dead spot"

A PRODUCT OF
ICE KING CONTROLS



Decors

Lifelong



Sedonna



Pinto



Interior Standards

- High output Range w/Igniter and Large 22" Oven
- 30" OTR Convection Microwave (Residential Only)
- Hardwood Raised Panel Glazed Cabinet Doors
- Full Extension Drawer Guides
- Fluorescent Light in Galley
- Ceiling Fan
- Washer/Dryer Prep
- Skylight above Shower
- Porcelain Toilet
- Triple Mullion Closet Doors (Residential Only)
- One Piece Fiberglass Shower (Residential Only)
- EZ Access Entry Light
- Glass Vessel Lavatory Bowl Sink
- Glass Shower Door & Surround
- High-End Shower Fixture
- Pull-Out Waste Basket
- Dovetailed Drawer Sides
- 30" OTR Microwave (Open Range Only)
- Stainless Steel Sink
- 23 cu ft Refer (Residential Only)

**TWO-YEAR LIMITED
TRANSFERABLE WARRANTY**

Exterior Standards

- Contoured Front Cap for Superior Turning Radius
- Battery Disconnect
- "Dexter" E-Z Flex Suspension
- Triple 9" Entry Steps
- Extended Drain Spouts
- Wired and Framed for 2nd A/C in Bedroom
- 16" Aluminum Wheels
- Dual LP Slide Trays
- Auto-Leveling and Stabilizing System
- Full View Vented Entrance Door
- LED Taillights
- Exterior Convenience Center
- "Dexter" Wide Stance E-Z Lube Axles
- Radial Tires
- Dual Outdoor Security Lights
- Large Assist Grab Handle
- Telescopic Sewer Hose
- Removable Rear Ladder
- Rear Fiberglass Cap
- Metal Slam Latch Doors
- 3 Function Wireless Remote System

PURCHASE LOCALLY

Open Range RV strongly encourages our retail customers to purchase from their local dealership whenever possible due to the following reasons:

1) Our Dealers are, as a rule, independently owned and operated businesses. Outside of those customers they personally sold products to, they are not obligated to perform warranty service on Open Range RV products that were purchased elsewhere. There may be an occasion that the customer will be required to return to the point of purchase to satisfy warranty requirements.

2) Although many dealerships will eventually service products not purchased at their dealership, they will usually take care of their customers and other Open Range RV customers who are traveling away from their local dealer as a priority.

3) Local purchases allow a customer to establish a relationship with a dealer close to home. This relationship provides the customer with a convenient location for service and support from a "local" professional.

4) The opportunity for a thorough PDI (Pre Delivery Inspection) and product orientation is an additional benefit of buying from a local dealer. The opportunity for refresher courses or the ability to get questions answered more promptly is another additional benefit of buying from a local dealer.

5) For our Canadian customers, there are also requirements which must be met to bring an RV purchased out of the country to their home. Although not impossible, these requirements may involve such things as additional inspections, certifications, taxes and fees. The local Canadian Dealer is a professional at meeting these requirements.

6) Open Range's goal is for all RV Owners to fully enjoy their RV experience. In light of this goal, and considering the advantages of buying locally, we encourage you to be thorough when determining what product to purchase and which dealer to purchase it from as both are key to your ultimate satisfaction.

Your Open Range Dealer:



Open Range RV Company 3195 N. St. Rd. 5 Shipshewana, IN 46565

Phone: (260) 768-7771 - www.OpenRangeRV.com

Due to continual research and advances, manufacturer reserves the right to change specifications, design, price, and equipment without notice, and assumes no responsibility for any error in the literature. Some items shown are not included as standard or optional equipment

©2011 Open Range RV Company, Shipshewana, Indiana