

# Thunder Jet



PRODUCT & MODEL GUIDE

# Thunder Jet

Established in Clarkston Washington in 1981, Thunder Jet began with founder Darrell Mills heading up sales, his wife Liana doing the books, and employing 1 welder, rig tech and painter. In their first year they produced just 5 boats, but that is all it took and Thunder Jet was the latest industry buzz.

30 Years and over 10,000 boats later, Thunder Jet now holds the position as one of the most successful Aluminum boating companies to ever exist, a direct result of their superior product and continued efforts improve and adapt to the ever changing boating community's needs.

Today Thunder Jet is the most advanced heavy gauge aluminum boat builder in North America. By utilizing and investing in the newest and best in equipment, people, and practices, Thunder Jet Boats are the highest quality, best finished, and best valued boats available today.

Our commitment is to continue finding and investing in better ways to make high quality boats affordable, fuel efficient, resilient and appealing so that more people can enjoy the experiences that boating can offer.

## THUNDER JET FACTS



- Thunder Jet manufactures its own hull components using the latest in computer controlled cutting and forming equipment. This ensures precision, quality, and the best performance possible.
- Thunder Jet employs top craftsmen; in fact our welding team alone has over 300 years of combined experience.
- Thunder Jet manufactures most of its own components, like seats, windows, and tops. This allows us to provide the best quality, style, fit and finish in the industry.
- Thunder Jet hulls are backed by a lifetime transferable warranty.

### THE HULL FACTS... SIMPLY BUILT BETTER

Outboard Hull

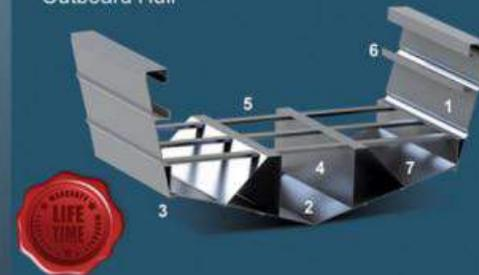

1. One piece side walls
2. One piece bottom
3. Sides and bottom overlapped and double welded to create triangular structured reverse chine from bow to stern
4. Full depth compound angle stringer reinforces the hull and forms part of the floor
5. Lateral bracing welded in every 18" on center further increasing strength
6. Full length side trays reinforce sides
7. Hull stiffeners welded to bottom further increasing strength

Inboard Hull

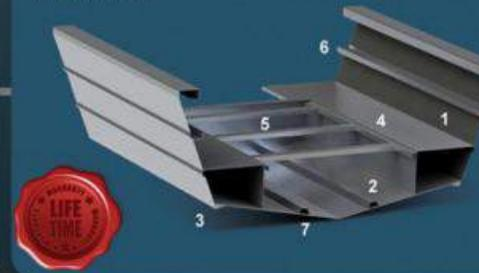

650 Ton 26' CNC Acurpress



34' CNC controlled Onsrud router table



**OUTBOARD**

**INBOARD**

V-186 ECO OB



LANDING CRAFT



LUXOR OFFSHORE



185-EXPLORER



ALEXIS OFFSHORE



180 ECO JET



LUXOR JET



RIO CLASSIC



LUXOR OB



TJ PILOT



BULLDOG



ALEXIS



MAXIM CLASSIC



NORTHERN EDITION ENVOY



ALEXIS CLASSIC



**OFFSHORE**

# MODEL OVERVIEW



# PG 04 V-186 ECO

# SPECIFICATIONS



Length	18'6" / 5.6m
Beam	86" / 2.18m
Height of Sides	31" / 78.7cm
Bottom Width	66" / 1.68m
Approx. Dry Weight	1170 lbs. / 531kg
Deadrise	14°
Fuel Capacity	32 USG / 121L
Transom Height	20" / 51cm
Max. HP	115 HP
<b>Aluminum Thickness / Alloy</b>	
Side	0.125", 3.17mm / 5052
Bottom	0.160", 4.06mm / 5086
Transom	0.160", 4.06mm / 5052

<b>Base engine</b>	
90 H.P. Long shaft	
Side mount controls	
Tachometer	
Optional power 70 - 115 H.P.	
Note: Does not include prop	

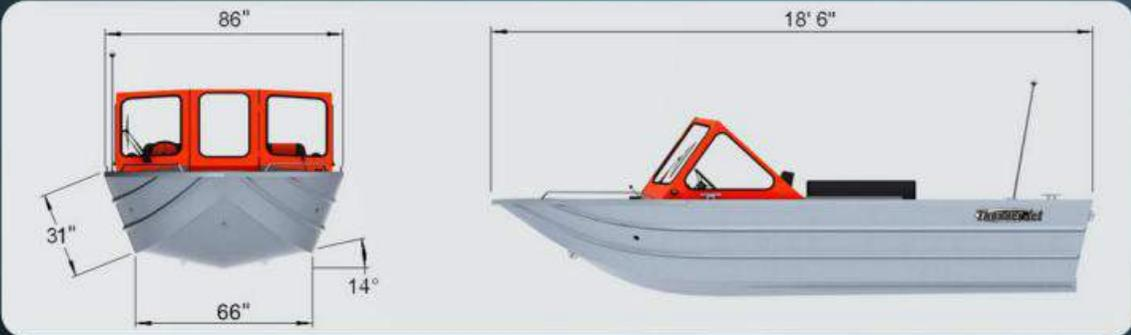

## PERFORMANCE AND VALUE REDEFINED

Packed with standard features the 186-ECO offers the serious sportsman maximum deck space with the forward mounted windshield and intelligent splash well design. Built with our industry exclusive Tri-structure reverse chine and a delta keel bottom, getting you the most out of outboard performance with a safe, dry ride.



# SPECIFICATIONS

# 185 EXPLORER PG 05

Length	18'5" / 5.6m
L.O.A.	20'5" / 6.2m
Beam	96" / 2.43m
Height of Sides	34" / 86.3cm
Bottom Width	72" / 1.83m
Approx. Dry Weight	1300 lbs. / 590kg
Deadrise	16°
Fuel Capacity	48 USG / 180L
Maximum HP	150 hp
Transom Height	34" / 78.7cm
Motor Length XL	25" / "XL"
<b>Aluminum Thickness / Alloy</b>	
Side	0.125", 4.82mm / 5052
Bottom	0.190", 4.82mm / 5086
Transom	0.190", 4.82mm / 5052
<b>Base engine</b>	
90 H.P. Extra Long shaft	
Side mount controls	
Tachometer	
Optional power 90 - 150 H.P.	
Note: Does not include prop	

Images shown may include optional features



## BEST IN CLASS VALUE

The Explorer is big on value, built with the no nonsense fishman in mind, its extra wide, deep, and made to tame big water. With its full width offshore mount, the Explorer offers more aft deck space than any comparable model. Perfect for those weekend fishing trips with family and friends.

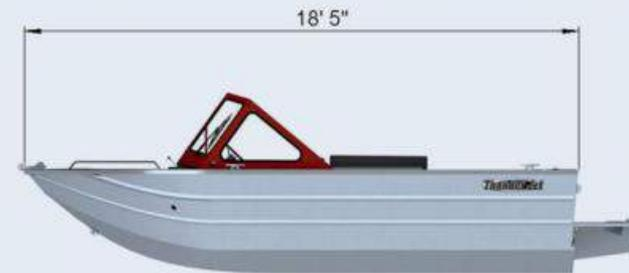
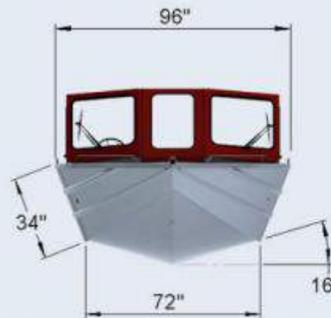

# PG 06 LUXOR OB

## SPECIFICATIONS



Length	20' / 6.1m
L.O.A.	22' / 6.7m
Beam	96" / 2.4m
Height of Sides	34" / 86.4cm
Bottom Width	72" / 1.83m
Approx. Dry Weight	1800 lbs. / 816.5kg
Deadrise	16°
Fuel Capacity	48 USG / 180L
Max. HP	225 HP
Transom Height	34" / 86.4cm
Motor Length XL	25" / "XL"
<b>Aluminum Thickness / Alloy</b>	
Side	0.125", 3.17mm / 5052
Bottom	0.190", 4.82mm / 5086
Transom	0.190", 4.82mm / 5052
<b>Base engine</b>	
115 H.P. Extra Long shaft	
Side mount controls	
Tachometer	
Optional power 115 - 225 H.P.	
Note: Does not include prop	



### THE STANDARD IN STYLE FORM & FUNCTION

The Luxor Outboard is our most popular model. It's equipped with all the right standard features and available with a half, 3/4, or full hard top. The Luxor has set the standard for 20' aluminum outboard boats for over 20 years. Packed with all of the features a sportsman needs, the Luxor is the bench mark in the industry.

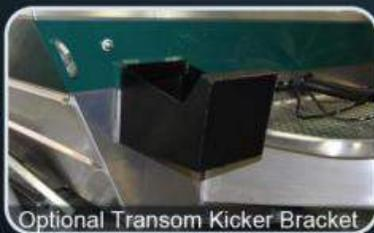

# SPECIFICATIONS

# LANDING CRAFT 20' - 26' PG 07

Length	20' / 6.1m - 22' / 6.7m
Beam	102" / 2.6m
Height of Sides	34" / 86.3cm
Bottom Width	90" / 2.28
Approx. Dry Weight	2200 lbs. / 998kg
	2300 lbs. / 1043kg
Deadrise	16°
Fuel Capacity	48 USG / 180L
Maximum HP	225 HP / 250 HP
Transom Height	34" / 86.3cm
Cargo Capacity	1500 lbs. / 680kg
	1900 lbs. / 862kg
<b>Aluminum Thickness / Alloy</b>	
Side	0.190", 4.82mm / 5052
Bottom	0.190", 4.82mm / 5086
Transom	0.250", 6.35mm / 5052

Images shown may include optional features



**i** See our website for exclusive Landing Craft Options



## THE ULTIMATE UTILITY BOAT

Whether you are building your dream cabin, packing dive gear, or casting off for a big game adventure, we have the perfect answer for your cargo hauling needs. The Landing Craft can be configured in cabin, center and dual console models giving you the ultimate in versatility.



Optional Folding Seats and Pedestal Table

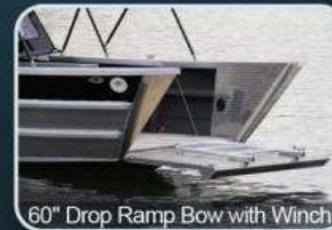

60" Drop Ramp Bow with Winch



Optional Bow Ladder

STANDARD FEATURES

	V186 ECO	185 EXPLORER	LUXOR OB	LANDING CRAFT
1/3 Hull side paint	Opt.	Opt.	Std.	Opt.
All LED Navigation Lights Package	Std.	Std.	Std.	Std.
Battery holder with group 24 marine battery	Std.	Std.	Std.	Std.
Bench seats with removable back rest	Opt.	Opt.	Std.	Opt.
Color matched painted dash and windshield	Std.	Std.	Std.	Std.
Color matched interior upholstery selection	Std.	Std.	Std.	Std.
Color matched Under dash and transom courtesy lights	Std.	Std.	Std.	Std.
Crystal cap side logo	Std.	Std.	Std.	Std.
Cup holders for driver and passenger	Std.	Std.	Std.	Std.
Diamond tread bow step with storage	Std.	Std.	Std.	N/A
Double walled recessed diamond tread self-bailing bow	Std.	Std.	Std.	N/A
Driver and Passenger deluxe bucket seats with swivels	Std.	Std.	Std.	Std.
Drop curtain for folding top canvas	Opt.	Opt.	Std.	Opt.
Electric 1250 GPH bilge pump with auto float switch	Std.	Std.	Std.	Std.
Electric Horn	Std.	Std.	Std.	Std.
Exclusive tri-structure full length reverse chine	Std.	Std.	Std.	N/A
Floor storage compartment	N/A	N/A	Std.	N/A
Full dash instrumentation including:	Std.	Std.	Std.	Std.
12V power point, Fuel gauge, Hour meter, Tachometer	Std.	Std.	Std.	Std.
6 rocker switches with 3 additional accessory switches	Std.	Std.	Std.	Std.
Full length welded side storage trays	Std.(2)	Std.(2)	Std.(2)	Std.(2)
Full length engineered compound angle stringers	Std.	Std.	Std.	Std.
Full length formed in hull side stiffeners	Std.	Std.	Std.	Std.
Fully welded heavy duty keel guard	Std.	Std.	Std.	Std.
Heavy duty square tubing folding top with side windows and travel boot	Std.	Std.	Std.	Opt.
Heavy duty external set 1/4" safety glass windows	Std.	Std.	Std.	Std.
Large 2" fully welded bow scuppers	Std.	Std.	Std.	N/A
Lexan shatter proof center walk through window	Std.	Std.	Std.	Std.*

	V186 ECO	185 EXPLORER	LUXOR OB	LANDING CRAFT
Locking glove box	Opt.	Opt.	Std.	Std.*
Locking interior transom access hatches	N/A	Opt.	Std.	N/A
Marine grade carpeted sound deadening side walls	Std.	Std.	Std.	Opt.
Pantographic self-parking windshield wipers	1	1	1	1
Performance lifting strakes	2	2	4	4
Premium marine wiring harness with water tight connections	Std.	Std.	Std.	Std.
Premium marine grade vinyl decking	Std.	Std.	Std.	Std.
Quick connect auxiliary engine fuel supply	Opt.	Opt.	Opt.	Opt.
Safety hub power distribution block	Std.	Std.	Std.	Std.
Self-draining bow locker	Opt.	Opt.	Opt.	N/A
Single piece formed sides and bottom	Std.	Std.	Std.	Std.
Stainless steel rubber coated steering wheel	Std.	Std.	Std.	Std.
Transom battery shelf	N/A	Opt.	Opt.	N/A
Transom fish locker / storage box	N/A	Std.	Opt.	Opt.
Under dash storage compartments	N/A	N/A	N/A	N/A
Upswept bow design	N/A	N/A	N/A	N/A
Welded 5 piece walk-through windshield	Std.	Std.	Std.	Std.*
Welded 8" cleats	5	5	5	6
Welded anchor roller	Opt.	Opt.	Opt.	N/A
Welded 3" bow rails	Std.	Std.	Std.	Opt.
Welded 6" wraparound stern rails	Opt.	Opt.	Std.	Opt.
Welded downrigger mounting pads	Opt.	Opt.	Std.	Opt.
Welded External motor bracket with diamond tread decking	N/A	Std.	Std.	Std.
Welded passenger safety grab rail	Std.	Std.	Std.	Std.*
Welded high mount windshield safety grab rails	Opt.	Opt.	Std.	Std.*
Welded through hull fittings	Std.	Std.	Std.	Std.
Custom fit welded frame galvanized bunk trailer	Std.	Std.	Std.	Std.

\*Not applicable to Center Console model



### Standard Single Stage Colors

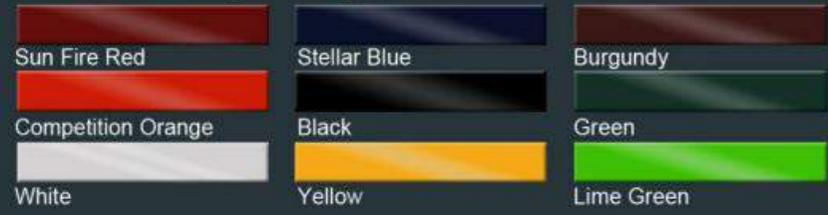

### Custom Metallic Base/Clear Colors



Put together your own customized Thunder Jet on our build a boat page at [www.thunderjet.com/build-a-boat](http://www.thunderjet.com/build-a-boat)

## AVAILABLE OPTIONS

**!** Certain options may not be available to certain models

<b>Motor Options</b>	<b>Stern</b>	Competition Orange	Yellow	Tilt helm	Team logo color scheme package
Yamaha	Transom fish box			Bench seat locking drawers (ea)	<b>Hull Fab. Options</b>
Suzuki	Aft storage bench	<b>Interior Color</b>		Stern corner folding seats (each)	Platform kicker bracket (welded)
Mercury	Swim step	Dark Interior		Side rod holders	Net Holder
<b>Kickers</b>	Grab rail	Light Interior		Quick connect kicker fuel supply	Top pole holders (4)
Kicker Control at Helm	3 step telescoping ladder	Color matched interior		6" Stern rails with D/R mounts	Hard Top side pole holders (4)
Motor Tie Bar	(requires swim step)	<b>Top Color</b>		Additional 12 Volt plug	3/4 platform with kicker bracket
Kicker Motor Install	Additional D/R pads x2	Light Gray	Black	Detachable Bow ladder	Full platform with kicker bracket
Suzuki DF9.9THL	<b>Upholstery / Canvas</b>	Dark Gray	Tan	LED Dome light	Weld on transom kicker bracket
Yamaha T9.9LPHA	Stern cover	<b>Additional Options</b>		LED Flood light	Transom riser for OB jet
Mercury 9.9 ELHPT BF Pro	Folding top w/ side curtains	Garmin GPS / Fish finder		24" LED light bar (hard top only)	Delete transom splashwell
Honda BF10D3LHT	Mooring cover	Stereo w/ 4 spkrs & remote		<b>Paint</b>	Locking Glove Box
<b>Kicker options</b>	Camper cover	Dual Bilge Pumps		Painted bow	Wake Tower
Kicker control at helm	Towing bra	Dual batteries		Painted full transom	Saddle cut transom
Kicker tie bar	Snap in carpet	Wash down w/ hose receptical		Painted gunnels	Under floor storage
Kicker installation	Privacy curtain	Passenger wiper		Premium Paint (see color chart)	<b>EZ Loader Trailer</b>
<b>Bow</b>	Mooring cover	Wash down		Premium Paint w/ Hard Top	Chine load guides
Closed bow	Top down towing cover	2 Bank automatic battery charger		1/3 Hull side paint	Surge drum brakes
Bow locker w/ drain	Towing bra	Bow live well kit		Painted bow	Swing tongue
Bow live well kit	Drop Curtain	Stern livewell kit		Painted full transom	Electric Brakes
Anchor roller w/ jamb cleat	4 Panel EZ access front canvas	Arm rests (per pair)		Painted gunnels	Surge disc brakes
Detachable Bow Ladder	Stern cover w/ window	Suspension seats on swivels		Sharkhide hull protectant	Brake flush kit
<b>Top</b>	<b>Color Scheme</b>	Bench seat locking drawers (ea)		Shrink wrap	Spare Tire w/ mount
1/2 Hard Top	Sun Fire Red	Swivel chairs on rear bench seats		Custom graphics package	Gateway trailer upgrade
3/4 Hard Top	Burgundy	Bed rails		Polished bow and stern rails	Powder coated trailer
Full Hard Top	Stellar Blue	Heated seats (each)		Polished wake tower	
		Side bench seats			

# LUXOR OB OS

## SPECIFICATIONS

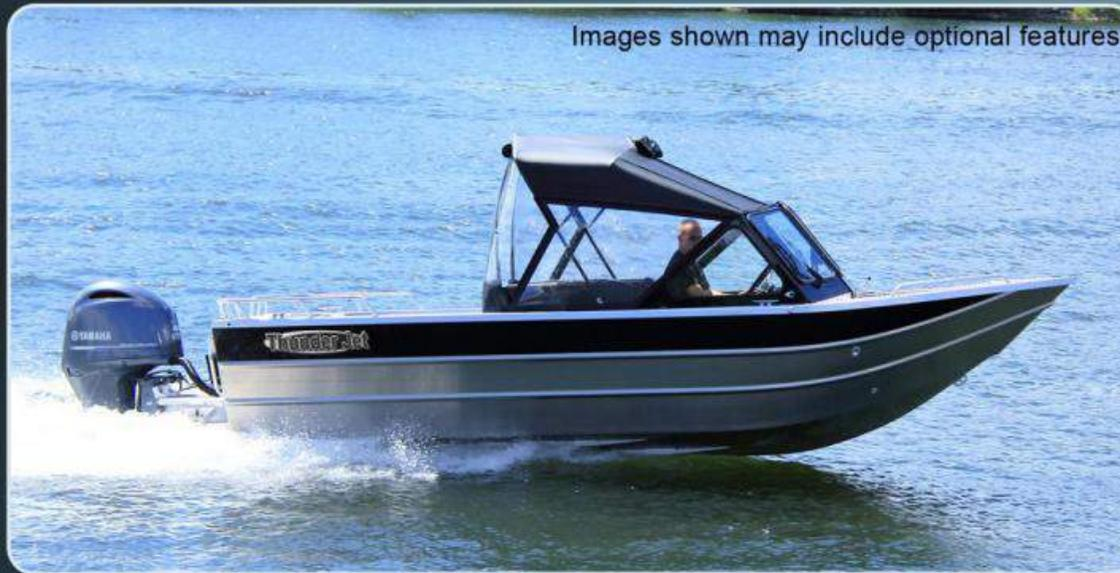

Length	20' / 6.1m
L.O.A	22' / 6.7m
Beam	96" / 2.44m
Height of Sides	38" / 96.5cm
Bottom Width	78" / 2m
Approx. Dry Weight	2150 lbs. / 975kg
with 1/2 Hard Top	2575 lbs. / 1168kg
with Full Hard Top	2625 lbs. / 1190kg
Deadrise	Progressive 18"
Fuel Capacity	48 USG / 180L
Max. HP	250 HP
Transom Height	38" / 96.5cm
Motor Length XL	25" / "XL"
<b>Aluminum Thickness / Alloy</b>	
Side	0.125", 3.17mm / 5052
Bottom	0.190", 4.82mm / 5086
Transom	0.250", 6.35mm / 5052
<b>Base engine</b>	
150 H.P. Extra Long shaft	
Side mount controls	
Tachometer	
Optional power 150 - 250 H.P.	
Note: Does not include prop	



### UNCOMPROMISED OFFSHORE PERFORMANCE

Everything about the Luxor Offshore has the serious fisherman in mind, from the extra deep sides to the extra rod trays and it's swept deep "V" hull. Whether you are taking the Luxor OS 30 miles offshore or across the lake, you and your family will get there in safety and style. Add extra protection and style with any one of three hard top options.





Optional Full Side Paint and 3/4 Hard Top



Optional 1/2 Hard Top



Standard Transom Hatches



Standard Light Interior Seats



Standard Under Dash Storage



Standard Large Bench Seats



Optional Hard Top and LED Interior Lighting

# PG 12 ALEXIS OB OS

## SPECIFICATIONS

Images shown may include optional features



Length	22' / 6.7m
L.O.A.	24' / 7.36m
Beam	102" / 2.6m
Height of Sides	40" / 101.6cm
Bottom Width	84" / 2.13m
Approx. Dry Weight	2500 lbs. / 1134kg
with 1/2 Hard Top	2950 lbs. / 1338kg
with Full Hard Top	3100 lbs. / 1406kg
Deadrise	Progressive 18°
Fuel Capacity	80 USG / 302.8L
Maximum HP	350 hp
Transom Height	40" / 101.6cm
Motor Length XL	25" / "XL"
<b>Aluminum Thickness / Alloy</b>	
Side	0.125", 3.17mm / 5052
Bottom	0.190", 4.82mm / 5086
Transom	0.250", 6.35mm / 5052
<b>Base engine</b>	
F200XB Extra Long shaft	
Side mount controls	
Tachometer	
Optional power 200 - 350 H.P.	
Note: Does not include prop	

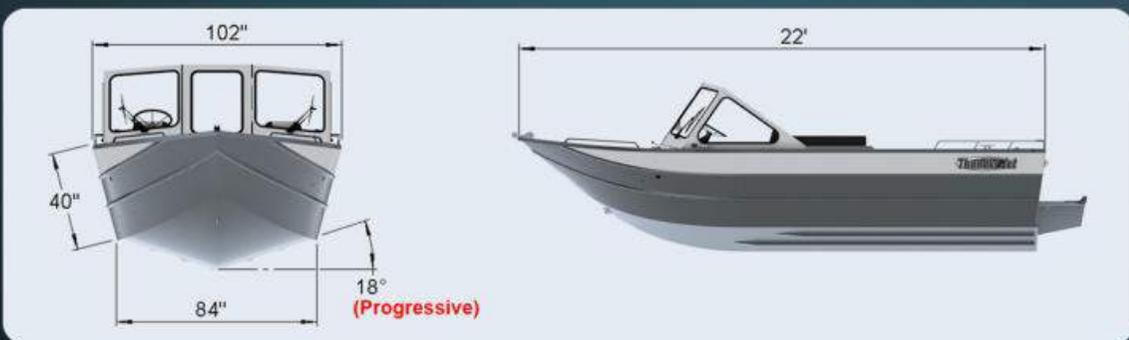

### WHEN ONLY THE BEST WILL DO...

The Alexis Offshore is our deepest, widest, best riding, big water hull. The Alexis is the Big Daddy of fishing machines and can easily accommodate the largest group of friends. With options like a full hard top and alaskan bulkhead it can be outfitted to fill all your needs.

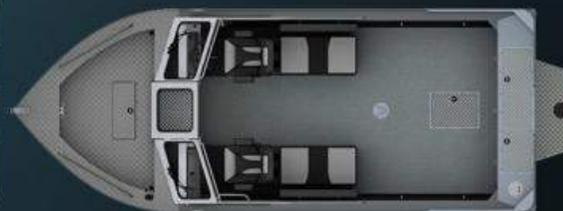



Pewter Color Matched Interior



Hard Top Side Storage Tray



Dash Design

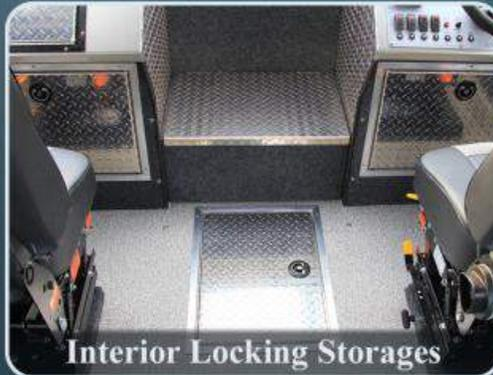

Interior Locking Storages



Standard Transom Courtesy Lights



Optional Full Hard Top

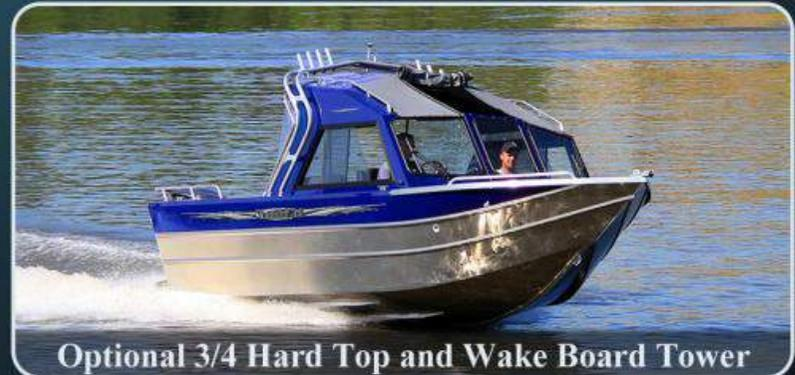

Optional 3/4 Hard Top and Wake Board Tower

STANDARD FEATURES

	LUXOR	OB	OS	ALEXIS	OB	OS
1/3 Hull side paint	Std.			Std.		
All LED Navigation Lights Package	Std.			Std.		
Battery holder with group 24 marine battery	Std.			Std.		
Bench seats with removable back rest	Std.			Std.		
Color matched painted dash and windshield	Std.			Std.		
Color matched interior upholstery selection	Std.			Std.		
Color matched Under dash and transom courtesy lights	Std.			Std.		
Crystal cap side logo	Std.			Std.		
Cup holders for driver and passenger	Std.			Std.		
Diamond tread bow step with storage	Std.			Std.		
Double walled recessed diamond tread self-bailing bow	Std.			Std.		
Driver and Passenger deluxe bucket seats with swivels	Std.			Std.		
Drop curtain for folding top canvas	Std.			Std.		
Electric 1250 GPH bilge pump with auto float switch	Std.			Std.		
Electric Horn	Std.			Std.		
Exclusive tri-structure full length reverse chine	Std.			Std.		
Floor storage compartment	Std.			Std.		
Full dash instrumentation including:	Std.			Std.		
12V power point, Fuel gauge, Hour meter, Tachometer	Std.			Std.		
6 rocker switches with 3 additional accessory switches	Std.			Std.		
Full length welded side storage trays	Std.(4)			Std.(4)		
Full length engineered compound angle stringers	Std.			Std.		
Full length formed in hull side stiffeners	Std.			Std.		
Fully welded heavy duty keel guard	Std.			Std.		
Heavy duty square tubing folding top with side windows and travel boot	Std.			Std.		
Heavy duty external set 1/4" safety glass windows	Std.			Std.		
Large 2" fully welded bow scuppers	Std.			Std.		
Lexan shatter proof center walk through window	Std.			Std.		

	LUXOR	OB	OS	ALEXIS	OB	OS
Locking glove box	Std.			Std.		
Locking interior transom access hatches	Std.			Std.		
Marine grade carpeted sound deadening side walls	Std.			Std.		
Navigation lights package with all around light	Std.			Std.		
Pantographic self-parking windshield wipers	2			2		
Performance lifting strakes	4			4		
Premium marine wiring harness with water tight connections	Std.			Std.		
Premium marine grade vinyl decking	Std.			Std.		
Quick connect auxiliary engine fuel supply	Std.			Std.		
Safety hub power distribution block	Std.			Std.		
Self-draining bow locker	Std.			Std.		
Single piece formed sides and bottom	Std.			Std.		
Stainless steel rubber coated steering wheel	Std.			Std.		
Transom battery shelf	Std.			Std.		
Transom fish locker / storage box	Std.			Std.		
Under dash storage compartments	Std.			Std.		
Upswept bow design	Std.			Std.		
Welded 5 piece walk-through windshield	Std.			Std.		
Welded 8" cleats	5			5		
Welded anchor roller	Std.			Std.		
Welded 3" bow rails	Std.			Std.		
Welded 6" wraparound stern rails	Std.			Std.		
Welded downrigger mounting pads	Std.			Std.		
Welded External motor bracket with diamond tread decking	Std.			Std.		
Welded passenger safety grab rail	Std.			Std.		
Welded through hull fittings	Std.			Std.		
Custom fit welded frame galvanized bunk trailer	Std.			Std.		



### Standard Single Stage Colors

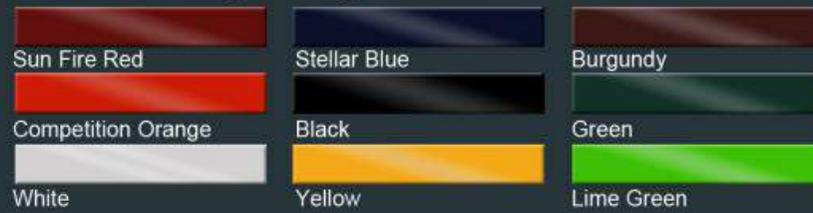

### Custom Metallic Base/Clear Colors



Put together your own customized Thunder Jet on our build a boat page at [www.thunderjet.com/build-a-boat](http://www.thunderjet.com/build-a-boat)

## AVAILABLE OPTIONS

**i** Certain options may not be available to certain models

#### Motor Options

Yamaha	Suzuki
Mercury	Honda
Verado	

#### Hull Spec. Options

Extended length 1'
0.250 bottom
70 gallon tank (21' Luxor OS)
110 gallon tank (23' Alexis OS)

#### Bow

Closed bow
Detachable bow ladder

#### Top (incl slider windows)

1/2 Hard top
3/4 Hard top
Full Hard top
Alaskan bulkhead (21')
Extended hard top w/ interior drop curtain

#### Stern

Additional D/R mounts x2
Aft storage bench
Swim step
Grab rail
Swim ladder

#### Upholstery / Canvas

Stern cover
Mooring cover
Top down tow cover
Camper cover
Towing bra
Snap in carpet
Privacy curtain
Stern cover w/ window
4 Panel EZ access front canvas

#### Color Scheme

Sun Fire Red
Black
Green
Burgundy
White
Yellow
Stellar Blue
Competition Orange

#### Interior Color

Dark Interior
Light Interior
Color matched interior

#### Top Color

Light Gray
------------

#### Black

Dark Gray
Tan

#### Additional Options

Garmin GPS / Fish finder Combo
Stereo w/ 4 spkrs & remote
Dual bilge pumps
Dual batteries
2 Bank automatic battery charger
Windshield washer kit
Wash down w/ hose receptical
Bow live well pump kit
Stern live well pump kit
LED interior lights
LED Flood light
24" LED Light Bar
Additional 12 Volt plug
Electric trim tabs
Arm Rests (per set)
Suspension seats on swivels
Heated seats (each)
Tilt Steering
Bench seat locking drawers (ea)
Swivel chairs on rear bench seats
Bed rails

#### Table w/ Mount

Porta Potti
Side rod holders
3 step folding ladder

#### Paint

Team logo color scheme
Painted bow
Painted full transom
Paint gunnels
Premium Paint (see color chart)
Premium Paint w/ Hard Top
Hullside graphic package
Sharkhide hull protectant
Shrink wrap
Shrink wrap w/ hard top
2/3 Side paint
Full side paint

#### Hull Fab. Options

Net holder
Top pole holders (4)
Hard top side pole holders (4)
3/4 platform with kicker bracket
Full platform with kicker bracket
Wakeboard tower
Side gunwale lockers

#### Starboard transom door

Port hull side door
Raised self bailing deck
Weld on transom kicker bracket
Transom corner steering helm
Polished bow & stern rails
Polished Wake Tower

#### EZ LoaderTrailer

Powder Coated Trailer
Swing tongue
Aluminum wheels (each)
Electric brakes
Gateway Trailer upgrade
Extend length 1'

#### Kickers

Suzuki DF9.9THL
Yamaha T9.9LPHA
Honda BF10D3LHT
Kicker control at helm
Motor Tie Bar
Kicker Installation
Mercury 9.9 ELHPT BF Pro

## SPECIFICATIONS



Images shown may include optional features



Length	23' / 7m
L.O.A.	25' / 7.6m
Beam	108" / 2.74m
Height of Sides	40" / 101.6cm
Bottom Width	84" / 213.4cm
Approx. Dry Weight	3500 lbs. / 1588kg
Deadrise	Progressive 18°
Fuel Capacity	80 USG / 302L
Max. HP	400 HP
Transom Height	40" / 101.6m
Motor Length XL	25" / "XL"
<b>Aluminum Thickness / Alloy</b>	
Side	0.160", 4.06mm / 5052
Bottom	0.250", 6.35mm / 5086
Transom	0.250", 6.35mm / 5052

### Base engine

225 H.P. Extra Long shaft

Side mount controls

Tachometer

Does not include prop

Optional power 225 - 350 H.P.

Designed for rugged coastal water excursions, the Pilot caters to the adventurer in you without sacrificing style or comfort. Whether you're enjoying a weekend away with the family or rigging in for serious offshore fishing, the Pilot delivers on design quality and function.

# AVAILABLE OPTIONS



Optional Transom Door



Floor Fish Locker with Macerator Pump



Standard 9x12 Electric Trim Tabs



Spacious Fully Enclosed Cabin

### Standard Single Stage Colors



### Custom Metallic Base/Clear Colors



Images shown may include optional features

<b>Motor Options</b>				Heated seats (each)
Yamaha	Suzuki	Mercury	Honda	Anchor windlass
<b>Kickers:</b>				Solar Panel Charging Package w/ 145 watt, 8.3 amp solar panel w/ display & monitor
Suzuki 9.9 DF9.9THL				AC/DC Fridge
Mercury 9.9 ELHPT				Wallas Diesel heater/defroster
BF Pro Kicker				Wallas 85DU diesel stove / heater
Honda BF10D3LHT				Origo 2 burner alcohol stove
Yamaha T9.9 LPHA				Shore power package
Kicker tie bar				Bench seat locking drawers (ea)
Kicker control at helm				Tackle trays for side bench seat (ea)
Aux. station binnacle				Porta Potti
kicker control				3 Step folding ladder
<b>Pre-rig options</b>				Side gunwale lockers
Mechanical Engines		1 Engine -- 1 Station		Bed rails
1 Engine -- 2 Stations		2 Engine -- 1 Station		Welded Aluminum Radar Arch
2 Engine -- 2 Stations		1 Engine -- 1 Station		Macerator w/ pump-out / Toilet
1 Engine -- 2 Stations		2 Engine -- 1 Station		*Note: Heaters include built in 9.5 Gal tank with deck fill*
2 Engine -- 2 Stations		Power Steering		
Digital Throttle and				
Shift Engines		<b>Paint</b>		
<b>Upholstery / Canvas</b>				Painted full transom
Stern cover		Stern cover w/ window		Paint gunnels
Camper cover		Snap in carpet		Premium Paint w/ Hard Top
Privacy curtain				Hullside graphic package
<b>Cabin Options</b>				2/3 Side Paint
Welded standup head enclosure w/ flush toilet & enclosed holding tank				Full Side Paint
Galley w/ sink & drawers				Sharkhide hull protectant
Forward facing dinette interior				Shrink wrap w/ hard top
<b>Color Scheme</b>				<b>Hull Fab. Options</b>
Sun Fire Red		Black		Twin engine application
Burgundy		White		HT side rod holders (each)
Stellar Blue		Green		Net holder
<b>Interior Color</b>				Starboard transom door
Dark Interior		Light Interior		Port hull side door
Color matched interior				Aluminum diamond tread decking
<b>Top Color</b>				Trolling motor kit incl.: kicker bracket, quick fuel connect w/ fuel shut off valve
Light Gray		Black		Auxiliary steering station: (note does not include motor controls)
Dark Gray		Tan		Bow Thruster
<b>Additional Options</b>				Welded bow coaming
Garmin GPS / fish finder combo				Cabin roof ladder
Stereo w/ 4 spkrs & remote				Extend Length (per foot)
2 Bank automatic battery charger				110 gallon tank / 23' & 24'
Windshield washer kit				150 gallon tank / 25' & 26'
Wash down w/ hose receptacle				<b>EZ Loader Trailer</b>
V-berth windows				Aluminum wheels (each)
24" LED Light Bar				Electric brakes
LED Flood light				Electric / hydraulic Hydro-Star
Additional 12 volt plugs				
Diamond Sea Glaze / Sliding cabin door				

# 180 ECO JET

## SPECIFICATIONS



Images shown may include optional features

Length	18' / 5.5m
Beam	86" / 2.2m
Height of Sides	31" / 78.8cm
Bottom Width	66" / 1.68m
Approx. Dry Weight	1700 lbs. / 770kg
Deadrise	8°
Fuel Capacity	34 USG / 128.7L
Transom Height	31" / 78.8cm
<b>Aluminum Thickness / Alloy</b>	
Side	0.125", 3.18mm / 5052
Bottom	0.250", 6.35mm / 5086
Transom	0.190", 4.82mm / 5052
<b>Power</b>	
4.3L 225HP Vortec V6MPI	
American Turbine SD 203 Axial Flow	
Pump Includes Stainless Impellor	



### PERFORMANCE & ADVENTURE READY

Easy to tow, easy to drive, and easy on the pocket book, the Eco Jet is simply amazing! Built with the same attention to detail as our larger boats, the 180 Eco Jet delivers outstanding performance, style, and fuel efficiency.

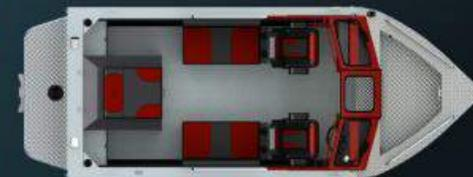

# SPECIFICATIONS

# BULL DOG PG 19

Length	18' / 5.49m
Beam	90" / 2.29m
Height of Sides	35" / 89cm
Bottom Width	72" / 1.83m
Approx. Dry Weight	2500 lbs. / 1134kg
Deadrise	8°
Fuel Capacity	48 USG / 180L
Transom Height	35" / 89cm

### Aluminum Thickness / Alloy

Side	0.125", 3.17mm / 5052
Bottom	0.375", 9.53mm / 5086
Transom	0.250", 6.35mm / 5052

### Power

4.3 liter , 225 H.P. Multi Port Injected V-6

Closed Cooling System

American Turbine 203 Axial Flow Pump

with stainless impeller



Images shown may include optional features

### THIS IS ONE TOUGH BOAT

The Bull Dog puts new meaning into jet boating, with a full UHMW bottom and our strongest hull ever, it will take you places you never dreamed possible. Hang on because you're in for one heck of a ride!



Optional Custom Graphics



Optional Bolster Seat



Full Side Paint

# NORTHERN EDITION ENVOY SPECIFICATIONS



Images shown may include optional features

Length	19' / 5.8m
Beam	84" / 2.13m
Height of Sides	31" / 78.7cm
Bottom Width	66" / 1.68m
Approx. Dry Weight	2400 lbs. / 1088.6kg
Deadrise	12°
Fuel Capacity	48 USG / 180L
Transom Height	31" / 78.7cm
<b>Aluminum Thickness / Alloy</b>	
Side	0.160", 4.06mm / 5052
Bottom	0.250", 6.35mm / 5086
Transom	0.190", 4.82mm / 5052
<b>Power</b>	
350cid Multi Port Fuel Injected GM Vortec	
Closed Cooling System 320HP	
American Turbine SD309 mixed flow jet pump with Split Duct Reverse Bucket	



## BUILT TO TAME THE OUTDOORS

The NE Envoy has been designed for the most extreme boater in the most demanding of conditions. The rough water package combined with the welded aluminum delta pad guard makes for one tough boat.

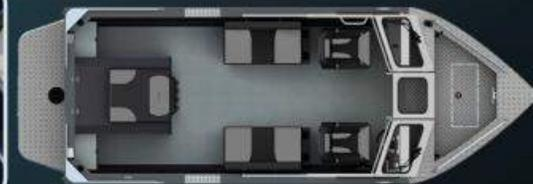

# SPECIFICATIONS

Length	20' / 6.1m
Beam	90" / 2.29m
Height of Sides	31" / 78.7cm
Bottom Width	72" / 1.83m
Approx. Dry Weight	2400 lbs. / 1089kg
Deadrise	12°
Fuel Capacity	48 USG / 180L
Transom Height	31" / 78.7cm
<b>Aluminum Thickness / Alloy</b>	
Side	0.125", 3.17mm / 5052
Bottom	0.250", 6.35mm / 5086
Transom	0.190", 4.82mm / 5052
<b>Power</b>	
350cid Multi Port Fuel Injected GM Vortec	
Closed Cooling System 320HP	
American Turbine SD309 mixed flow jet pump with Split Duct Reverse Bucket	

## INNOVATION BY DESIGN

The Luxor is a precision hand welded boat with Thunder Jet's exclusive Tri-Structure reverse chine hull technology, single piece formed sides and one piece hull. One of the most reliable and best engineered boats on the market.

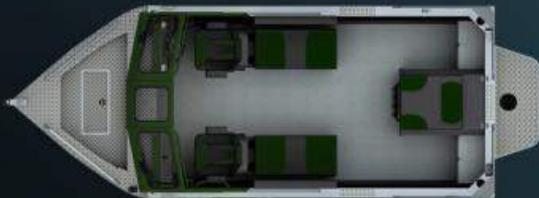

Images shown may include optional features

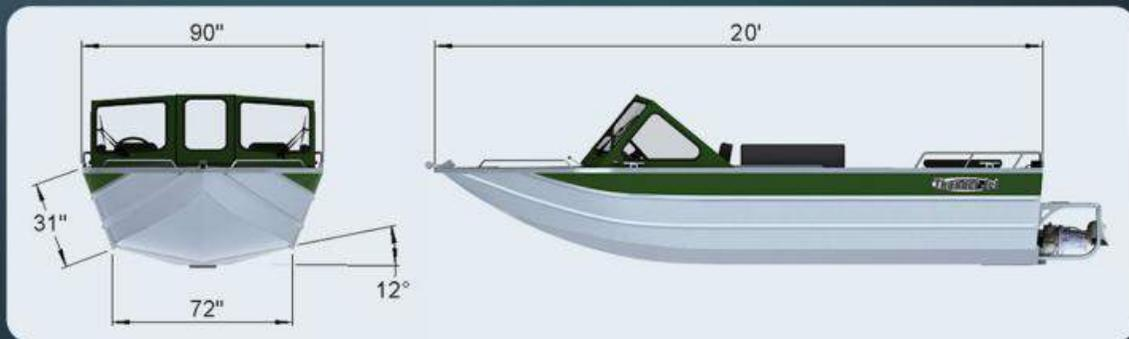

# ALEXIS

## SPECIFICATIONS

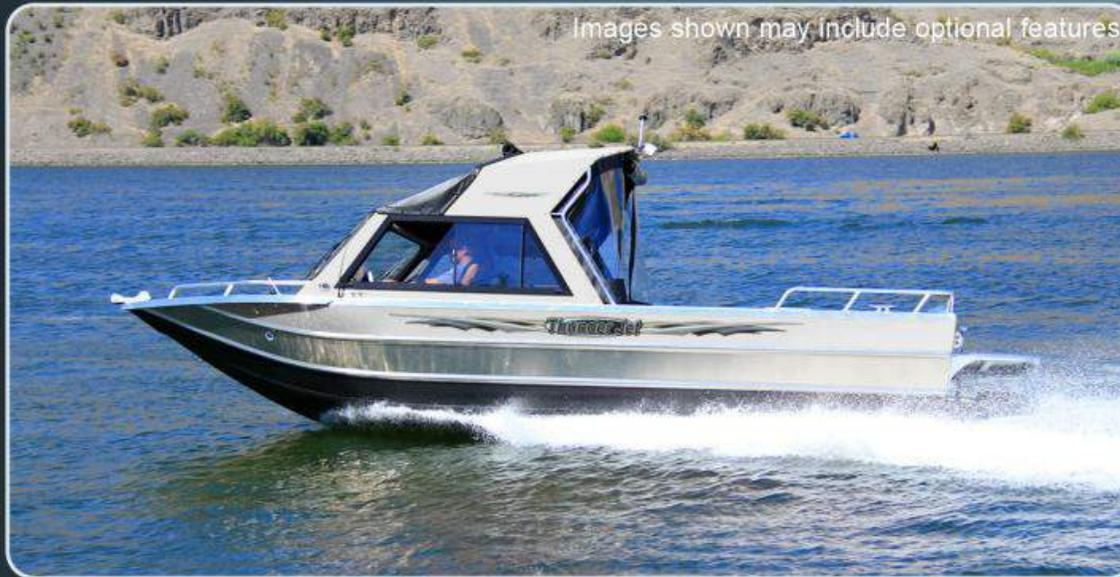

Images shown may include optional features

Length	21' / 6.4m
Beam	96" / 2.4m
Height of Sides	34" / 86.3cm
Bottom Width	72" / 182.8cm
Approx. Dry Weight	3200 lbs. / 1451kg
Deadrise	12°
Fuel Capacity	80 USG / 302.8L
Transom Height	34" / 86.3cm
<b>Aluminum Thickness / Alloy</b>	
Side	0.125", 3.17mm / 5052
Bottom	0.250", 6.35mm / 5086
Transom	0.190", 4.82mm / 5052
<b>Power</b>	
350cid Multi Port Fuel Injected GM Vortec	
Closed Cooling System 320HP	
American Turbine SD309 mixed flow jet pump with Split Duct Reverse Bucket	



### BIG ON STYLE, FORM & FUNCTION

The Alexis is Thunder Jets signature boat. It combines performance, value and style in a tough, durable package. This boat was designed to meet the harsh conditions on the Snake River and makes river boating a pleasure.

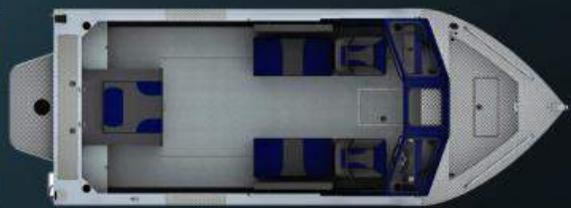

# SPECIFICATIONS

# ALEXIS CLASSIC PG 23

Length	21' / 6.4m
Beam	96" / 2.4m
Height of Sides	34" / 86.3cm
Bottom Width	72" / 7.83m
Approx. Dry Weight	3400 lbs. / 1542kg
Deadrise	12°
Fuel Capacity	80 USG / 302L
Transom Height	34" / 86.3cm

### Aluminum Thickness / Alloy

Side	0.125", 3.17mm / 5052
Bottom	0.250", 6.35mm / 5086
Transom	0.190", 4.82mm / 5052

### Power

350cid Multi Port Fuel Injected GM Vortec

Closed Cooling System 320HP

Hamilton Jet 212 Axial Flow Jet Pump with

JT Nozzle, Split Duct Reverse, Close

Coupling and Turbo Impellor

Images shown may include optional features



### TAKING STYLE AND FUNCTION TO THE NEXT LEVEL

The Alexis Classic is based on the ever popular Alexis but loaded with all the right options, including a larger fuel tank, 1/2 hard top, fish deck, and Hamilton pump for hauling all of your new found friends upriver.

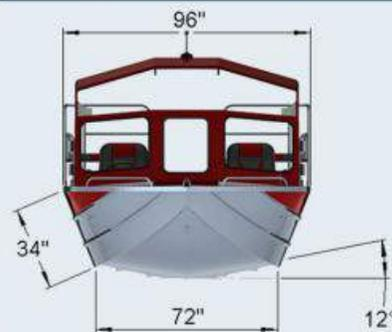

## SPECIFICATIONS



Length	22' / 6.7m
Beam	102" / 2.6m
Height of Sides	35" / 88.9cm
Bottom Width	78" / 2m
Approx. Dry Weight	4200 lbs. / 1905kg
Deadrise	14°
Fuel Capacity	80 USG / 302.8L
Transom Height	35" / 88.9cm
<b>Aluminum Thickness / Alloy</b>	
Side	0.125", 3.17mm / 5052
Bottom	0.250", 6.35mm / 5086
Transom	0.190", 4.82mm / 5052
<b>Power</b>	
350cid Multi Port Fuel Injected GM Vortec	
Closed Cooling System 320HP	
catalyzed exhaust w/ KLS mufflers and intake water strainer (sand trap)	
Hamilton Jet 212 axial flow jet pump with JT nozzle, split duct reverse, close coupling and turbo impellor	

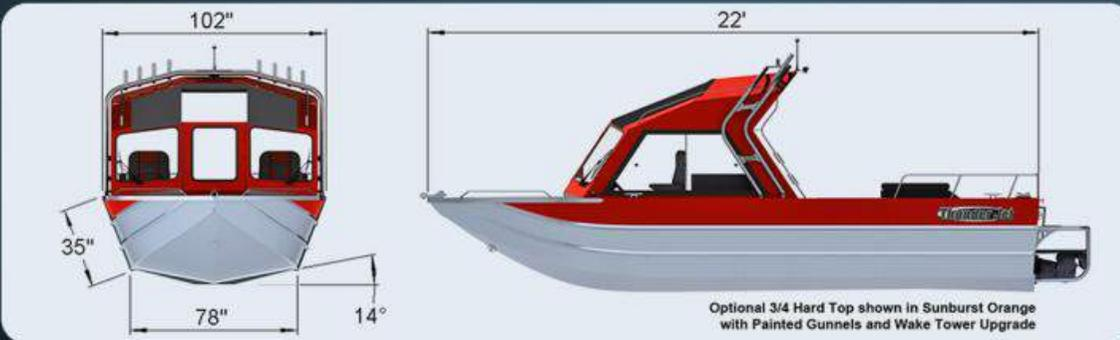

### WHEN ONLY THE BEST WILL DO

The Rio Classic is a 22 foot masterpiece with more standard features than any other model. This beauty is built to tame the roughest water and please even the most demanding boater.



# SPECIFICATIONS

# MAXIM CLASSIC PG 25

Length	23' / 7m
Beam	108" / 2.75m
Height of Sides	35" / 89cm
Bottom Width	84" / 2.13m
Approx. Dry Weight	4600 lbs. / 2087kg
Deadrise	12°
Fuel Capacity	110 USG / 416.4L
Transom Height	35" / 89cm

### Aluminum Thickness / Alloy

Side	0.125", 3.17mm / 5052
Bottom	0.250", 6.35mm / 5086
Transom	0.190", 4.82mm / 5052

### Power

6.2 liter 400 HP LS3

Closed Cooling System

Hamilton Jet 212 Axial Flow Jet Pump with

JT Nozzle, Split Duct Reverse, Close

Coupling and Turbo Impellor

Images shown may include optional features



### A BIG BODY BOAT

The Maxim Classic is a big river, big body boat for the serious jet boater. When you want to head way up river with all your friends and gear, this is the boat that will get you there and back safely with room to spare.

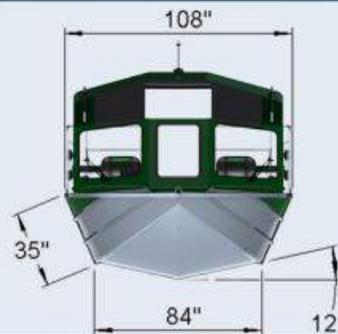



### Standard Single Stage Colors

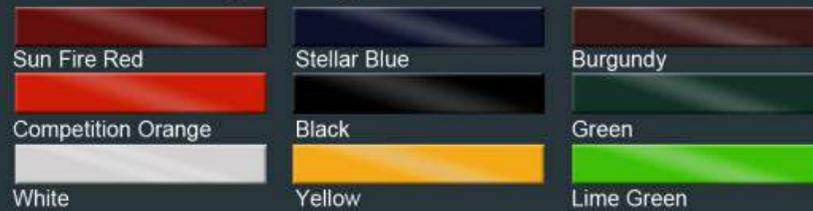

### Custom Metallic Base/Clear Colors



Put together your own customized Thunder Jet on our build a boat page at [www.thunderjet.com/build-a-boat](http://www.thunderjet.com/build-a-boat)

## AVAILABLE OPTIONS

#### Motor and Pump Options

- Vortec 350 PFI 320hp V8
- Vortec 6.0 L PFI 360hp
- 6.2L SC LSA 525hp
- 6.2L LS3 400hp
- Kodiak 2 Stg (6cyl only)
- Kodiak 3 Stg
- ATSD203
- ATSD309 w/ SDR
- AT312 w/ SDR
- AT HTR II Bucket
- AT SS Impellor
- AT Turbine Trim
- Hamilton 212
- Hamilton 213
- Hamilton 241
- Stomp Grate
- Vortec Mufflers
- KLS Mufflers
- Sound Dampening Pkg
- Throttle handle ext.
- Kickers and Options
- Suzuki DF 9.9THL
- Yamaha 9.9LPHB
- Honda BFP10D3LHT
- Kicker Control at Helm
- Kicker installation
- Merc. 9.9ELHPT BF Pro
- Hull Spec. Options
- .375 bottom (rear 48")
- 14 degree Deadrise
- 16 degree Deadrise
- 67 gallon tank upgrade(BullDog)

- 80 gallon tank upgrade(Alexis)
- Aluminum tread plate deck(BullDog)
- Rough water DLX
- Top
- 1/2 Hard top
- 3/4 Hard top
- Full Hard top
- Gull wing hatch
- Alaskan bulkhead
- Bow
- Bow winch w/ hatch & roller
- Bow live well kit
- Closed bow
- Bow locker w/ drain
- Anchor roller w/ jamb cleat
- Closed bow
- Detachable Bow ladder
- Stern
- Fish deck w/ 26" rails
- Fish deck w/ 32" rails
- Transom fish box
- Swim step
- Grab rail
- Swim ladder
- Transom live well
- Additional D/R mounts x2
- Upholstery / Canvas
- Sport interior package(BullDog)
- Rear Bench seat cushion(BullDog)
- Motor Deck cushion(Bull Dog)
- Padded window cover
- Step Cushions (set)
- Stern cover

- Snap in carpet
- Mooring cover
- Top down tow cover
- 4 Panel EZ access front canvas
- Drop Curtain
- Bolster seat upgrade ea.
- Stern cover w/ window
- Towing bra
- Color Scheme
- Sun Fire Red
- Black
- Burgundy
- White
- Stellar Blue
- Green
- Yellow
- Competition Orange
- New Lime green
- Interior Color
- Dark Interior
- Light Interior
- Color matched interior
- Top Color
- Light Gray
- Black
- Dark Gray
- Tan
- Additional Options
- Garmin GPS / Fish finder combo
- Suspension seats on swivels
- Heated seats (each)
- Locking glove box w/ radio shelf
- Stereo w/ 4 spkrs & remote

- Dual bilge pumps
- LED interior lights
- LED flood light
- 24" LED light bar
- Passenger wiper
- Wash down
- Bow live well pump kit
- Dual batteries
- 2 Bank automatic battery charger
- Heater/ defroster
- Sand trap
- Arm rests (per pair)
- Side bench seats
- Bench seat locking drawers (ea)
- Heated seats (each)
- Side rod holders
- Quick connect kicker fuel supply
- 6" Stern rails with downrigger
- mounting pads
- 3 step folding ladder
- Tilt helm
- Electric Trim tabs
- Bed rails
- Additional 12v plug
- Real teak deck (FD only)
- Paint
- Premium Paint (see color chart)
- 1/3 Hull side paint
- 2/3 Hull side paint
- Full side paint
- Painted bow
- Painted full transom
- Painted gunnels

- Custom Base/Clear Paint
- Sharkhide hull protectant
- Shrink wrap
- Custom Graphics package
- Polished bow and stern rails
- Team logo color scheme
- Hull Fab. Options
- Center console
- Cable Stick Steering
- Turn buckle trim tabs
- Net holder
- 3/4 platform
- Full platform
- .250 Delta pad guard
- Bullet proof bottom (V-6 only)
- Full UHMW bottom (V-6 only)
- Platform kicker bracket (loose)
- HT side mount rod holders (4)
- Wakeboard tower
- Welded pump guard
- Weld on transom kicker bracket
- Locking Glove Box w/ radio shelf
- Gateway Trailer
- Chine load guides
- Surge drum brakes
- Swing tongue
- Surge disc brakes
- Brake flush kit
- Upgrade to 3980 lb. cap
- Single axle trailer
- Spare Tire w/ mount
- Aluminum wheels (ea)
- Electric brakes
- Powder coated trailer

**!** Certain options may not be available to certain models

# Thunder Jet

POWERED BY YAMAHA



**Thunder Jet**

[www.thunderjet.com](http://www.thunderjet.com)

Your Authorized Dealer: