

Hybrid Camping Trailers

VIKING

SINCE 1972

Camping Made Easy





Setting the bar for Features, Function, Quality and Amenities is the Viking Camping Trailers. With sizes and models to fit the needs of all Camping Trailer enthusiasts, Viking is the clear choice for Today's discriminating Camper.



Features You Can't Live Without



Patent No. 7,204,538

Sliding Storage Trunk (SST)



New E-Z One-Hand Swing Level Galley (Legends and V1)



Optional Jensen AM/FM/Bluetooth Stereo with App Control and Int./Ext. Speakers (Std. on Legends, V-Trec and Hardsides)



Exterior Utility Shelf

◀ **One-Piece Entry Door**
The Clipper's one piece entry door features an extra large privacy panel that allows for finite adjustment for air and sunlight. (N/A 1706LS).



E-Z Swing Stepper Door



Optional Dometic® 3-Way Refrigerator



Dual Drive Dual Purpose Winch by Canimex



Scissor Style Stabilizer Jack



Optional Modular Cassette Potti with Electric Flush

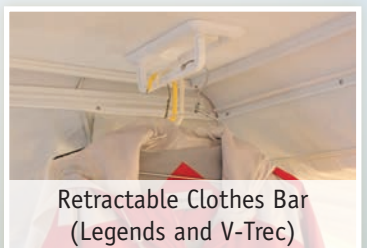

Retractable Clothes Bar (Legends and V-Trec)

THE VIKING

Difference.

Construction & Features Competitors Can't Match

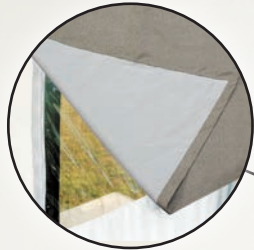

Lined drapes for improved privacy



Standard heated mattress
(Opt. on 1906 & 1906ST)
(N/A on LS Series)



"Glide-N-Lock" bed system is the only cable-supported bed system in the industry. Simply pull out the beds until they lock into place. No more awkward poles to contend with!

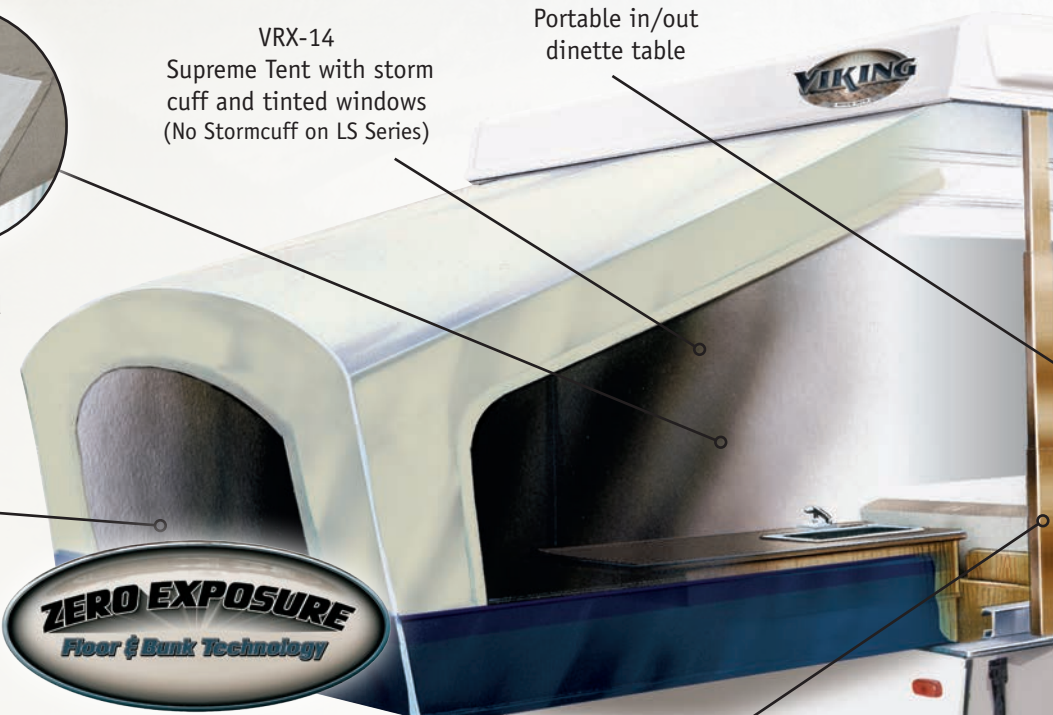

VRX-14 Supreme Tent with storm cuff and tinted windows (No Stormcuff on LS Series)

Portable in/out dinette table

ZERO EXPOSURE
Floor & Bunk Technology

Automotive undercoat paint is applied to all floors and Polyflex woven moisture barrier laminated to all Viking bunks vs. exposed wood used on competitive product. Another exclusive feature setting Viking apart from the everyday Camping trailer.

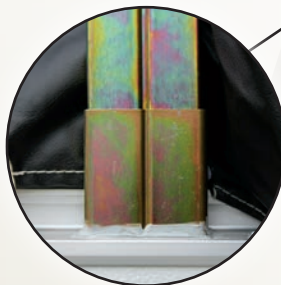

Goshen Stamping double-wide lifter post with limited lifetime warranty (N/A 1706 LS)

Largest heating capacity of any folding camper.

- Optional 20M BTU Suburban® Furnace with forced air, electronic ignition and thermostat control.

Wide Trac Suspension

Better safety and stability on the road.

- Widest stance of any folding camper
- Improves towing safety and stability
- Stronger axle beams than most competitors
- Steel frame with powdercoat protection

Viking Wide Trac
Competitors

Dura Tuff Roof

A. One Piece Seamless Skin

B. Dura Tuff Wood Protective Layer

No one else includes the extra wood layer between the top skin and internal foam that provides stiffness and reduces the probability of damage due to hail, road debris, etc.

C. Foam Roof Structure

D. Steel Reinforced Wood Frame

The roof is framed with steel supports to accept A/C on all models without extra reinforcement.

- Roof vent is placed off to the side so the A/C can be center-mounted without having to remove the vent. This design allows you to have both the vent and A/C.



Fantastic Fan™ power roof vent is standard on all models (Except LS Models)



Low profile tongue jack

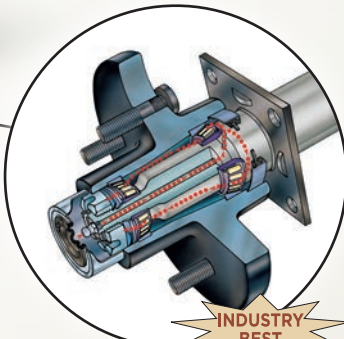

Ultralube axle bearing. Easier maintenance for improved safety

INDUSTRY BEST



Aluminum wheels (Standard on Legend, V-Trec and Hardside)



Roof Side Z-Rail Channels water away.

1. Roof's Outside Skin
2. Body's Outside Skin
3. Water tight Seal
4. Z-Rail channels water away from wood

- Z-Rails on roof perimeter and sidewalls keep wood above water level collection points.
- Others use U channel where wood and water can come in contact at the bottom of the channel.
- Channels are kept open to allow water to run out like a gutter.
- Others attempt to seal channels to keep water out; when the seal is compromised, water will collect and cannot escape.

1-1/4" Laminated Insulated Bunkend

(N/A 1706 LS)

- Double the industry standard thickness
- Solid wood, steel reinforced frame filled with 1" thick high density foam and laminated with wood panel on top and bottom
- Yields a more stable bedend vs. chipboard or spliced plywood used by other brands
- Insulation improves comfort and warmth

Viking Standard



Cold Outside Air

Competition



Cold Outside Air

LS Series

Limited Warranty

- Lift System - Lifetime
- Vinyl Tent - 5 years
- Roll Out System - 5 years
- Frame - 5 years
- Roof Assembly - 5 years
- AL-KO® Ultralube Spring Axle - 1 year
- Refrigerator - 3 years
- Plumbing System - 10/25 years
- Electronic Converter - 2 years
- Roof Exterior - 2 years

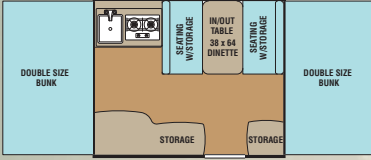

1706 LS

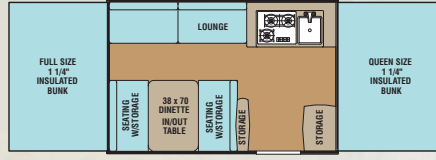

2107 LS

Epic Series

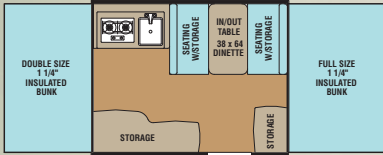

1906

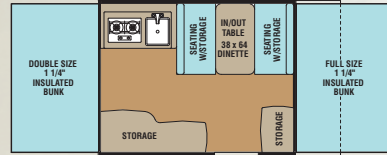

1906 ST

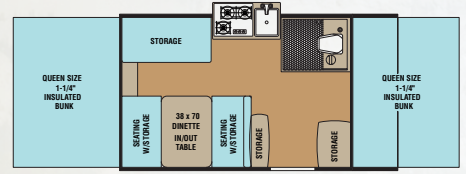

2105 ST

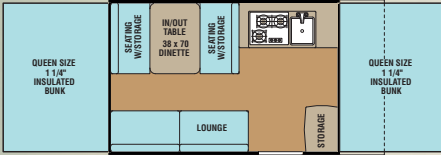

2108 ST

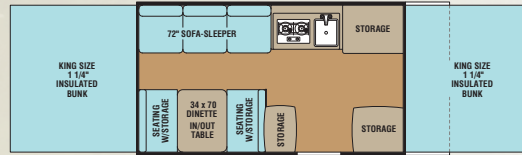

2405 ST

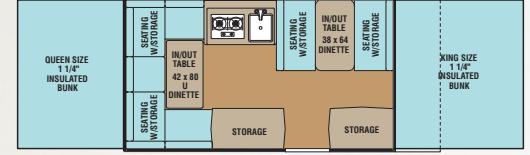

2308 ST

Legend Series

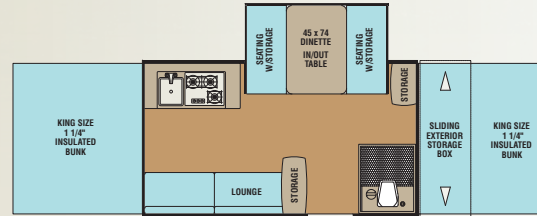

2485 SST

Legend Hardside

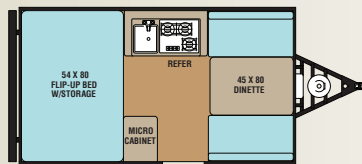

V12RB

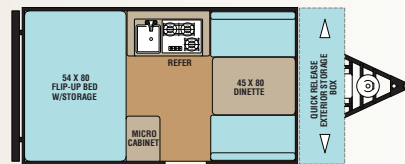

V12RBST

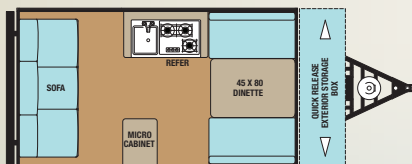

V12RSST

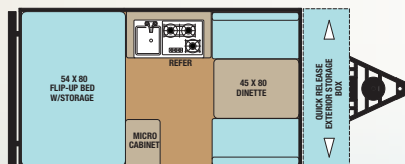

V12RBST HW

Standard Features

|LS|E|L|H|V|

|LS|E|L|H|V|

|LS|E|L|H|V|

CHASSIS	LS	E	L	H	V
Tubular Steel Frame					
Dual Drive Winch by Canimex					
Heavy Duty Dolly Jack with Wheel					
Wide Trac UltraLube Spring Suspension					
Wide Trac Torsion Axle					
Electric Brakes					
Radial Tires					
Aluminum Rims					
Scissor Jacks with Pads (4)					
Goshen Lift System with Double Arms (Single Arm on 1706LS)					
EXTERIOR					
“Zero Exposure” Bunk Technology					
Laminated Aluminum Skin Walls					
Laminated Hi-Gloss Fiberglass Walls					
Laminated Hi-Gloss Gray Fiberglass Walls (V-Trec Models)					
Diamond Plate Front Wall Protection					
E-Z Swing Stepper Door					
One Piece Screen Door (N/A 1706LS)					
4 Layer Laminated Seamless Fiberglass Roof Prebraced for A/C					
Exterior High Pressure LP Tank Hookup					

	LS	E	L	H	V
VRX Sectionalized Tent with Storm Cuff (Storm Cuff N/A LS Series)					
Laminated/Insulated Bed Platforms (N/A LS)					
Glide-n-Lock Cable Supported Bed System					
Exterior Utility Shelf					
Above Floor 16 Gallon Fresh Water Tank (1906, 1906ST, and LS Only)					
23 Gallon Below Floor Fresh Water Tank					
27 Gallon Below Floor Fresh Water Tank					
25 AMP Converter with Battery Charger (12 AMP on LS)					
120 Volt GFI Exterior Recept					
Amber Patio Light					
“SST” Super Sliding Storage Compartment 2485SST (Optional on V1)					
Removable Exterior Storage Box (12RBST, 12RSST, 12RBST HW)					
Exterior Storage Access Door(s) (N/A LS, 1906, 2107, V1)					
Create a Breeze Power Roof Vent					
Tinted Safety Glass Windows					
INTERIOR					
100% Adhesion Residential Grade Linoleum					
Walnut Cabinetry					
Mortise and Tenon Residential Cabinet Doors					
Residential Laminated Countertops					

	LS	E	L	H	V
Ultra Comfort 4" Heated Mattresses (N/A LS) (Optional 1906, 1906ST)					
High Density Serta Mattresses					
Ultra Comfot 4" High Density Cushions					
Lined Privacy Drapes (Vented on Bed Ends N/A LS)					
E-Z Swing Galley with Drawer					
Microwave					
Deep Bowl Acrylic Sink					
3 Burner Range (2 Burner on 1706LS, 2107LS, 1906, and 1906ST)					
12 Volt On Demand Water Pump					
Built in Shower (2105ST, 2485SST, and V3)					
Thetford Cassette Potti (2105ST, 2485SST, and V3)					
DSI 6 Gallon Water Heater (2105ST, 2485SST, 12RB, 12RBST, 12RSST, 12RBST HW, V1 and V3)					
20,000 BTU Furnace					
Dometic Cool Cat Heat Pump					
Skylights with Night Shades					
Indoor/Outdoor Dinette Table					
12 Volt LED Interior Lights					
120 Volt Interior Outlets					
Retractable Clothes Bar					
Powdercoated Interior Tent Support Poles					

Popular Options

|LS|E|L|H|V|

|LS|E|L|H|V|

|LS|E|L|H|V|

Essentials Package	LS	E	L	H	V
✓ 3-Way Dometic® Refrigerator 1.9 Cu. Ft. (2.5 Cu. Ft. on Legend and V3)					
✓ 20,000 BTU Furnace					
✓ A & E Awning					
✓ Spare Tire, Carrier and Cover					
✓ 72" High Pressure LP Accessory Hose (N/A LS)					
Thetford Modular Cassette Potti with Electric Flush (2108ST, 2405ST, and V1)					
DSI Hot Water System W/ Hot/Cold Exterior Shower (1906ST, 2107, 2108ST, 2405ST and 2308ST ONLY)					

	LS	E	L	H	V
Screenroom with Privacy Flaps					
Single LP Bottle Cover (N/A V1 & V3)					
Double LP Bottles Rings and Cover (Std. on 12RB, 12RBST, V1, and V3)					
Hanging Storage Cabinet					
Bed End Fan Light (1 Standard on Legend and V Trec)					
Second Bed End Fan Light (N/A LS Models)					
Ultra Comfort 4" Heated Mattresses (1906, 1906ST Only)					
High Density Serta Mattresses					

	LS	E	L	H	V
AM/FM/Bluetooth W/Exterior Speakers (Std. on Legend Hardside and V-Trec)					
Coleman Outdoor Grill and Stand					
SST Super Sliding Storage Trunk (V1)					
Laminated High Gloss Tan Fiberglass Walls (Std. on 12RB, 12RBST, 12RSST and 12RBST HW)					
13.5M Air Conditioner					
40 Watt Portable Zamp Solar Panel					
80 Watt Portable Zamp Solar Panel					
Bathroom Package (2405ST Only)					
Awning and Skirt Package					

LS = LS Series E = Epic L = Legend V = V-Trec

Specifications

1706 LS 2107 LS 1906 1906 ST 2105 ST 2108 ST 2405 ST 2308 ST 2485 SST V12RB V12RBST V12RSST V12RBSTHW V1 V3

	LS Models		Epic Series				Legend		Legend Hardside				V-Trec		
Interior Box Size:	8'	10'	8.5'	8.5'	10'	10'	12'	12'	12'	12'	12'	12'	12'	10'	12'
Travel Length:	12' 2"	14' 2"	12' 8"	14' 10"	16' 4"	16' 4"	18' 3"	18' 3"	18' 5"	16' 7"	20' 2"	20' 2"	20' 2"	16' 9"	21' 4"
Travel Width:	85"	85"	85"	85"	85"	85"	85"	85"	85"	88"	88"	88"	88"	85"	85"
Travel Height:	54"	58"	56"	56"	58"	58"	58"	58"	55"	59"	59"	59"	59"	65"	65"
Interior Open Length:	16' 11"	20' 5"	17' 11"	17' 11"	20' 9"	20' 9"	24' 5"	23' 5"	24' 5"	12'	12'	12'	12'	20' 5"	24' 5"
Interior Open Height:	6' 10"	6' 10"	6' 10"	6' 10"	6' 10"	6' 10"	6' 10"	6' 10"	6' 10"	95"	95"	95"	95"	6' 10"	6' 10"
Sleeping Capacity:	6	7	6	6	6	7	8	8	6	4	4	4	4	6	6
Front Sleeping Area:	48" x 80"	58" x 80"	54" x 80"	54" x 80"	58" x 80"	58" x 80"	70" x 80"	70" x 80"	70" x 80"	N/A	N/A	N/A	N/A	58" x 80"	70" x 80"
Rear Sleeping Area:	48" x 80"	54" x 80"	48" x 80"	48" x 80"	58" x 80"	58" x 80"	70" x 80"	58" x 80"	70" x 80"	54" x 80"	54" x 80"	N/A	54" x 80"	58" x 80"	70" x 80"
Dinette Area:	38" x 64"	38" x 70"	38" x 64"	38" x 64"	38" x 70"	38" x 70"	38" x 70"	38" x 70"	38" x 64"	41" x 74"	45" x 80"	45" x 80"	45" x 80"	38" x 70"	41" x 74"
"U" Dinette	N/A	N/A	N/A	N/A	N/A	N/A	N/A	42" x 80"	N/A	N/A	N/A	N/A	N/A	N/A	N/A
Lounge Area:	N/A	80"	N/A	N/A	N/A	N/A	N/A	N/A	N/A	N/A	N/A	N/A	N/A	N/A	N/A
Sofa Bed:	N/A	N/A	N/A	N/A	N/A	34" x 76"	40" x 72"	N/A	N/A	N/A	N/A	40" x 72"	N/A	N/A	N/A
Radial Tire Size:	5.30X12	5.30X12	ST145R12	ST145R12	ST145R12	ST185/80R13	ST185/80R13	ST185/80R13	ST185/80R13	ST185/80R13	ST185/80R13	ST185/80R13	ST185/80R13	LT235/75R15	LT235/75R15
Tire Load Range:	5 Bolt C	5 Bolt C	5 Bolt C	5 Bolt C	5 Bolt C	5 Bolt D	5 Bolt D	5 Bolt D	5 Bolt D	5 Bolt D	5 Bolt D	5 Bolt D	5 Bolt D	5 Bolt C	5 Bolt C
Hitch Weight (Lbs./Kg.):	120/55	210/95	116/53	184/83	214/96	187/85	243/109	191/87	282/128	222/101	320/145	321/146	337/153	252/114	420/191
Axle Weight (Lbs./Kg.):	1138/51	1576/715	1338/607	1381/627	1961/883	1667/756	2083/938	1859/843	2403/1090	1724/782	1845/837	1840/835	1893/859	1981/892	2700/1225
Dry Weight (Lbs./Kg.):	1305/591	1786/810	1503/682	1651/749	2175/980	1863/845	2326/1048	2154/977	2702/1226	1946/883	2165/982	2161/980	2230/1011	2233/1013	3065/1390
Cargo Capacity (Lbs./Kg.):	778/353	514/233	813/369	733/332	526/237	824/374	1120/505	1257/570	800/363	1662/754	1453/659	1546/701	1439/677	1519/689	1325/601
GVWR (Lbs./Kg.):	2098/952	2300/1043	2096/951	2200/999	2718/1224	2702/1227	3463/1560	3464/1571	3502/1588	3642/1652	3635/1649	3741/1697	3757/1704	3994/1799	4380/1987
Coupler Size:	2"	2"	2"	2"	2"	2"	2"	2"	2"	2"	2"	2"	2"	2-5/16"	2-5/16"

*Weights shown are approximate. †Estimated Average based on standard build optional equipment. All weights shown are in Pounds/Kilograms.

V-Trec

Heavier Duty Than Other Folding Campers!



Specs | V1 V3

Interior Box Size	10'	12'
Travel Length	16'9"	21'4"
Travel Width	85"	85"
Travel Height	65"	65"
Interior Open Length	20'5"	24'5"
Interior Open Height	6'10"	6'10"
Sleeping Capacity	6	6
Front Sleeping Area	58 X 80	70 X 80
Rear Sleeping Area	58 X 80	70 X 80
Dinette Area	38 X 70	41 X 74
"U" Dinette	N/A	N/A
Lounge Area	N/A	N/A
Sofa Bed	N/A	N/A
Radial Tire Size	LT235/75R15	LT235/75R15
Tire Load Range	5 Bolt C	5 Bolt C
Hitch Weight # (approx.), (lbs./Kg)	252/114	420/191
Unloaded Vehicle Weight†	2233/1013	3065/1390
Cargo Carrying Capacity†	1519/689	1325/601
GVWR (lbs./Kg)	3994/1799	4380/1987
Coupler Ball Size	2-5/16"	2-5/16"

- 5" Tube Frame
- Reinforced Diamond Plate Front Deck
- 4000 Lb. Heavy Duty Leaf Spring Axle for Heavy Cargo Capacity

V-Trec Series

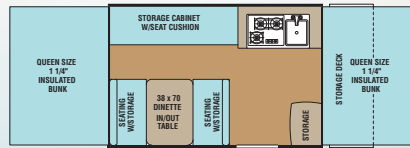

V1

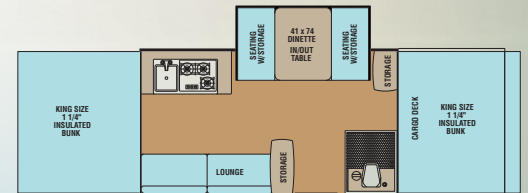

V3

† Estimated Average based on standard build optional equipment.
All weights shown are in Pounds/Kilograms.



Forest River, Inc. encourages our customers to purchase their Forest River products from a local dealership whenever possible for the following reasons:

- 1) Forest River, Inc. dealers are independently owned and operated businesses so priority service and scheduling is at their discretion and is often provided to customers that purchased their unit at that dealership.
- 2) Purchasing locally allows customers to establish meaningful relationships with a dealer, enhancing the RV experience through assistance with product questions, user tips or RV regulations for your state or country, and much more!
- 3) Canadian customers must meet requirements to bring an RV purchased out of the country to their home. These requirements may involve additional inspections and certifications, taxes and fees. Your local Canadian Dealer is a professional at meeting these requirements.
- 4) Scheduling timely warranty repairs and adjustments through a local dealership provides far greater flexibility and convenience to you, the customer!

It is the goal of Forest River, Inc. that all of our RV owners fully enjoy the RV experience and that customer satisfaction meets or exceeds their expectations!



PRE-DELIVERY INSPECTION FACILITY

20,000 square feet of quality assurance. The bare essentials for a premium product. This state-of-the-art facility gives immediate daily feedback to production for quality assurance in every unit built.



Learn More
Scan this barcode using a QR Reader on your smart phone to learn more about Forest River.



A Berkshire Hathaway company.



See your Viking Dealer for a complete list of parts and accessories.

www.vikingrv.com

269.467.6321

Viking Recreational Vehicles
A Forest River Company
580 West Burr Oak Street
P.O. Box 549
Centreville, MI 49032

All information contained in this brochure is believed to be accurate at the time of publication. However, during the model year, it may be necessary to make revisions and Viking reserves the right to make all such changes without notice, including changes in prices, colors, materials, equipment and specifications, as well as the addition of new models and the discontinuance of models shown in this brochure. Therefore, please consult with your Viking dealer and confirm the existence of any materials, design or specifications that are material to your purchase decision.