



SENECA™

2016

SEE IT ALL
#LETSJAYCO

2016 SENECA CLASS C MOTORHOMES



HANDS DOWN,
THE BEST RIDE.

2
YEAR
WARRANTY





#LETSJAYCO

When you travel with Jayco, fun is the only thing on the agenda. That's because we go the extra mile so you can live in the moment. From comfortable, amenity-packed floorplans to weather-shielding insulation and superior frame construction, you'll have everything you need to adventure every day and make yourself at home every night. Let's get away. Let's make it count. Let's Jayco—and make memories that last a lifetime.

GENERATIONS OF FAMILY FUN



SENECA

WE CARE ABOUT GETTING THERE AS MUCH AS BEING THERE

The power is in your hands with the 2016 Jayco Seneca. And with added features for smoother handling, the ride has never been so satisfying.

ENVIABLE PERFORMANCE



- **Freightliner® M2 106 chassis** delivers a tight 55-degree turning radius
- **Cummins® ISB 6.7L 340 HP diesel engine** features a 33,000-pound GCWR and a 28,000-pound GVWR; a 10,000-pound-rated hitch; and a gas-strut-assisted hood for easy engine access
- **Allison® 2500 MH automatic transmission** delivers the power, control and traction to handle anything the road throws at you
- **74-gallon fuel tank and 6-gallon DEF tank**
- **Michelin® 275/80R 22.5-inch tires**



Ride and Handling. Defined.

1. **Heavy-duty rear air suspension** improves sway control under heavy loads
2. **Front sway bar** reduces sideways tilt when cornering
3. **60-millimeter Bilstein® shocks** feature a unique monotube gas-pressure design that provides optimum ride quality and vehicle control
4. **Full air brakes*** offer peace of mind—even on the steepest inclines
5. **Air-ride seats*** offer comfort for the long haul

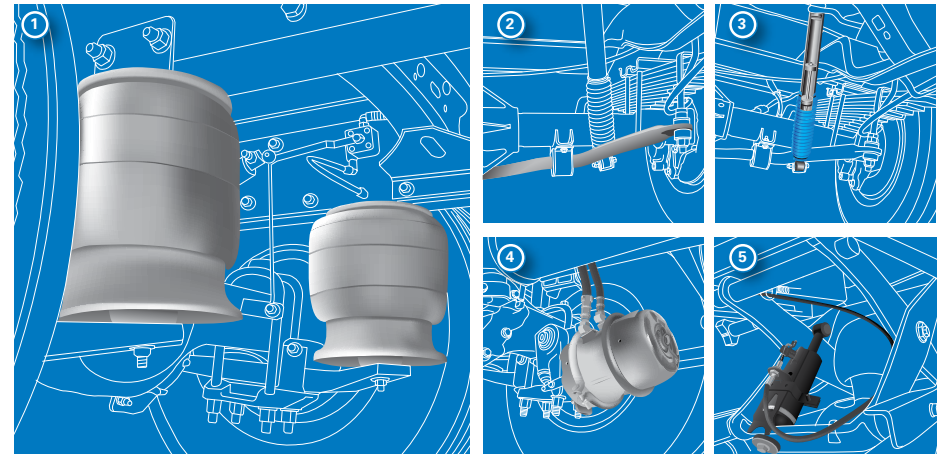

*2016 Freightliner chassis only

SHARE YOUR PHOTOS AND STORIES ON SOCIAL MEDIA WITH [#LETSJAYCO](https://www.instagram.com/letsjayco).



37TS INTERIOR WITH ROYAL GARNET DÉCOR



37HJ ENTERTAINMENT CENTER



37HJ BEDROOM



37TS KITCHEN



COCKPIT



EXTERIOR ENTERTAINMENT CENTER



THEFTORD® SANI-CON® TURBO MACERATOR SYSTEM

INTERIOR DÉCOR

GLORIOUS CREAM



ROYAL GARNET



STERLING



FLOORPLANS

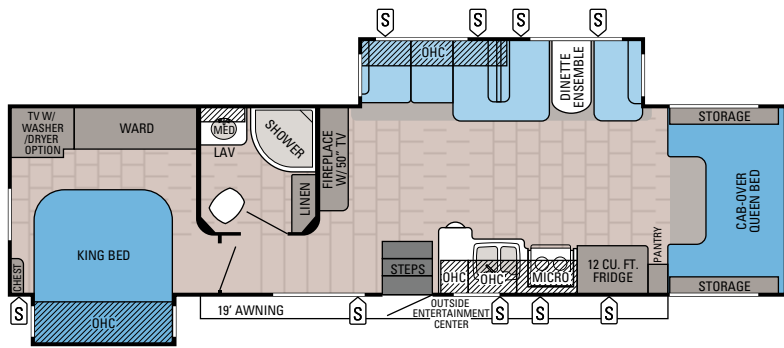

36FK – Sleeps: 5-7 **OPTION A**

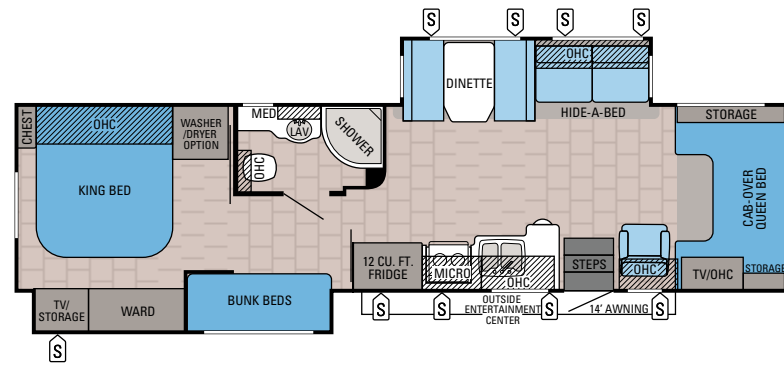

37FS – Sleeps: 7-9 **OPTION B**

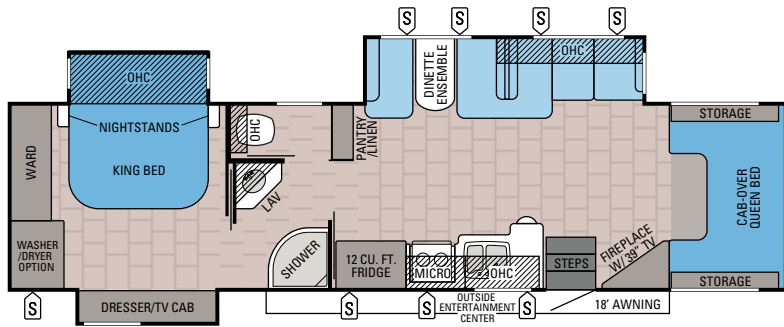

37HJ – Sleeps: 6-7 **OPTION A**

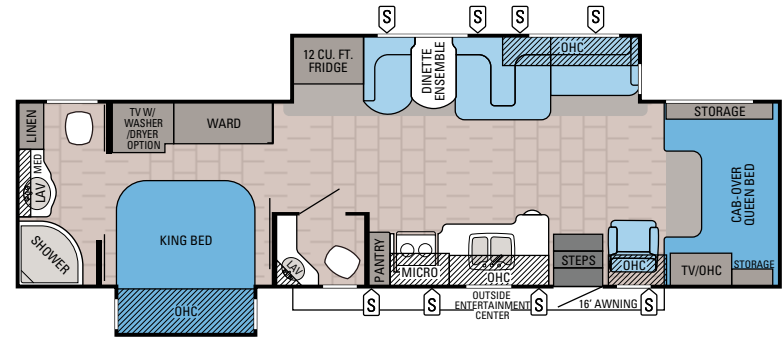

37RB – Sleeps: 5-7 **OPTIONS: B, C**

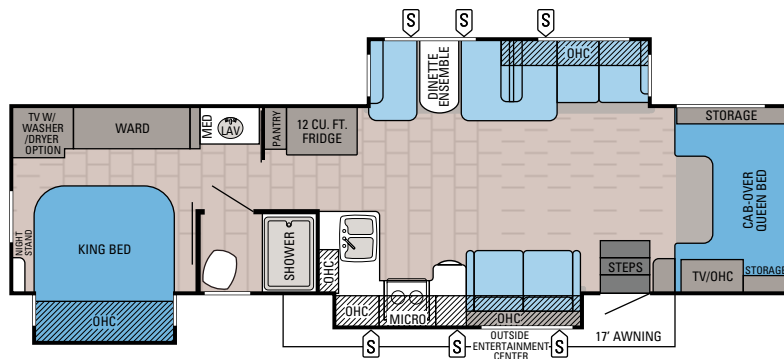

37TS – Sleeps: 5-7 **OPTIONS: A, B**

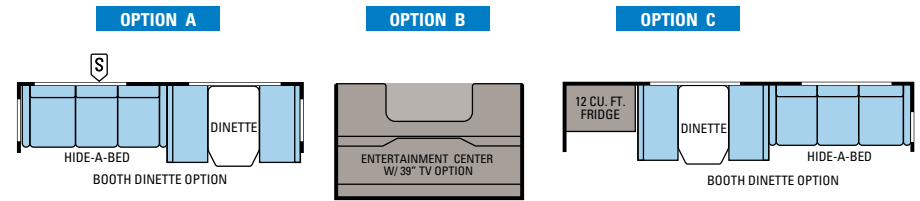

FULL-BODY PAINT OPTIONS



SUNSET



HOLLYWOOD



TOPAZ

STANDARDS AND OPTIONS

CUSTOMER VALUE PACKAGE

JRide Premium: Rear air suspension, front sway bar, Bilstein 60mm shock absorbers, full air brakes*, driver and passenger air-ride seats*

Touch-screen, in-dash sound system with built-in GPS and CD/DVD with MP3 input jack

Backup/side-view cameras with monitor

Frameless windows

15,000-BTU A/C (2) with heat pumps

1,800-watt pure sine inverter

Electric power cord reel with 50-amp service

12V electric awning with LED lights

12-cubic-foot refrigerator with icemaker

Convection microwave

Tankless water heater

STANDARD DRIVING EQUIPMENT

Freightliner Business Class M2 chassis—28,000-pound GVWR, 33,000-pound GCWR

SPECIFICATIONS

MODELS	DIMENSIONS				DRIVING FEAT.	TANKS (GALS.)			
	FLOORPLAN	EXTERIOR LENGTH	EXTERIOR WIDTH	EXT. HEIGHT (WITH A/C)	INTERIOR HEIGHT	WHEEL BASE	FRESH WATER CAPACITY	GREY WASTE WATER CAPACITY	BLACK WASTE WATER CAPACITY
36FK		38' 6"	102"	13' 1"	83"	269"	71.5	40	50
37FS		38' 10"	102"	13' 1"	83"	275"	71.5	40	50
37HJ		38' 10"	102"	13' 1"	83"	275"	71.5	40	33
37RB		38' 6"	102"	13' 1"	83"	271"	71.5	90.5	64
37TS		38' 10"	102"	13' 1"	83"	275"	71.5	40	50

Gross Vehicle Weight Rating (GVWR): The maximum permissible weight of the motorhome, including the Unloaded Vehicle Weight (UUV) plus passengers, personal items, all cargo, fluids, options and dealer-installed accessories. The GVWR is equal to or greater than the sum of the UUV and the Cargo Carrying Capacity.

Gross Combined Weight Rating (GCWR): The maximum allowable combined weight of the motorhome used as a tow vehicle and the attached towed vehicle.

It is important for your safety and enjoyment that you are aware of the weights and tow ratings of the RV you select. Consult a competent advisor for questions or advice. Whether you are new to RVing or a veteran, get a feel for the performance of your RV before heading out on the roadways. When you tow a vehicle with your RV, you must drive differently than when you drive a single vehicle. Practice hooking up, driving, backing up and braking in a safe environment or seek out professional instruction. Jayco affixes a weight label to each RV which lists weight information for that vehicle. Refer to that label to verify the vehicle will meet your requirements. See specifications chart above.

Cummins ISB 6.7L 340 HP diesel engine

Allison 2500 MH automatic transmission

10,000-pound hitch with 7-pin plug

74-gallon fuel tank

6-gallon DEF tank

Dual chassis batteries

Alcoa® aluminum rims

Michelin 275/80R 22.5-inch tires

Engine exhaust brake

Wood dash accents

Auxiliary start switch

Leather-wrapped steering wheel with cruise control

Deluxe heated, remote-control, side-view mirrors

Privacy curtains for cab area

STANDARD EXTERIOR EQUIPMENT

High-gloss, Gelcoat vacuum-bonded sidewalls, roof and floor

Deluxe full-body paint with Diamond Shield™

Sunset exterior paint

Bead-foam insulation (R-24 max roof, R-9 max floor and R-8 max walls)

One-piece fiberglass cap

Fiberglass entrance door with oversized frameless window

Keyless entry, touchpad locking system

Electric-powered entrance step

Slideout awning toppers

Dual-pane, tinted, safety-glass windows

Exterior entertainment center with AM/FM/CD/DVD player

and 39-inch TV and 2 speakers

Onan® 8,000-watt Quiet Diesel generator with auto-gen start

Slideout battery tray (4 batteries included)

56-pound propane tank

Black holding tank sprayer

Outside shower

Hydraulic automatic-leveling jacks

Winegard® in-motion satellite dish

Roof ladder

Thetford Sani-Con turbo macerator system

LP quick-connect hookup

STANDARD INTERIOR EQUIPMENT

Padded vinyl ceiling

Honey Cherry solid-hardwood, raised-panel doors

Ball-bearing drawer guides

Deluxe hidden cabinet hinges

LED-lit, solid-surface countertops with decorative backsplash

Water filtration system

2-burner induction cooktop

Dream Dinette mechanism, raises/lowers tabletop

2-point lap safety belts on all seating areas

Decorative tile flooring

Systems monitor panel

High-intensity recessed LED ceiling lights

12V electrical system with 120V, 80-amp power converter

34,000-BTU auto-ignition furnace with digital wall thermostat

Blu-Ray® with HDMI® connections to all televisions

Cable TV hookup with RG-6 coax

Residential medicine cabinet with mirror

Porcelain stool with foot pedal

One-piece fiberglass shower with glass shower door

Skylight in shower with light

King-sized bed with bedspread

Under-bed storage (select models)

24-inch LED HDTV in bedroom

Full cab-over bunk (750-pound rating)

Bunk beds (300-pound rating; 37FS)

OPTIONS

Hollywood exterior paint

Topaz exterior paint

Front entertainment center with LED TV (standard on 37HJ)

Canadian Shaw® satellite dish – DIRECTV®

Winegard TRAV'LER® satellite dish – DIRECTV

Booth dinette (36FK, 37HJ, 37RB, 37TS)

Washer/dryer combo (36FK, 37RB, 37TS)

Washer/dryer stackable (37FS, 37HJ)

*2016 Freightliner chassis only

LET'S JAYCO—AND ENJOY EVERY MILE.

We know that your family fun rides on our commitment to quality. So we go the extra mile to make products that last—and stand behind them longer than anyone in the business.



Generations of family fun.

THE JAYCO DIFFERENCE

When you go with Jayco, you get one of the industry's strongest frames and rock-solid construction.

1. **Seamless fiberglass front cap** for increased durability and ultimate weather protection
2. **750-pound overhead bunk capacity** offers nearly 250 pounds more than the industry average for greater safety and peace of mind
3. **Premium Sikkens Paint** gives you a superior, durable finish
4. **50-amp service and auto-generator start** offers an enhanced electrical system for the best in comfort and remote cooling when needed
5. **Seatbelts in every seating position** secure the most precious cargo

eco advantage™

Jayco's long-term commitment to generations of family fun

After four years of increased efforts to eliminate waste, conserve energy and increase recycling, we've come a long way in building RVs that are not only better for your family—but also better for the planet. **Learn more at Jayco.com/EcoAdvantage**

2
YEAR
WARRANTY

FREE

ROADSIDE
ASSISTANCE

Travel with confidence, with our industry-leading, bumper-to-bumper limited warranty and a year's access to Coach-Net™—the country's largest RV emergency road service.

For a copy of our 2-year limited warranty with full terms and conditions, please contact your local Jayco dealer.

Meet your Jayco Dealer

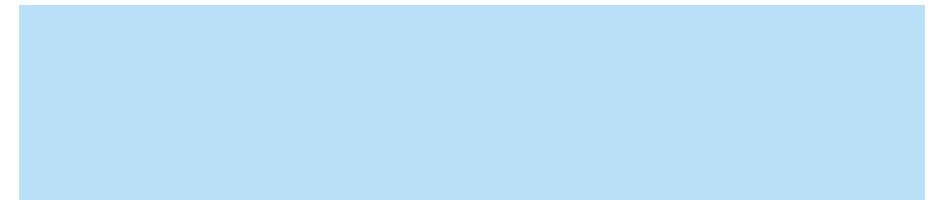

We work hard—so you can play hard. From finding the perfect Jayco for your family to providing flexible financing options and full-service support, we're here to help.

Follow Jayco



Jayco, Inc., P.O. Box 460, Middlebury, IN 46540, www.jayco.com  See dealer for further information and prices. All information in this brochure is the latest available at the time of publication approval. Jayco reserves the right to make changes and to discontinue models without notice or obligation. Photos in this brochure may show optional equipment and props for photography purposes. RVs built for sale in Canada may differ to conform to Canadian codes. ©2015 Jayco, Inc. 0815-50K Printed in U.S.A.