

Minnie Winnie

WINNEBAGO



Why Minnie Winnie?

- Five versatile floorplans offer flexible sleeping spaces
- Large rear trunk
- LED interior lights
- Optional heated electric drainage system
- Primera fabric on sofa and dinette
- Available front cap upgrade
- Stylish vinyl ceiling



On the Cover: 31K Tuscan Gold Standard Graphics with Available Front Cap

31K Stardust with Coffee-Glazed Vienna Maple Cabinetry

The #1 Choice for Value

There is no better value in Class C motorhomes than the popular Minnie Winnie®. That is because only the Minnie Winnie can offer Winnebago's legendary SuperStructure® construction at such a friendly price. LED lights and a stylish vinyl ceiling come standard and the popular Premium Package

(27Q, 31K, 31G) are available to enhance your experience at every turn. All five floorplans offer flexible sleeping spaces to accommodate your whole family along with a large rear trunk for all of your gear. Give it a try and you will see big value in the Winnebago Minnie Winnie.



Recognized Quality

The Recreation Vehicle Dealer Association annually rates RV manufacturers and awards the Quality Circle Award to manufacturers that provide exceptional products, service and support. Winnebago Industries is proud to be the only manufacturer that has received this award every year since its inception.



31K Stardust with Coffee-Glazed Vienna Maple Cabinetry

One reason families choose the Minnie Winnie is for its incredible sleeping flexibility. The furniture in each floorplan is specifically selected to maximize comfort and take advantage of the available space. For even more comfort and a selection of high-end amenities, add the Premium Package (27Q, 31K, 31G). It includes Primera covered cab seats, the Dream Dinette™ (27Q) table that glides into perfect position, a larger television, and much more. This package is one way to make the Minnie Winnie the motorhome you want it to be.



31K Sofa



31K Sofa as Bed



31K Overhead Bunk



31K U-Shaped Dinette



31K U-Shaped Dinette as Bed

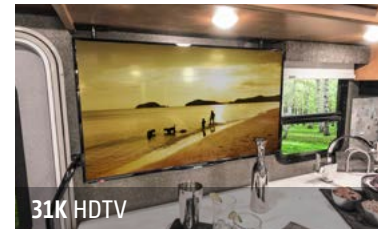

31K HDTV



MCD Solar/Blackout Roller Shades (Premium Package)



31K Galley with Premium Package

A microwave oven, refrigerator/freezer, and 3-burner range top come standard. Select the available microwave/convection oven (27Q, 31K, 31G) for a space-saving alternative that cooks and browns like a conventional oven in a fraction of the time. A 4-door refrigerator is available in the 31K and 31G to store additional food for your hungry guests.



31K Available 4-Door Refrigerator/Freezer



31K Available Microwave/Convection Oven



Full-Extension Drawer Slides



31K 3-Burner Range with Oven

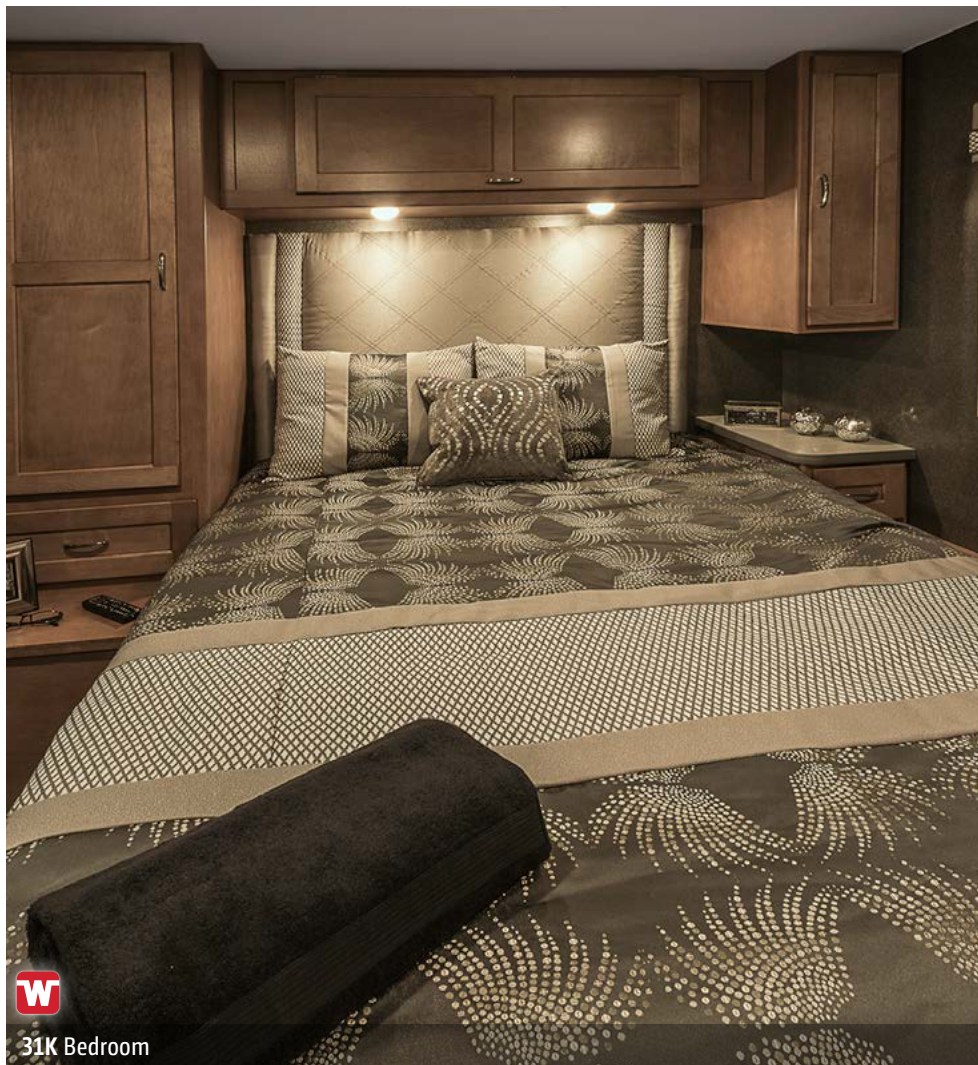

31K Bedroom

You'll find the private, walk-around queen bed (NA 22R, 25B) to be the perfect place to retreat after a long day. Add the available HDTV to enjoy your favorite shows in the evening. Bathroom amenities include a flexible showerhead, skylight, stainless steel sink, and an upgraded porcelain toilet with a sprayer in the Premium Package (27Q, 31K, 31G).



31K Available Bedroom HDTV



31K Wardrobe



31K Shirt Closet



31K Bathroom



31K Shower



Dash

Swivel cab seats (27Q, 31K) are one of our most popular options, giving you the ability to expand your living space when you aren't on the road. Listen to CDs or AM/FM radio on the perfectly-positioned dash stereo, or add the SiriusXM™ radio for additional listening options.



Radio with Available SiriusXM



31K Powered Patio Awning

One of the nicest features of the Minnie Winnie is the standard rear trunk. This large storage area lets you carry lawn chairs, golf clubs, and other large items—all with easy access. Those lawn chairs will come in handy under the standard patio awning.



Available Heated Mirrors with Cameras

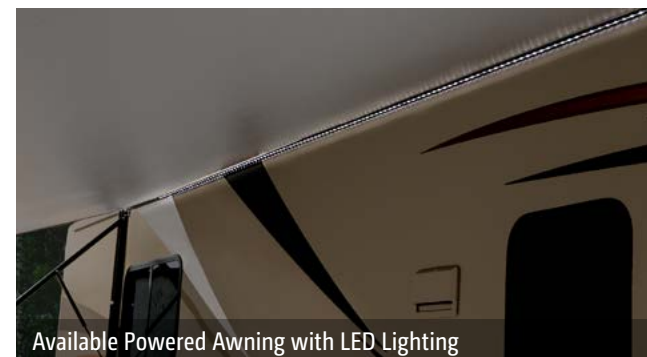

Available Powered Awning with LED Lighting



Exterior Storage



Exterior Rear Storage



Available Stainless Steel Wheel Liners



Entrance Door Steps

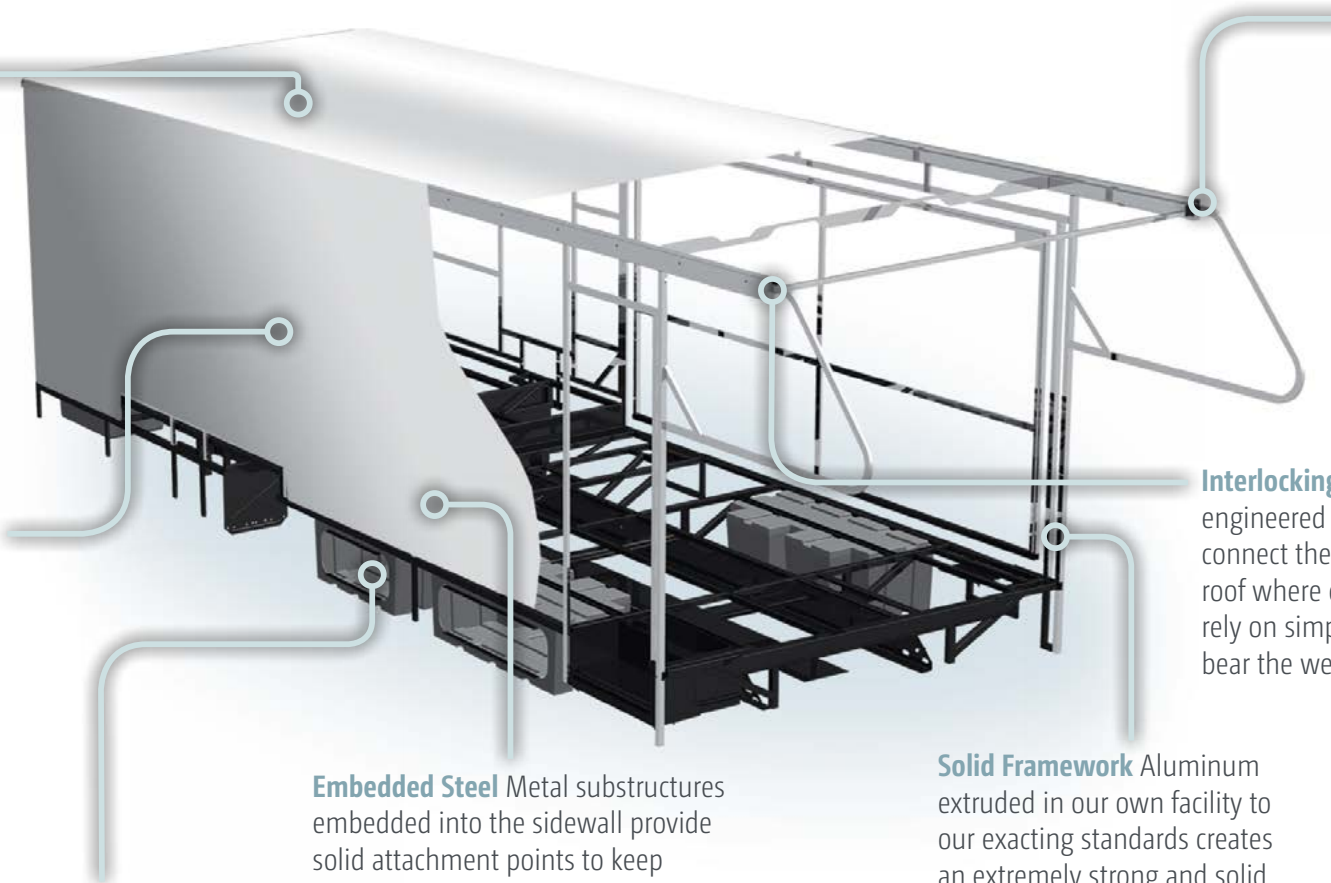

Fiberglass Roof

The one-piece fiberglass roof is backed by a 10-year limited parts-and-labor roof skin warranty.

Rubber Can't Cut It

Rubber roofs used by competitors can streak and degrade over time.

Thermo-Panel® Sidewalls

By layering fiberglass and high-density block foam insulation with welded aluminum support structures, we create some of the industry's strongest, most durable, and lightweight sidewalls.

E-Coating An electrodeposition coating helps protect critical steel components.

Embedded Steel Metal substructures embedded into the sidewall provide solid attachment points to keep cabinets and appliances mounted securely in place.

Laser-Cut Tubing

Precision laser cutters create precise joints in structural steel that are stronger and require less welding.



Interlocking Joints Specially engineered interlocking joints connect the floor, sidewalls, and roof where competitors often rely on simple screws to bear the weight.



Solid Framework Aluminum extruded in our own facility to our exacting standards creates an extremely strong and solid structural framework.

SUPER STRUCTURE®

BUILT TO LAST

Every coach—from our smallest Class C to our largest diesel-pusher model—is built to Winnebago's® legendary SuperStructure® construction standards. It's a process developed and refined over more than 50 years of building some of the strongest, most durable coaches in the industry.

TESTING

Before rolling out of our factories, every coach undergoes an extensive 113-point inspection. Each coach also passes a high-pressure water test that simulates rain at a rate of 50-inches per hour to check for leaks. During the design process, our computer simulations, physical testing center, and rigorous test track ensure each model is built to last.



DETAILS

At Winnebago, we treat the features you can't see with the same care as the ones you can. Look in the access panels of some of our competitors' coaches and you'll see loose insulation and wires haphazardly strewn about. Winnebago maintains a clean fit and finish throughout so your coach will last for the long haul.



BUILT IN-HOUSE

We extrude our own aluminum. We rotocast our own plastic components. In fact, we manufacture most of our own parts so they are designed to fit the space, rather than fitting the space to an awkward off-the-shelf component size.

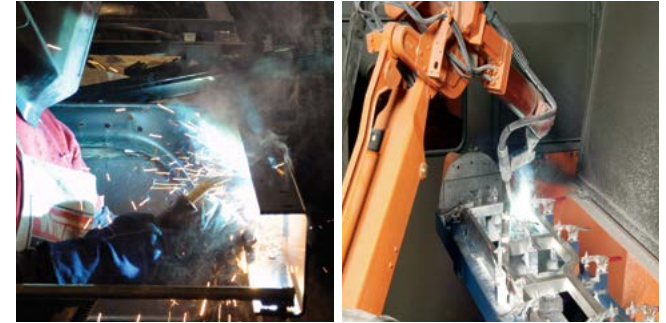

SUPER[®] STRUCTURE

BUILT TO LAST

Visit BetterBuiltRVs.com to gain real insight into what goes into a Winnebago motorhome.

TAKE A TOUR

We're proud of our processes, state-of-the-art facilities, and the people who make Winnebago number one. We invite you to visit our complex in Forest City, Iowa, for a firsthand look at the dedication and technology behind every motorhome we build.

Call (641) 585-6936 or (800) 643-4892 or visit us online at Winnebagolnd.com/company/visit for more information.



 [Click here to explore this floorplan's web page.](#)

22R

The U-shaped dinette makes the most of this floorplan, providing a comfortable place to eat or watch TV. It even converts into a third full-size sleeping space.

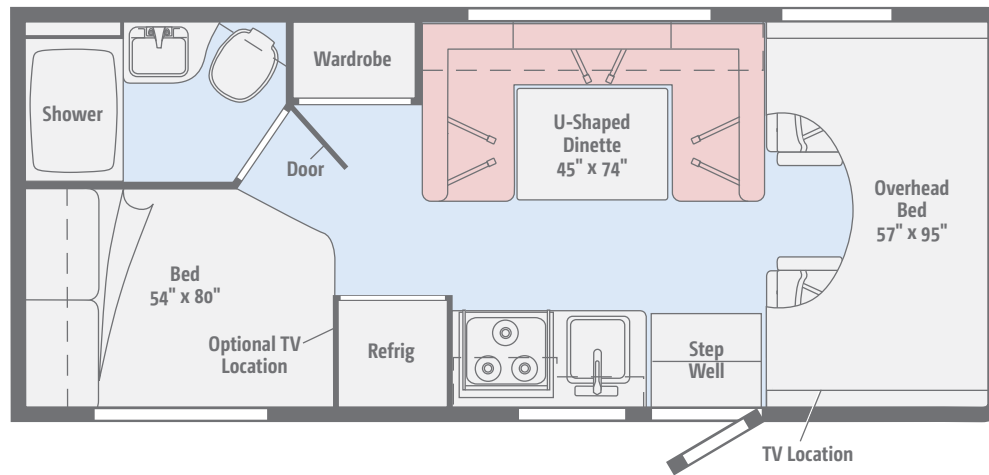

[Click here to explore this floorplan's web page.](#)

25B

A large rear trunk, corner bed, and your choice of a sofa/bed or dinette make this a great value for any traveling couple or family.

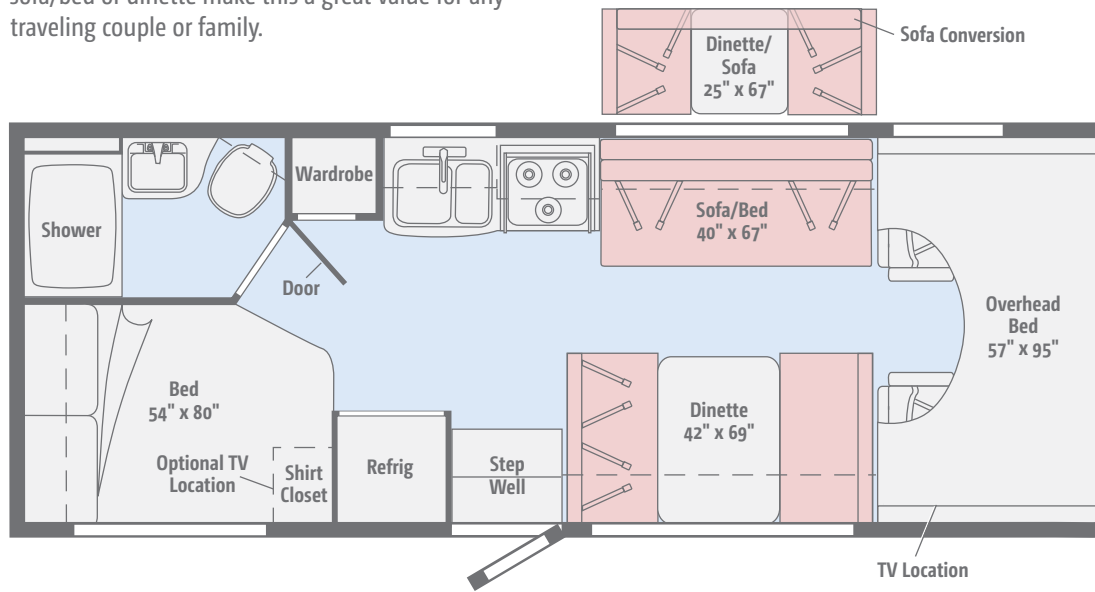

 [Click here to explore this floorplan's web page.](#)

27Q

A walk-around queen bed and a dinette slideout deliver family-friendly fun. Upgrade to swivel cab seats for an expanded living space.

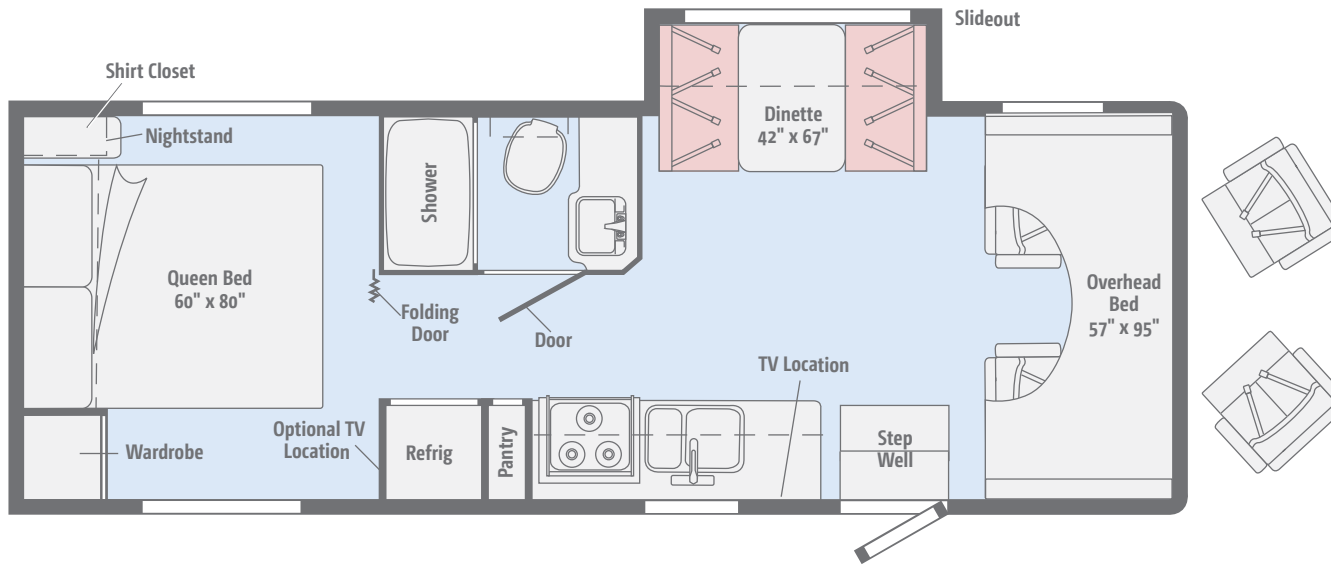

[Click here to explore this floorplan's web page.](#)

31K

A large lounge slideout holds both the U-shaped dinette and sofa/bed, while presenting plenty of workspace in the galley.

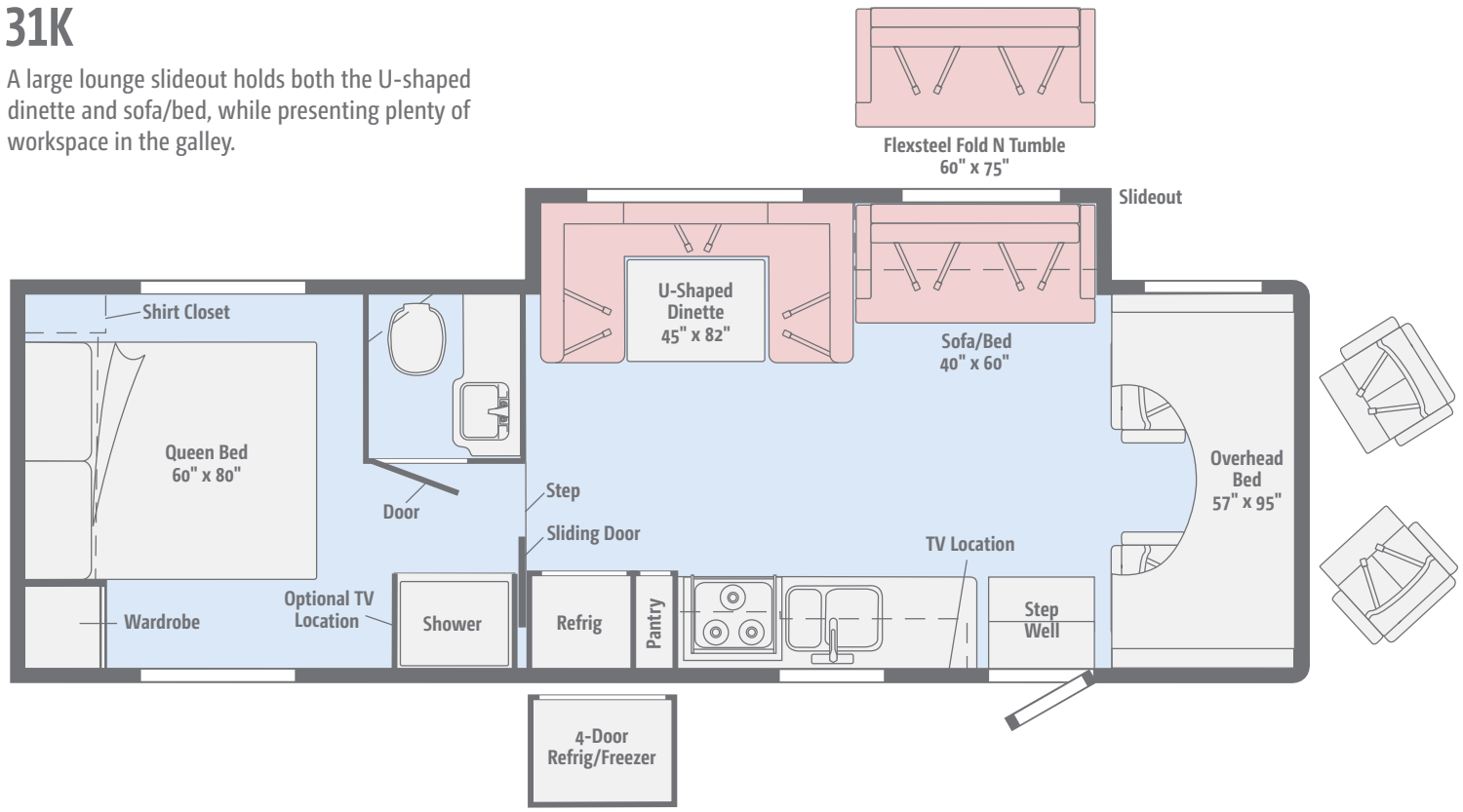

Primera Vinyl

 [Click here to explore this floorplan's web page.](#)

NEW
31G

A full-length slide opens a world of possibilities that includes bunk beds, a spacious angled galley, a booth dinette and an optional tailgate package.

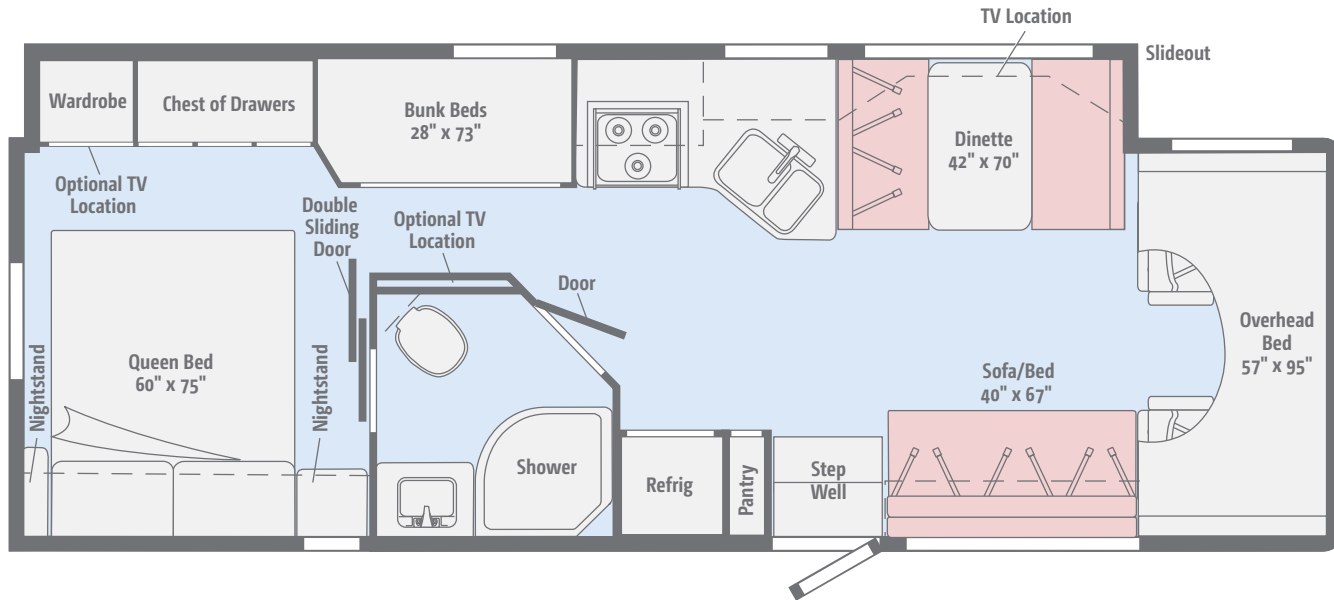

Legend



Primera



Feature Fabric



Bed Cover



Laminate Countertop



Corian Galley Countertop
(Premium Package Upgrade)



Vinyl Flooring



Coffee-Glazed
Vienna Maple



Coffee-Glazed
Honey Cherry



Driftwood

Winnebago® reserves the right to change décor materials and specifications without notice or obligation.

Infinity



Primera



Feature Fabric



Bed Cover



Laminate Countertop

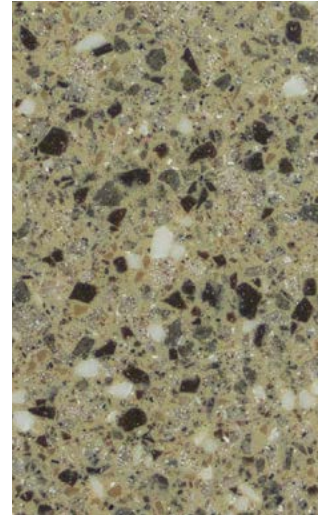

Corian Galley Countertop
(Premium Package Upgrade)



Vinyl Flooring



Coffee-Glazed
Vienna Maple



Coffee-Glazed
Honey Cherry



Driftwood

Winnebago® reserves the right to change décor materials and specifications without notice or obligation.

Rockslide



Primera



Feature Fabric



Bed Cover



Laminate Countertop



Corian Galley Countertop
(Premium Package Upgrade)



Vinyl Flooring



Coffee-Glazed
Vienna Maple



Coffee-Glazed
Honey Cherry



Driftwood

Winnebago® reserves the right to change décor materials and specifications without notice or obligation.

Stardust



Primera



Feature Fabric

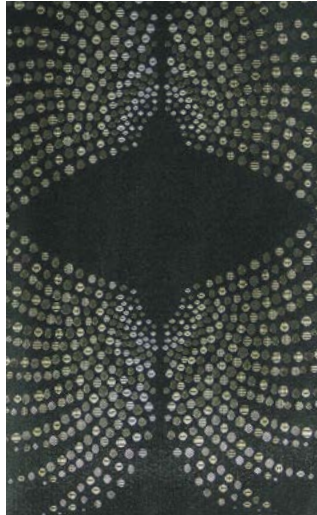

Bed Cover



Laminate Countertop



Corian Galley Countertop
(Premium Package Upgrade)



Vinyl Flooring



Coffee-Glazed
Vienna Maple



Coffee-Glazed
Honey Cherry



Driftwood

Winnebago® reserves the right to change décor materials and specifications without notice or obligation.

Choose from three stylish graphics selections with an optional front cap upgrade (NA 31H).



Polar Tuscan Gold
STANDARD GRAPHICS



Available Front Cap
(NA 31H)

Choose from three stylish graphics selections with an optional front cap upgrade (NA 31H).



Available Front Cap
(NA 31H)

Tuscan Gold
STANDARD GRAPHICS

Choose from three stylish graphics selections with an optional front cap upgrade (NA 31H).



Bronze Mist
DELUXE GRAPHICS



Available Front Cap
(NA 31H)

Weights & Measures	22R	25B	27Q	31K	31G
Length	23'10"	26'2"	28'6"	32'9"	32'9"
Exterior Height ¹	11'	11'	11'1"	11'1"	11'1"
Exterior Width ²	8'5.5"	8'5.5"	8'5.5"	8'5.5"	8'5.5"
Exterior Storage ³ (cu. ft.)	61.1	76	83	101	86.1
Awning Length	14'	17'	17'	20'	19'
Interior Height	6'10"	6'10"	6'10"	6'10"/6'5.5"***	6'10"/6'5.5"***
Interior Width	8'	8'	8'	8'	8'
Freshwater Tank Capacity ⁴ (gal.)	40	40	44	44	44
Water Heater Capacity (gal.)	6	6	6	6	6
Holding Tank Capacity - Black/Gray ⁴ (gal.)	21/24	23/27	30/35	30/30	37/57
LP Capacity ⁵ (gal.)	18	18	18	18	18
Fuel Capacity (gal.)	55	55	55	55	55
GCWR ⁶ (lbs.)	13,000 ^A	13,000 ^A /22,000 ^B	22,000 ^B	22,000 ^B	22,000 ^B
GVWR (lbs.)	11,500 ^A	11,500 ^A /14,500 ^B	14,500 ^B	14,500 ^B	14,500 ^B
GAWR - Front (lbs.)	4,600 ^A	4,600 ^A /5,000 ^B	5,000 ^B	5,000 ^B	5,000 ^B
GAWR - Rear (lbs.)	7,800 ^A	7,800 ^A /9,600 ^B	9,600 ^B	9,600 ^B	9,600 ^B
Wheelbase	158"	182"	190"	220"	220"
Seating Capacity	5	6	6	7	7

** Rear of Coach ^A Ford E350 Chassis ^B Ford E450 Chassis

Optional Package Upgrades

Convenience Package front bunk ladder, bunk privacy curtain, additional deep-cycle, Group 24 battery, glass shower door, 3-burner range w/oven, rear ladder, Radio/Rearview Monitor System, stainless steel wheel liners and valve extenders, black tank flushing system, TrueLevel™ monitoring system

Premium Package (27Q, 31K)

Requires Convenience Package, Corian® countertop and backsplash, galley w/stainless steel undermount sink and Corian sink cover, Primera cab seat covers, 40" HDTV upgrade (31K), headboard upgrade, Dream Dinette™ table mechanism (27Q), fold-over bedspread w/pillow fillers, power ventilator w/rain cover, electric lift, remote, intake and exhaust airflow, DSI gas/electric water heater, dash appliqué, MCD solar/blackout roller shades (MCD blackout roller shades in bedroom), porcelain toilet w/sprayer, stainless steel bathroom sink, single-control faucets, window treatment upgrade, sofa pillows (31K), frosted mirror refrigerator inserts, frosted mirror overhead door inserts

Exterior Tailgate Package (31G) 32" HDTV, stereo w/remote, AM/FM radio, DVD player w/remote, two exterior speakers, radio antenna, exterior wash station w/lighted pump switch, coiled water hose, quick-disconnect and sprayer head, refrigerator (2.6 cu. ft.), two shelves, LP QuickConnect, 110 V/AC receptacle, 24"x48" folding table

Chassis

Ford® E350 Chassis (22R, 25B) 255-hp 5.4L Triton® V8 engine, TorqShift™ 5-speed automatic transmission w/overdrive, 120-amp. alternator

Ford E450 Chassis (27Q, 31K, 31G) 305-hp 6.8L SEFI Triton V10 engine, TorqShift 6-speed automatic transmission w/overdrive, 120-amp. alternator

4-wheel ABS

Wheel covers

Rear auxiliary springs (31G)

OPTIONAL EQUIPMENT

Rear auxiliary springs (NA 22R, 25B)

Ford E450 Chassis (25B) 305-hp 6.8L SEFI Triton V10 engine, TorqShift 6-speed automatic transmission w/overdrive, 120-amp. alternator

Trailer Hitch⁶ 5,000-lb. drawbar/350-lb. maximum vertical tongue weight

Cab Conveniences

Radio w/AM/FM stereo, CD player

Cab seats armrests, fixed lumbar support, and multi-adjustable slide/recline

3-point seat belts

Airbags driver and passenger

12-volt powerpoint

Power steering w/tilt and cruise control

Power door locks

Sunvisors

Manual mirrors w/breakaway arms

Cab mat

Swivel cab seat pedestal (27Q) (driver and passenger)

OPTIONAL EQUIPMENT

Swivel cab seat pedestal (31K) (driver and passenger)

SiriusXM™ radio, receiver, iPod® input (requires Convenience Package)

Seat booster cushions (27Q, 31K)

Mirrors w/defrost, remote and video camera (requires Convenience Package)

Interior

Amplified digital HDTV antenna

Pleated night shades (lounge, dinette, and bedroom)

Mini blinds (galley, bath)

Systems monitor panel

Roof vent (bedroom and front bunk area)

Blackout cab divider curtain (22R, 25B, 31H)

Front wraparound curtain (27Q, 31K)

Tinted windows

Vinyl ceiling

USB charger

LED lighting

28" HDTV w/DVD player (22R, 25B)

32" HDTV w/DVD player (27Q, 31K, 31G)

Vinyl flooring throughout

Assist bar

Decorative wall decal (27Q, 31K)

OPTIONAL EQUIPMENT

Dual-glazed, thermo-insulated windows

Sofa sleeper (31K)

Galley

Microwave oven w/touch control

3-burner range top w/storage below

Vented range hood w/light

2-door refrigerator/freezer

Decorative backsplash

OPTIONAL EQUIPMENT

3-burner range w/oven

Microwave/convection oven w/touch control (27Q, 31K, 31G)

4-door refrigerator/freezer w/icemaker (31K, 31G)

Bath

Shower curtain (NA 31G)

Shower door (31G)

Flexible showerhead

Skylight

Towel ring

Powered roof vent

Toilet w/foot pedal

Tissue holder

Robe hook(s)

Towel bar(s) (31G)

Bedroom

Double bed w/foam mattress and mattress cover (22R, 25B)

Queen bed w/foam mattress and bedspread (27Q, 31K, 31G)

Headboard

Bunk beds w/covered foam mattresses, mattress covers, storage compartment, and privacy curtains (31G)

24" HDTV

Exterior

Premium high-gloss fiberglass skin

Porch light w/interior switch

Running boards

Large lighted trunk storage compartment

Patio awning

OPTIONAL EQUIPMENT

Powered patio awning w/LED lighting

Molded front cap

Heating & Cooling

20,000 BTU furnace (22R, 25B)

30,000 BTU furnace (27Q, 31K, 31G)

Coleman®-Mach® 15 A/C

Electrical System

AC/DC load center, 45-amp. converter/charger

30-amp. power cord

TV jack and AC receptacle near entrance door

Deep-cycle, Group 24 battery

Coach battery disconnect system

Automatic dual-battery charge control

4,000-watt Cummins Onan® Microquiet™ generator

Auxiliary start circuit

OPTIONAL EQUIPMENT

2 deep-cycle batteries included w/Convenience Package

Plumbing System

Pressurized city water hookup w/tank fill

On-demand water pump

6-gallon LP water heater w/electronic ignition

Permanent-mount LP tank w/gauge

Sewage pump (macerator) (27Q)

OPTIONAL EQUIPMENT

Heated electric drainage system

Safety

LP, smoke, and carbon monoxide detectors

10 BC fire extinguisher

Ground fault interrupter

Child seat tether anchor

Warranty⁷

12-month/15,000-mile basic limited warranty⁸

36-month/36,000-mile limited warranty on structure⁸

10-year limited parts-and-labor warranty on fiberglass roof⁸

FOOTNOTES

- The height of each model is measured to the top of the tallest standard feature and is based on the curb weight of a typically equipped unit. The actual height of your vehicle may vary by several inches depending on chassis or equipment variations. Please check with your dealer for further information.
- Floorplans feature a wide-body design - over 96" in making your purchase decision, you should be aware that some states restrict access on some or all state roads to 96" in body width. Before making your purchase decision, you should confirm the road usage laws in the states of interest to you.
- The load capacity of your motorhome is designated by weight, not by volume, so you cannot necessarily use all available space when loading your motorhome.
- Capacities are based on measurements prior to tank installation. Slight capacity variations can result due to installation applications.
- Capacities shown are tank manufacturer's listed water capacity (WC). Actual filled LP capacity is 80% of listing due to overfilling prevention device on tank.
- Actual towing capacity is dependent on your particular loading and towing circumstances which includes the GVWR, GAWR, and GCWR as well as adequate trailer brakes. Please refer to the Operator's Manual of your vehicle for further towing information.
- See separate chassis warranty.
- See your dealer for complete warranty information.

NA Not Available

Not all items available in combination. See dealer for details.

Winnebago's® continuing program of product improvement makes specifications, equipment, model availability, and prices subject to change without notice. Published content reflects the most current product information at time of printing. Please consult your dealer for individual vehicle features and specifications.





Let us host
your next

Adventure



WGOAdventures.com



Show your Winnebago love
with high-quality gifts and wearables.



Apparel | Gifts | Parts | Gear

WinnebagoOutdoor.com

Find your style



Connect with Winnebago (Click one of the following)



Like us



Follow us



Watch us

WinnebagoInd.com Has All The Answers

Visit WinnebagoInd.com on your computer, smartphone, or tablet for the latest product information and updates.

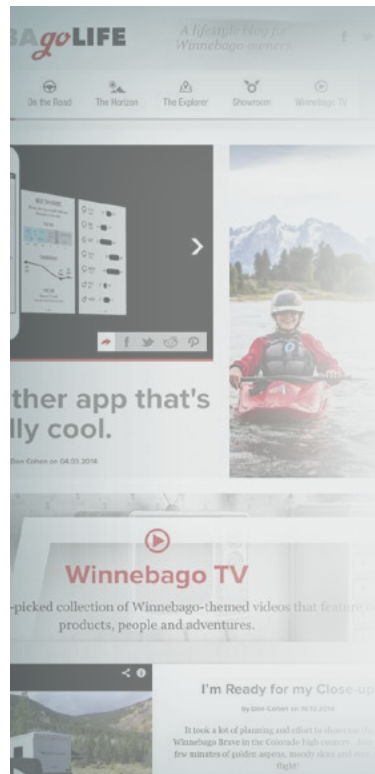

Welcome to GoLife!

Visit our lifestyle blog for motorhome news, personal travelogues, and community stories.

WinnebagoLife.com



PREFERRED CARE PROGRAM

We back our motorhomes with best-in-class support both before and after the sale:

- 12-month/15,000-mile basic limited warranty
 - 36-month/36,000-mile limited warranty on structure
 - 10-year limited parts-and-labor warranty on fiberglass roof
 - Complimentary 24-hour roadside assistance program
- TripSaver® Fast Track Parts guarantees that in-stock warranty parts ship directly to your dealer within 24 hours
 - National dealer service network



For more information, visit us
WGOService.com



From RV to personal insurance, Winnebago RV Insurance can provide all the coverage and services you need to feel at home on the road.

For more information:
(800) 642-4892



CONTACT US

GENERAL INQUIRIES

Corporate Switchboard
(641) 585-3535

CURRENT PRODUCT OWNER AND SERVICE-RELATED INQUIRIES

(800) 537-1885
or winnebagoind.com

NEW VEHICLE SALES INQUIRIES

sales@winnebagoind.com

FAX

(641) 585-6966

POSTAL ADDRESS

Winnebago Industries, Inc.
P.O. Box 152
Forest City, IA 50436

STREET ADDRESS

Winnebago Industries, Inc.
605 West Crystal Lake Road
Forest City, IA 50436



Join the Club, Join the Fun

Here's the perfect way to begin your life on the road as the owner of a new Winnebago – by joining the exclusive WIT Club. Start your adventure with other fun-loving WIT Club members from across the country and get the most out of your new Winnebago motorhome.



Members enjoy:

- Caravans and rallies
- Newsletters
- Local and state group activities
- RV travel benefits

See more at
WITClub.com



Grand National Rally

Each year, thousands of Winnebago owners descend upon Forest City, Iowa. Rally-goers enjoy an unforgettable week reconnecting with friends, taking tours, participating in activities, and more. Join the adventure next July!