



Bentley
PONTOONS

At Bentley, we're dedicated to superior quality, craftsmanship and customer service all done with the intent to create luxuriously affordable boats. Our dedication starts with our people. For these reasons and more, we choose to make many of our own components, such as, furniture, canvas work, tubes, and fence railing. Not only does this give us our own, unique look, with superior style and comfort, but it ensures that it saves you time, aggravation, and money. This helps equate to giving you the best value on the water. You get the ultimate luxury, performance, and ride quality at an affordable price. Our internal design, engineering and product development processes assure that you get superior quality construction and functionality. Simply put, we want you, your family and friends who boat with you to have an enjoyable, stress free and relaxing escape on the water. Our manufacturing team and headquarters is in Lexington, South Carolina. This team of highly skilled, trained, passionate and hard-working individuals pride themselves in creating and crafting an excellent product every day. Additionally, we invest in the best people and training for our office team of support and customer service people. We partner with our dealer network to service you after the sale with a superior experience.

Welcome to the family – enjoy your new Bentley.

GO AHEAD – GET THE BENTLEY!

From our Family of boaters to yours. Enjoy your time on the water.



AFFORDABLE LUXURY

Why a Bentley pontoon should be your next boat...

1. Bentley boats are affordable and have excellent resale value years later.
2. Bentley boats have less maintenance and lower maintenance costs than most boats. Cost of ownership is lower.
3. Bentley boats are easy to board and exit. Our boats offer a stable, secure platform to move around on for worry-free and hassle-free boating.
4. Bentley boats are versatile. ONE boat can be used for: cruising, watersports, skiing, wakeboarding, fishing, entertaining, “chilling” at the sand bar or socializing with family and friends.
5. Bentley boat hulls are fuel efficient. Fuel consumption is minimal for less time at the fuel dock. They are also easy to fuel up.
6. Bentley boats have minimal bow rise unlike traditional fiberglass boats which gives you a safer boating experience.
7. Bentley boats have large, easy access storage and lots of it. There is plenty of room for bags, coolers, towels, boating toys, etc.
8. Bentley boats are easier to operate and navigate. Maneuverability is better, slow speed handling is a breeze and they are simpler to dock.
9. Bentley boats have much more interior space than traditional boats. Seating is more plush, stylish, and comfortable.
10. Bentley boats are easy to clean and maintain. Flooring and vinyls are mildew and stain resistant.
11. Bentley boats offer a more stable and safer platform. The furniture is comfortable, stylish, and easy to keep clean.
12. Bentley boats offer a safer “place to roam” for children and pets. Higher fence panels with “lift and lock” doors, along with soft, plush, durable furniture, give you additional peace of mind.

Table of Contents

Series	Model	Page(s)
General	The Bentley Hull/Chassis	2&3
General	Bentley Hull Configurations	4&5
ELITE	220 and 250 Admiral	6&7
ELITE	220 and 250 Swingback	8&9
ELITE	220 and 250 Rear Lounger	10&11
BENTLEY	200, 220 and 240 Cruise	12&13
BENTLEY	200, 220 and 240 Navigator	14&15
BENTLEY	220 and 240 Swingback	16&17
FISH	200, 220 and 240 Fish	18&19
FISH	220 and 240 Fish N Cruise	20&21
FISH	200, 220 and 240 4-Point	22&23
LE	180 and 200 CR	24&25
LE	180 3-Point	26&27
LE	200 CW	28-29
General	Floorplan and Specs	30-34
General	Flooring and Panel Options	35
General	Option Images	36-37



THE BENTLEY HULL and CHASSIS

Your Foundation for Quality, Comfort, Performance and Handling.

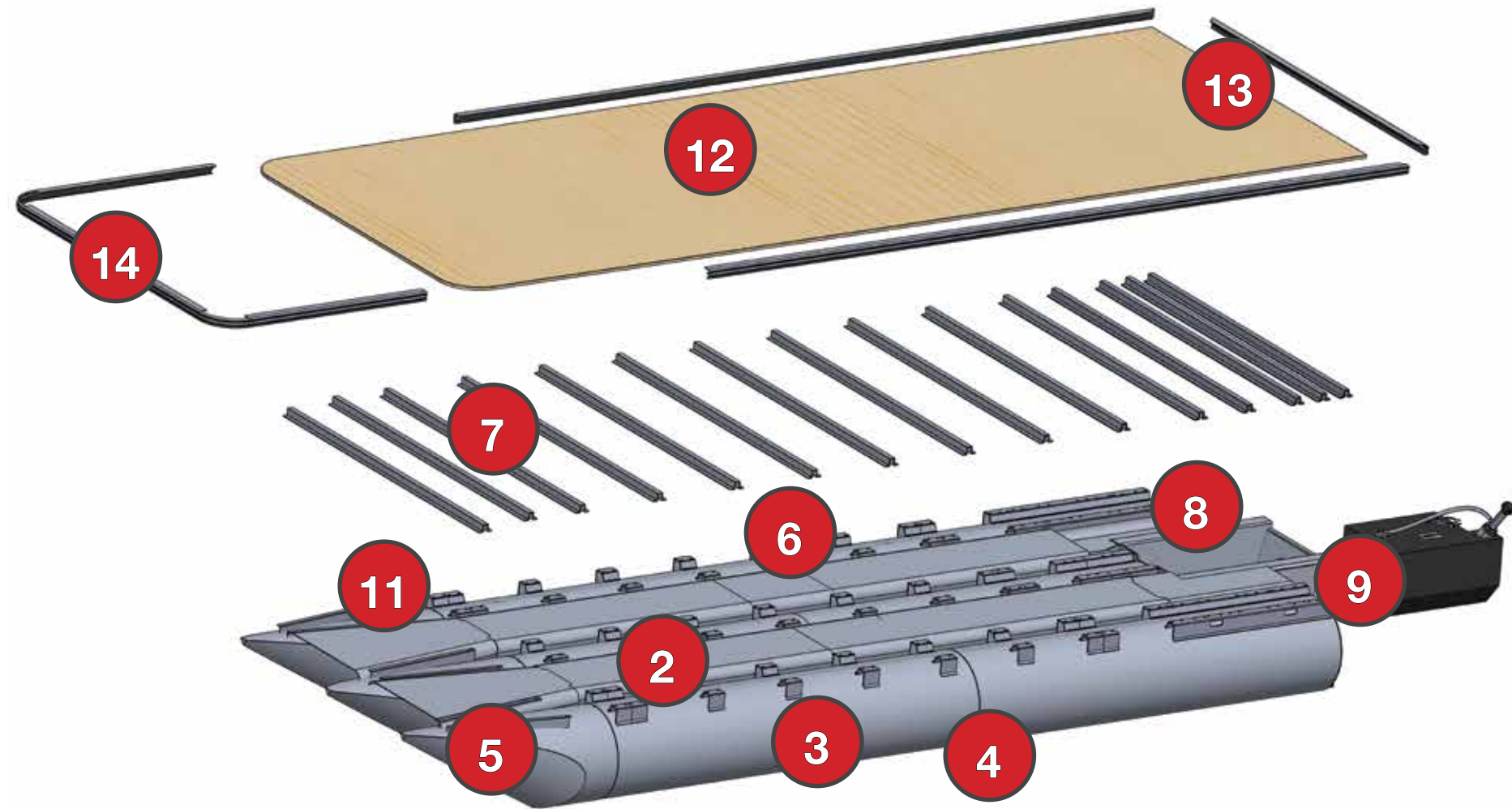

Bentley designed our .125 or .190 "hat" channel with two support bolts. Butyl tape is applied to seams for added waterproofing.

"C" or "U" channel. "Z" channel.



What Bentley's Competitors use.

Inferior shaped and engineered crossmember or cross channel utilizing only one support bolt.

Item	Feature	Feature Details
1	Keel	All our tubes feature a 5/8" full length, solid keel.
2	Tube diameter and thickness	25" diameter tubes are constructed from .080 thick aluminum sheet.
3	Lifting strakes or performance lifting strakes	.100 thick aluminum lifting strakes are optional on 2-tube hulls and standard on 3-tube hulls. Our lifting strakes are strategically placed on the tube and hydrodynamically designed to create "lift" which reduces drag, increases speed and improves maneuverability.
4	Tube baffles	Each joint of the tube has a baffle for added strength. The baffle has a drain hole for servicability.
5	Nose cones	All our nose cones have splash fins along with a proprietary keel for added strength and rigidity.
6	Cross member risers	It is important for all chassis to flex, but remain solid and intact. For this reason, the Bentley chassis uses multi length "M" bracket risers, strategically placed and welded to the tube, for added strength.
7	Cross members	.190 thick aluminum extruded "hat" channel cross members are used in the stem and .125 aluminum extruded elsewhere.
8	Transom and motor pod	Our boats have an all welded, aluminum transom, which utilizes .190 aluminum sheet in the motor pod area for maximum strength. * excluding LE models
9	Fuel tanks	All Bentley fuel tanks are roto molded for maximum quality and fitment. They are mounted in the motor pod and are diurnal EPA certified.
10	Wiring and harnesses	Deutsch - style electrical connectors are used to ensure quality.
11	Aluminum underskin	.063 thick aluminum sheet is fastened, using marine grade stainless steel rivets, to the underside of the decking/cross members. This underskin helps to reduce turbulence, noise, spray and increase speed.
12	Decking	3/4"- 7-Ply marine grade plywood is used for the decking material.
13	Beam	Every Bentley chassis features a 8'6" beam. This is the maximum width allowed for towing a boat without a special permit.
14	Rub rail	All our boats come standard with a rubber insert engineered into the rub rail.
15	Hardware	100% of all nuts, bolts and fasteners on the chassis are stainless steel.

* PRODUCT SPECIFICATIONS ARE SUBJECT TO CHANGE WITHOUT NOTICE.

Choose the hull and options designed and engineered to fit your boating style.

When it comes to hull options, you are the boss. Each Bentley boat hull can be customized to fit your personal boating choices. You can choose the options that are best suited to fit your needs and budget. You choose if you want analog instrumentation or digital. Obviously, there are some limitations, but you have endless options – and we know you like having options.

More than 50% of the time, our customers choose to have three tubes under the deck, but our two tubes hulls perform excellent. Our two tube hulls offer lots of options, like, under skin, lifting strakes, hydraulic steering, even ladder options.

Our three tube hulls offer the greatest flexibility and option selection. Do you want maximum speed? We got that. Do you want best overall maneuverability? Got that too. How about style and performance? Yes, we have that. Our offering allows you to choose “in-floor” storage, performance lifting strakes, power-steering, even telescoping ladders. Since it’s your boat, customize it to fit your needs. No matter what you choose for options, our Bentley hull has a lifetime warranty for a lifetime of family fun.

- Bentley hulls:
- XLP3
 - SPORT3
 - 2-TUBE

XLP3 HULL

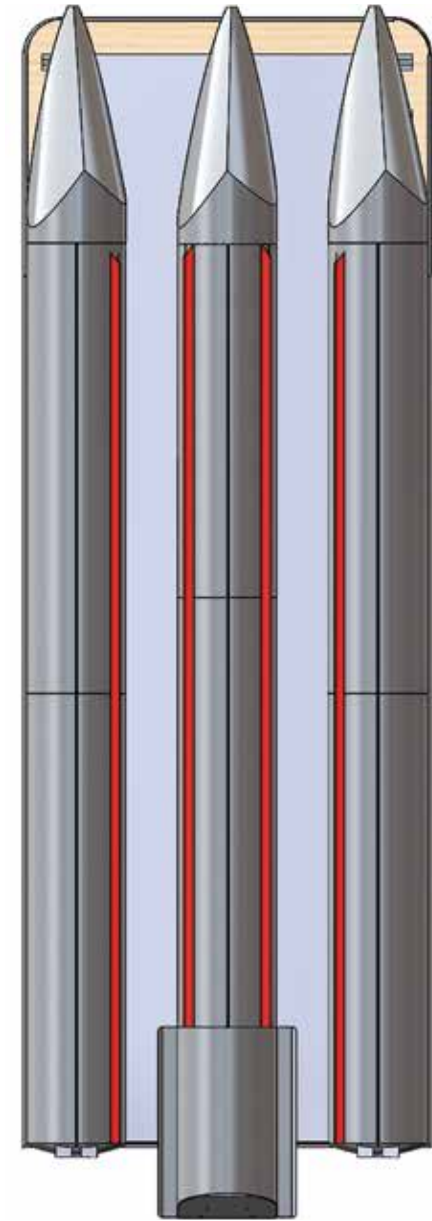

XLP3 UNDERSIDE VIEW

XLP3 Hull

This Xtra Luxurious Performance Triple toon provides the ultimate ride in boating. Choose this hull for rougher water, hard-core water sports or a comfortable cruise. The XLP3 hull is available on Bentley and Elite models.

- (3) 25” diameter round tubes with a 25” shaft transom - STANDARD.
- All welded aluminum transom with built-in 54-gallon fuel tank and “U-shaped” motor pod - STANDARD.
- Aluminum under skin to increase speed, reduce turbulence, noise, and spray - STANDARD.
- Lifting strakes strategically placed on the tube for “lift,” speed and less drag - STANDARD.
- Center tube “in-floor” storage area for ski’s, water toys, etc. - OPTIONAL.
- ¾” – 7-ply marine grade plywood with a lifetime warranty - STANDARD.



XLP3 STERN VIEW

*The images shown may include optional equipment.

SPORT3 HULL

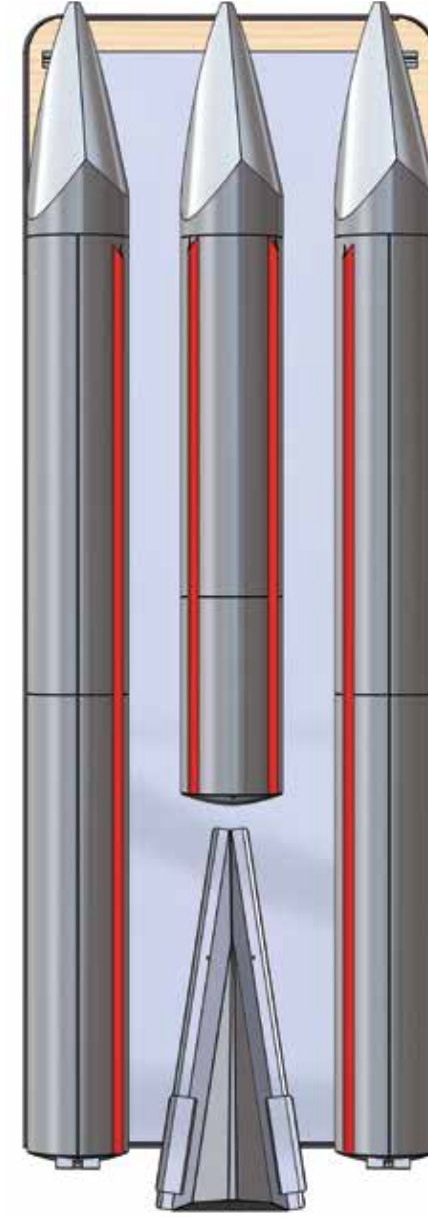

SPORT3 UNDERSIDE VIEW

SPORT3 Hull

This agile High Performing Triple toon provides great top-end speed. Its lighter weight enhances fuel economy and it has an economical price. Choose this hull for water sports, speed, and cruising. The SPORT3 hull is available on Fish, Bentley, and Elite models.

- (3) 25” diameter round tubes with a 20” shaft transom -STANDARD.
- All welded aluminum transom with built-in 32-gallon fuel tank and “Vshaped” motor pod -STANDARD.
- Aluminum under skin to increase speed, reduce turbulence, noise, and spray -STANDARD.
- Lifting strakes strategically placed on the tube for “lift,” speed and less drag. -STANDARD.
- Center tube “in-floor” storage area for ski’s, water toys, etc. -OPTIONAL.
- ¾” – 7-ply marine grade plywood with a lifetime warranty -STANDARD.



SPORT3 STERN VIEW

*The images shown may include optional equipment.

2-TUBE HULL

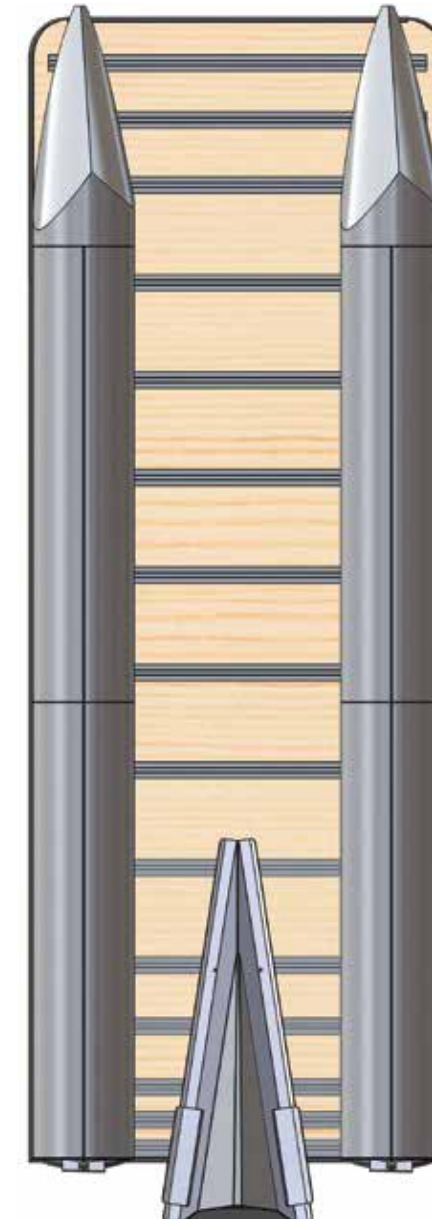

2-TUBE UNDERSIDE VIEW

2-Tube Hull

This proven, durable, hydrodynamic hull is a great all-around performer. Its rugged and safe design is trusted by all. Choose this hull for a relaxing cruise, entertaining, basic water sports, and comfort. The 2-tube hull is available on LE, Fish, Bentley, and Elite models.

- (2) 25” diameter round tubes with a 20” shaft transom -STANDARD.
- All welded aluminum transom with built-in 18 or 32-gallon fuel tank and “V-shaped” motor pod -STANDARD.
- Aluminum under skin to increase speed, reduce turbulence, noise, and spray -OPTIONAL.
- Lifting strakes strategically placed on the tube for “lift,” speed and less drag. -OPTIONAL.
- ¾” – 7-ply marine grade plywood with a lifetime warranty -STANDARD.



2-TUBE STERN VIEW

ELITE ADMIRAL

Sleek and stylish, the Elite Admiral Series offers comfortable seating and plenty of amenities. This specific model offers a center walk through floorplan with dual captain's chairs and is finished with an extended rear deck. You're sure to enjoy superior performance, capability and comfort all while cruising on an Elite Admiral.



220 ADMIRAL

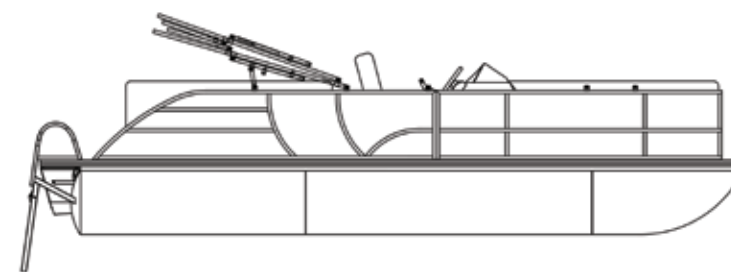
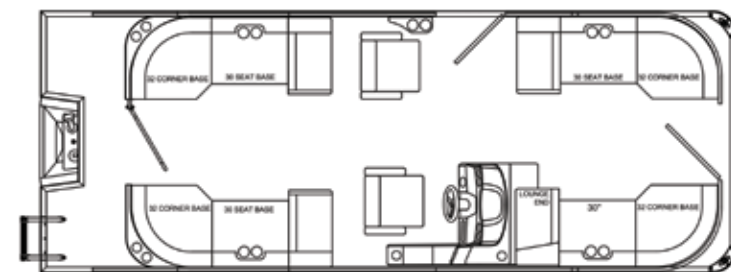

250 ADMIRAL

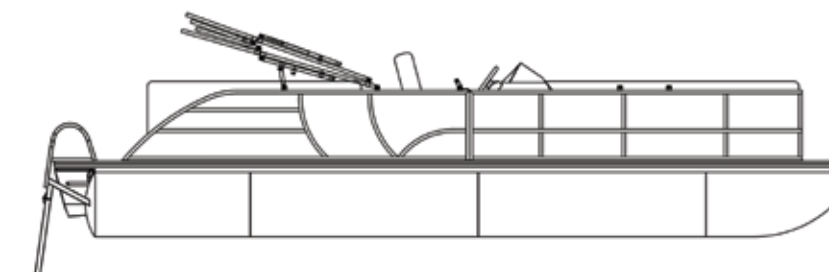
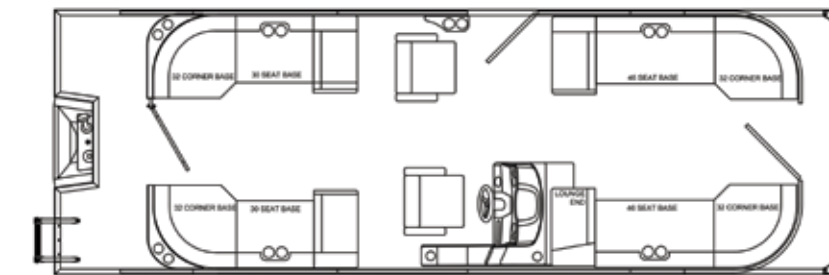

ELITE SWINGBACK

The Elite Swingback is available with either dual captain chairs or companion bench seating. It offers superior comfort, performance and style. Swingbacks deliver a smooth ride with versatile, multi-directional seating. The dual captain chairs or the companion bench seating is perfect for a full day on the water.



SWINGBACK BENCH
(AVAILABLE in 220 AND 250 MODELS)

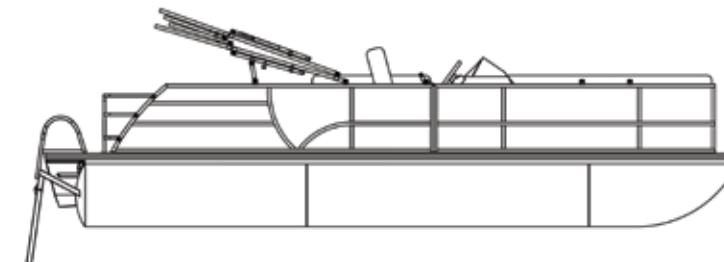
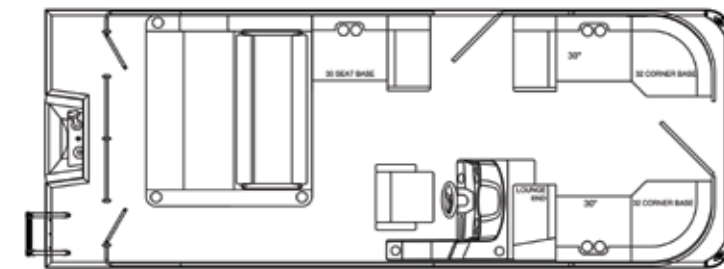

SWINGBACK DUAL CAPTAIN
(AVAILABLE in 220 AND 250 MODELS)

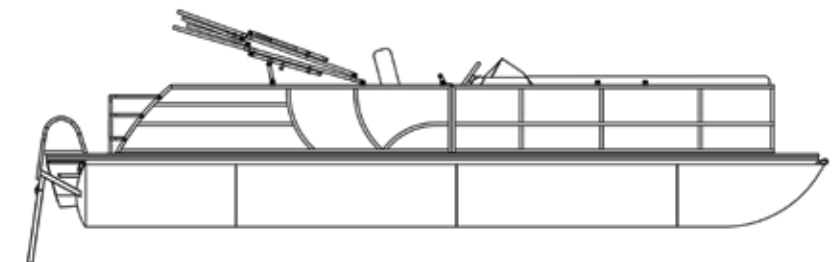
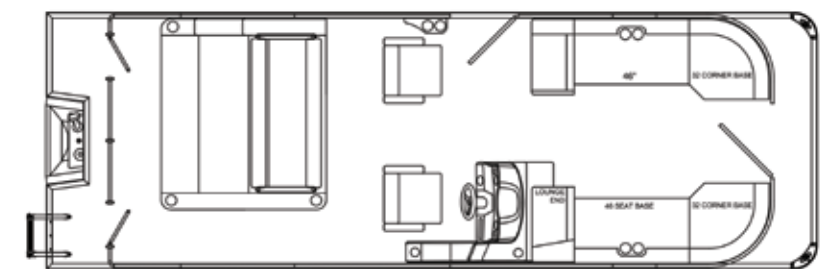

ELITE REAR LOUNGER

Life becomes a retreat on board the Elite Rear Lounger Series. With spacious, luxury bench seating up front, coupled with dual captain's chairs and twin rear chaise loungers, you're guaranteed to enjoy this roomy and well laid out pontoon.



220 REAR LOUNGER

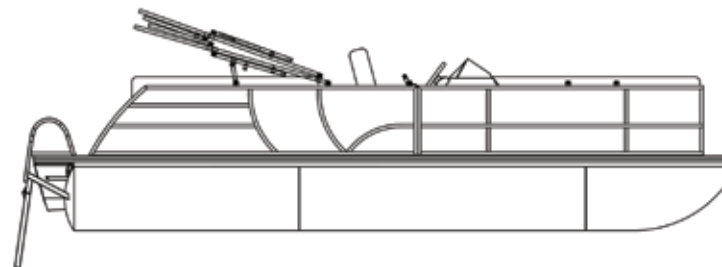
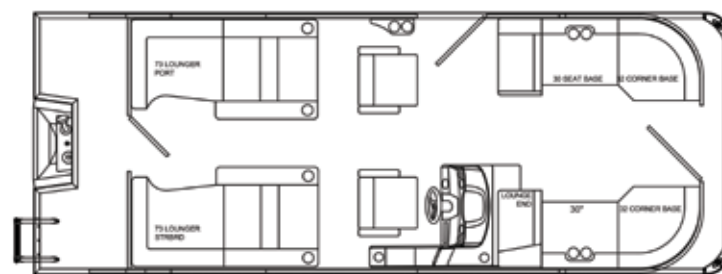

250 REAR LOUNGER

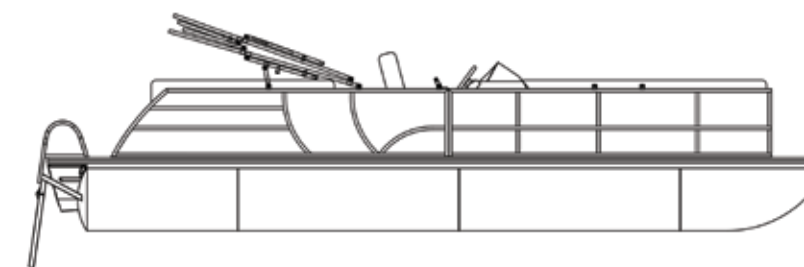
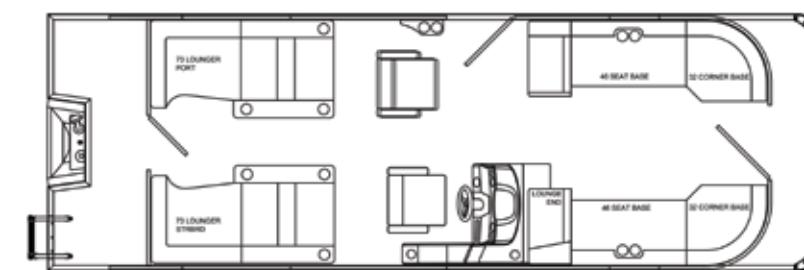

BENTLEY CRUISE

The Bentley Cruise offers a traditional rear “L” Section seating and sun deck with plenty of storage. Hop on board a Bentley Cruise and discover the classic styling and legendary quality you’ve come to know and trust from Bentley Pontoons.



200 CRUISE

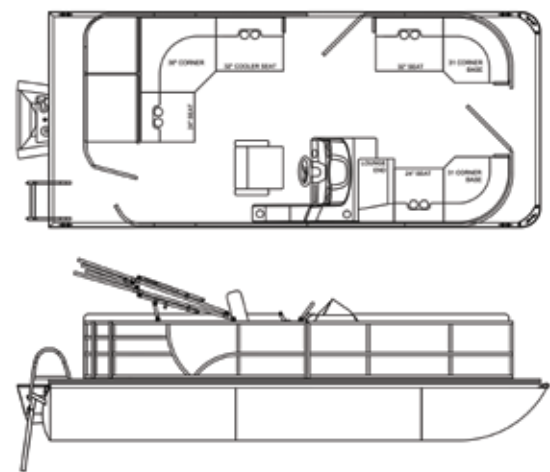

220 CRUISE

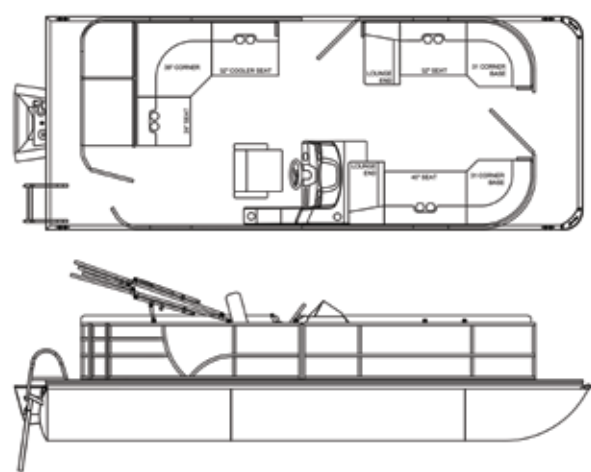

240 CRUISE

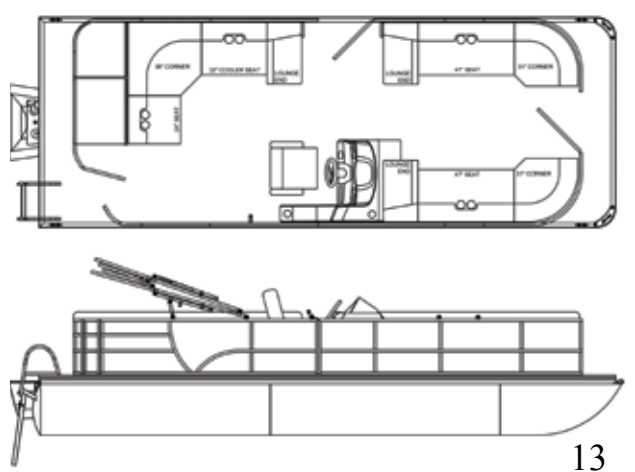

BENTLEY NAVIGATOR

The Bentley Navigator Series offers a traditional center walk through floor plan with dual captain's chairs and an extended rear deck. Navigator Models offer performance, enhanced style and outstanding fit and finish. Navigating fun has never been easier and more enjoyable!



200 NAVIGATOR

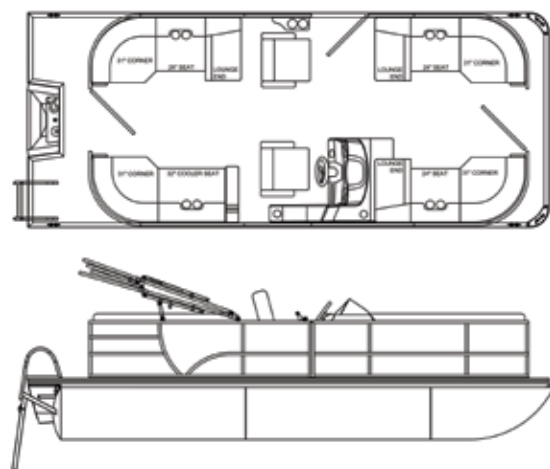

220 NAVIGATOR

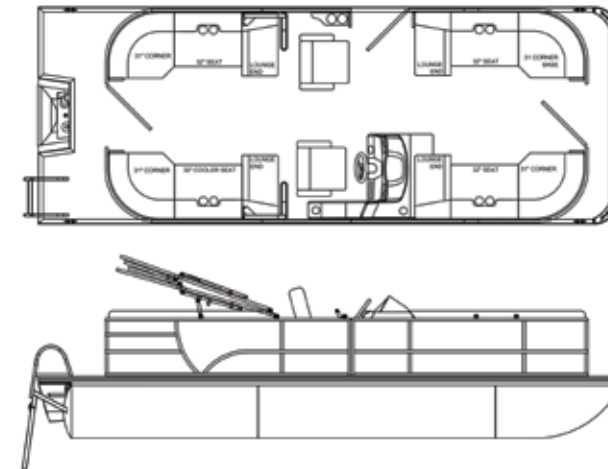

240 NAVIGATOR

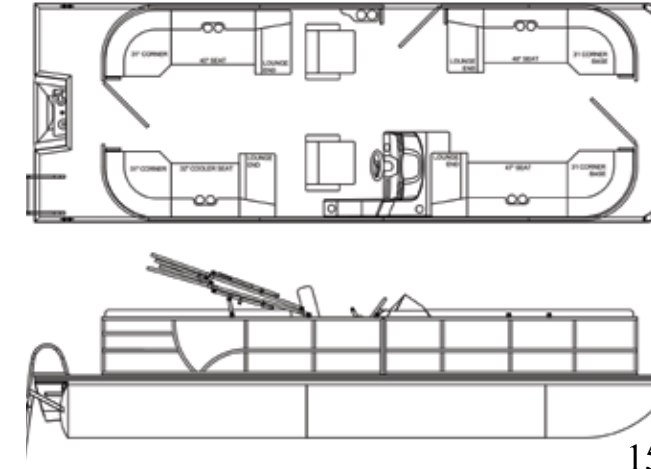

BENTLEY SWINGBACK

The Bentley Swingback is designed to deliver a smooth ride with flexible, multi-directional swingback seating and dual captain chairs. Navigating a good time and making memories has never been more fun.



220 SWINGBACK

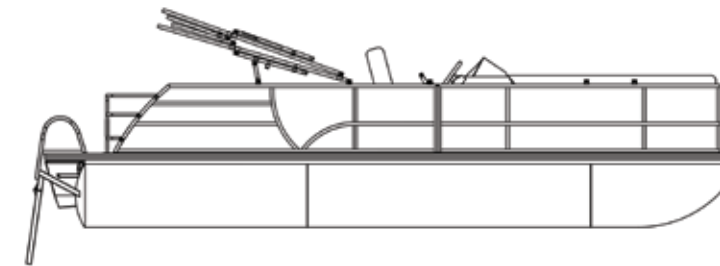
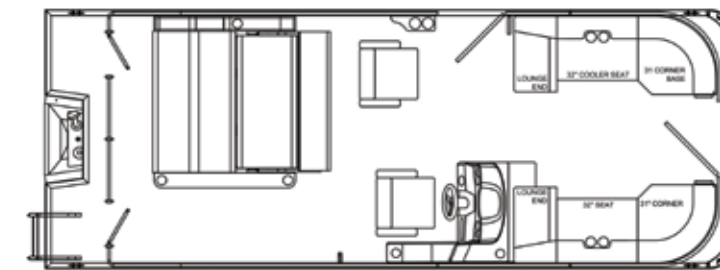

240 SWINGBACK

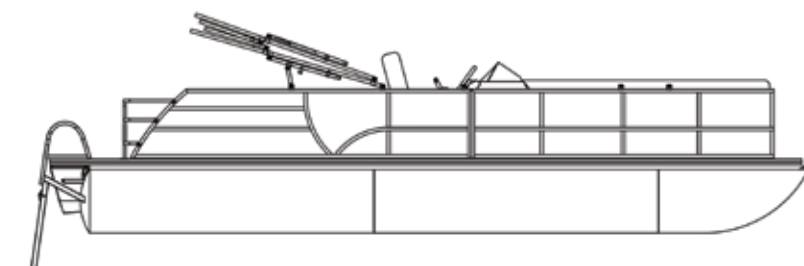
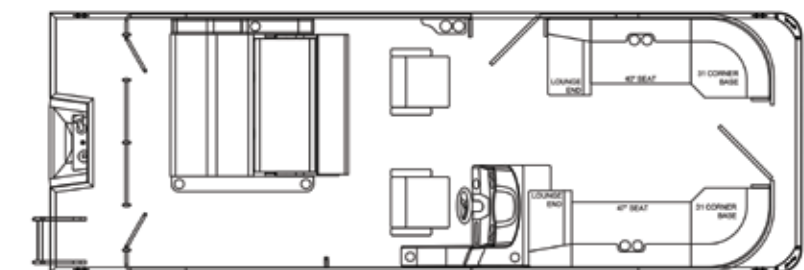

FISH SERIES FISH

With the Fish Series, you will be ready for any occasion. This floorplan offers the best of both worlds, as it has a fishing front end coupled with an “L” Section in the stern. Depending on what your weekend adventures entail, there is plenty of room for fishing, cruising and relaxing.



200 FISH

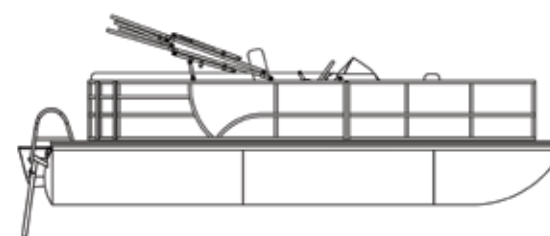
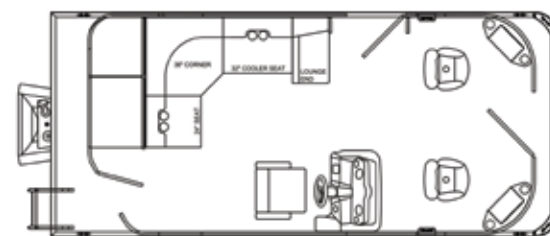

220 FISH

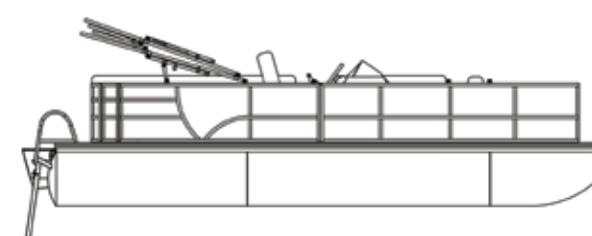
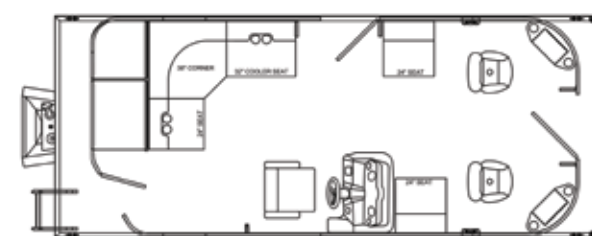

240 FISH

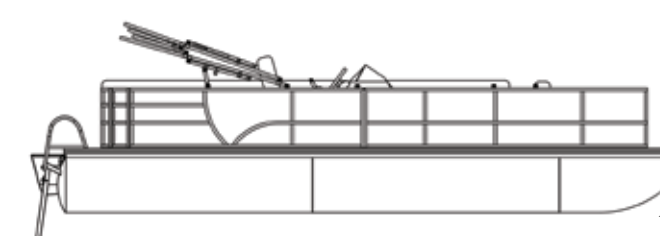
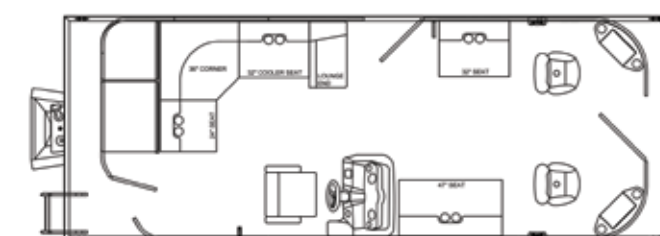

FISH SERIES FISH N CRUISE

With the Fish N Cruise Series, you will be ready for any occasion. This floorplan offers the best of both worlds, as it has a Cruise front end and "L" Section coupled with two rear fishing seats and bait station aft. Depending on what your weekend adventures entail, there is plenty of room for fishing, cruising and relaxing.



220 FISH N CRUISE

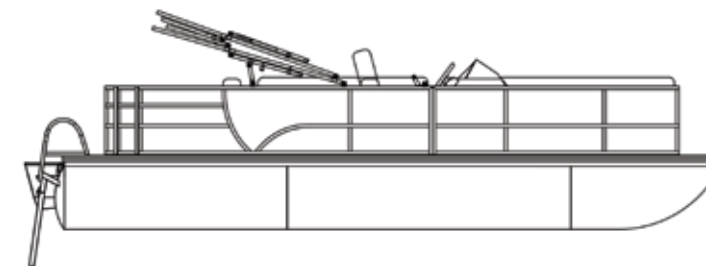
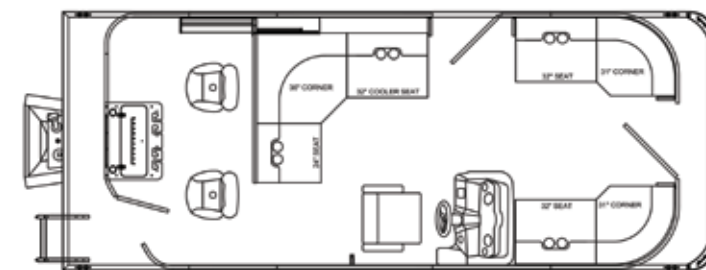

240 FISH N CRUISE

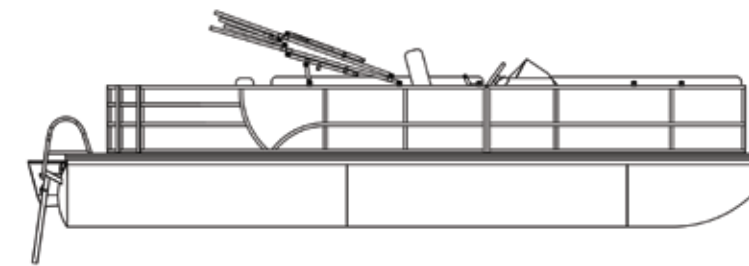
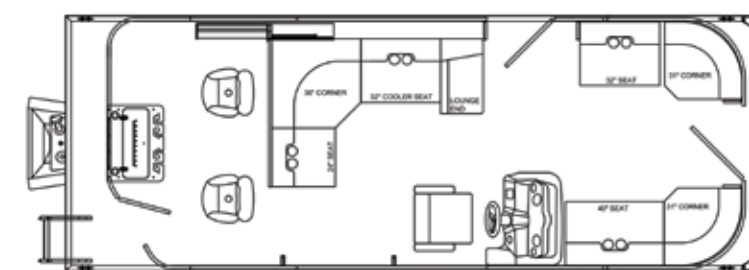

FISH SERIES 4-POINT

The 4-Point Fish Series provides you four great points to fish from. The traditional “L” seating coupled with fishing seats in all four corners, offers the perfect boat for the avid fisherman. The comfortable seating and open floor plan makes it easy to maneuver throughout the boat for days on the water.



200 4 POINT

220 4 POINT

240 4 POINT

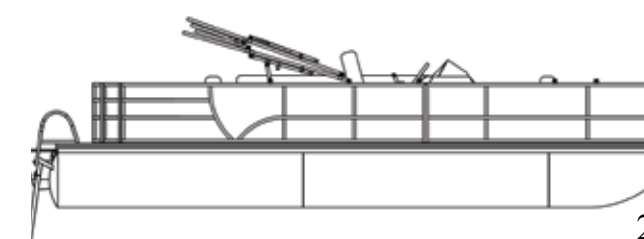
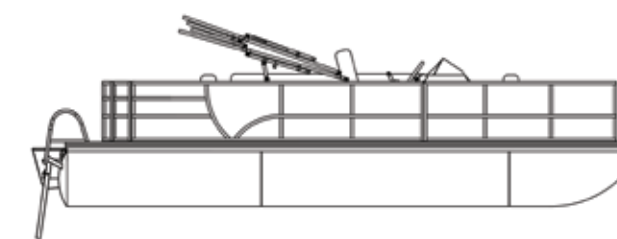
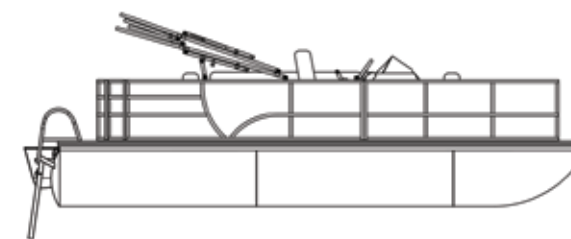
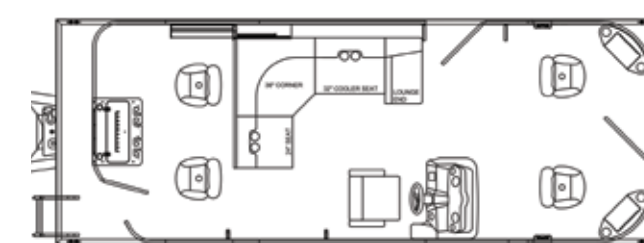
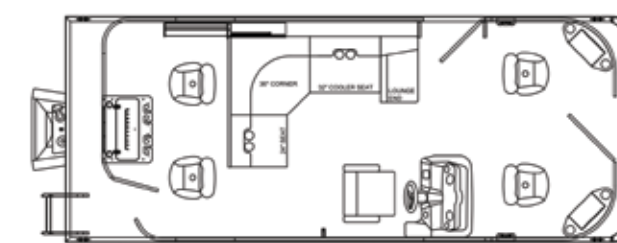
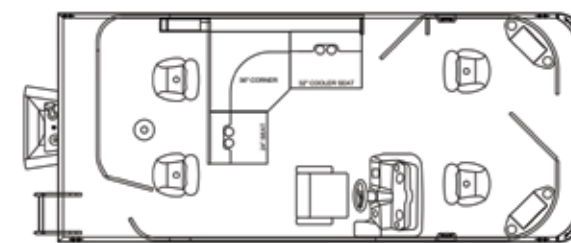

LE SERIES CR

The LE CR provides a great escape with the family out on the water. Whether it's cruising around on the lake or tied up at the sandbar, these pontoons are perfect for a day of fun. If you're looking for a compact fishing pontoon, the LE CR has just the right setup for a day on the lake.



180 LE CR

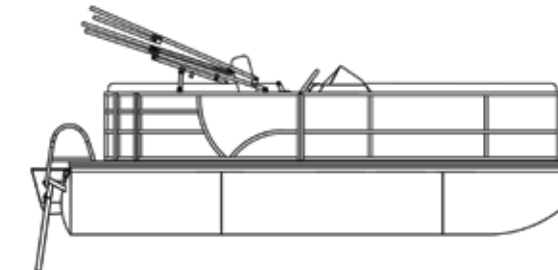
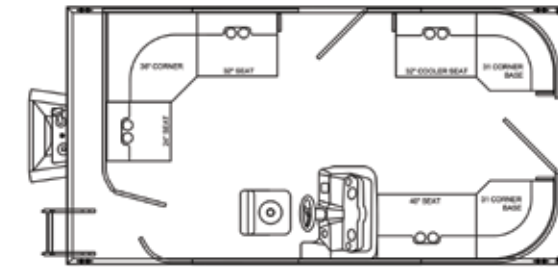

200 LE CR

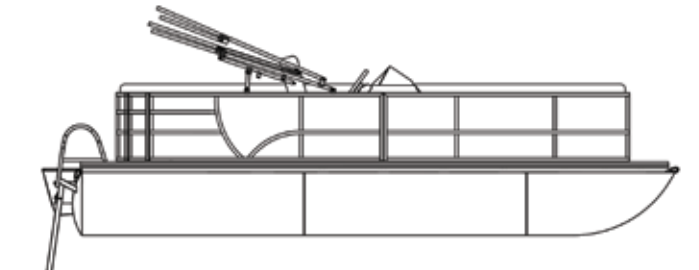
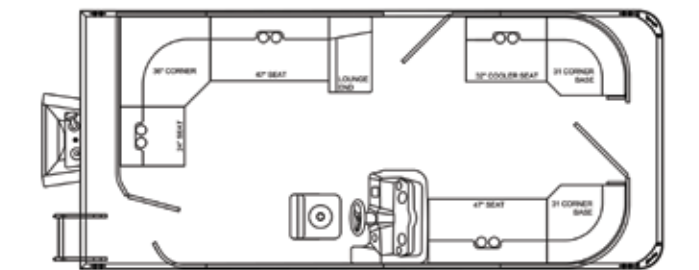

LE SERIES 3-POINT

The LE 3-Point is one of the most versatile pontoons, whether it's cruising around on the lake or tied up at the sandbar, these pontoons are destined for a day of fun. If you're looking for a compact fishing pontoon, a cruise around the lake pontoon or a pontoon to take to the sandbar, the LE 3-Point



180 LE 3-POINT

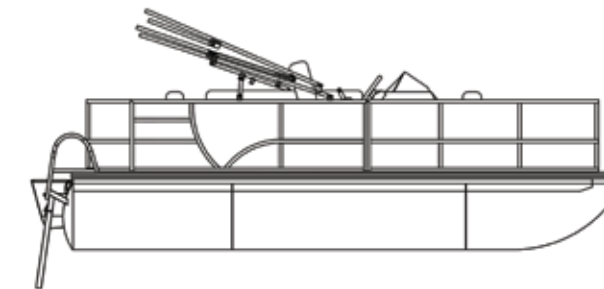
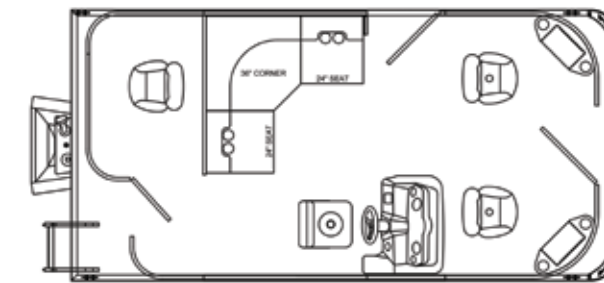

LE SERIES CW

The LE Center Walk Through is a great choice when you are looking for a fun filled day on the water with family or a group of friends. Extremely versatile, whether it's cruising around on the lake or tied up at the sandbar, these pontoons are loaded for fun.



200 CW

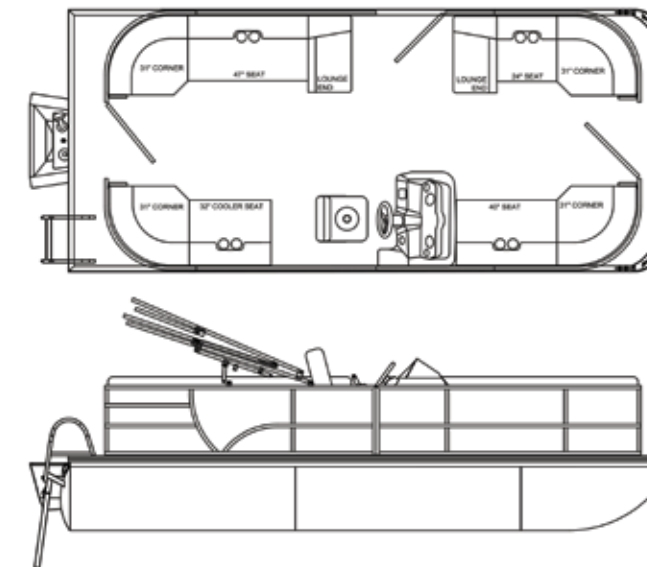

Elite Series

22'
MODELS

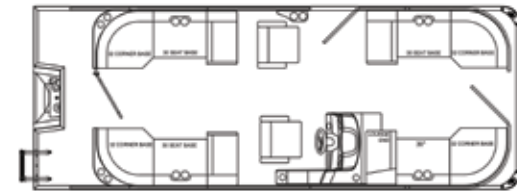

220 ADMIRAL

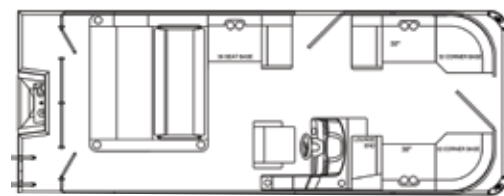

SWINGBACK BENCH
(AVAILABLE in 220 and 250)

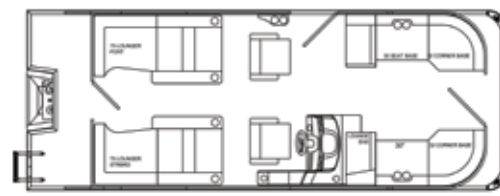

220 REAR LOUNGER

25'
MODELS

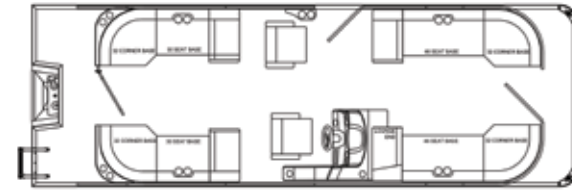

250 ADMIRAL

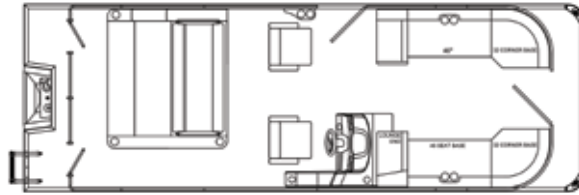

SWINGBACK DUAL CAPTAIN
(AVAILABLE in 220 and 250)

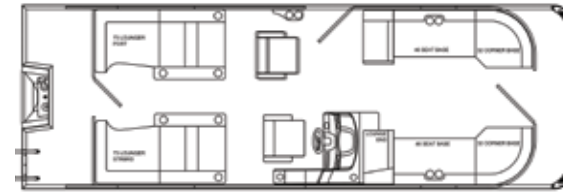

250 REAR LOUNGER

Bentley Series

20'
MODELS

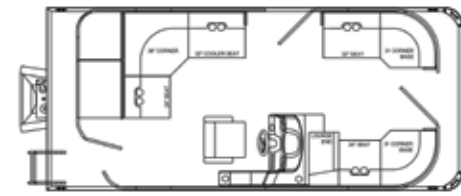

200 CRUISE

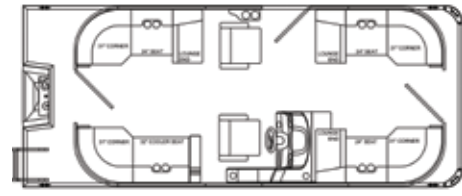

200 NAVIGATOR

22'
MODELS

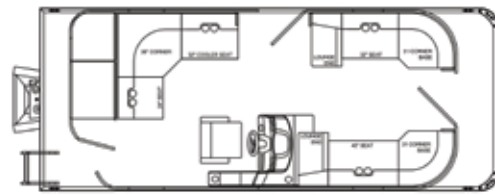

220 CRUISE

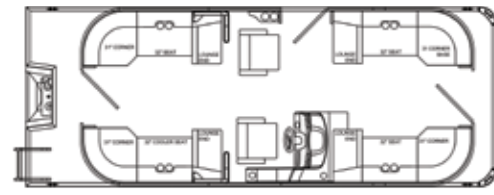

220 NAVIGATOR

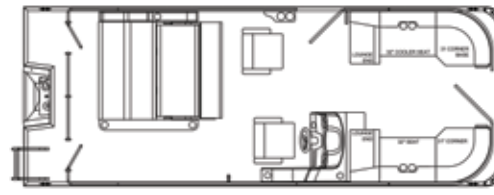

220 SWINGBACK

24'
MODELS

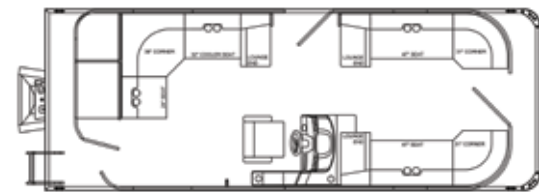

240 CRUISE

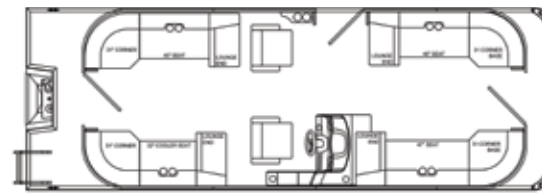

240 NAVIGATOR

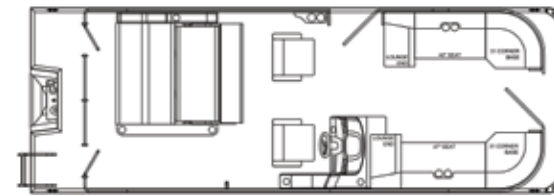

240 SWINGBACK

Fish Series

20'
MODELS

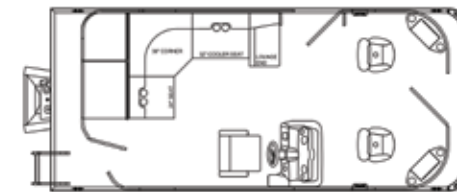

200 FISH

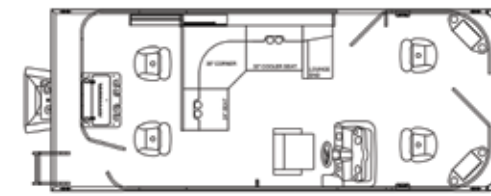

200 4 PT

22'
MODELS

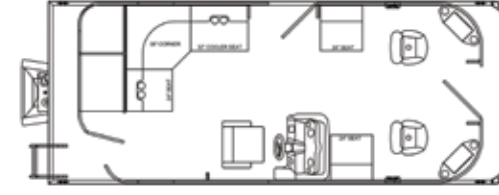

220 FISH



220 FNC

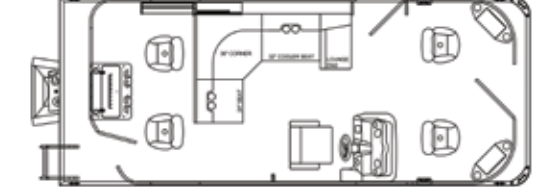

220 4 PT

24'
MODELS

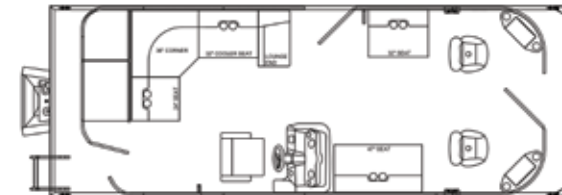

240 FISH

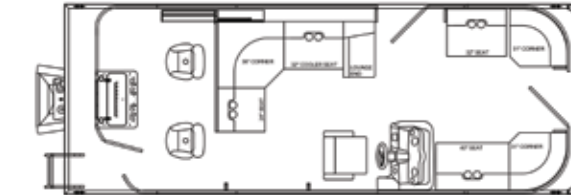

240 FNC

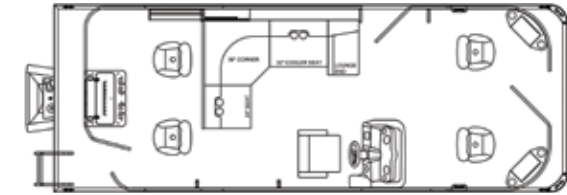

240 4 PT

LE Series

18'
MODELS

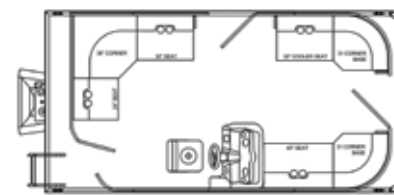

180 LE CR

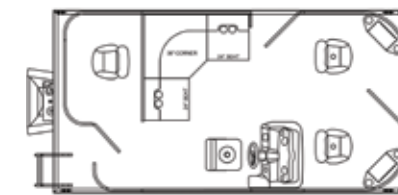

180 LE 3 PT

20'
MODELS

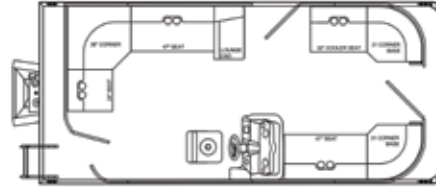

200 LE CR

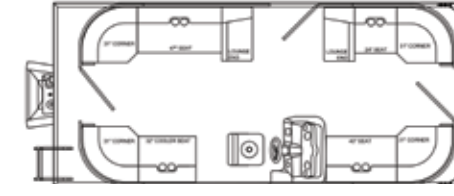

200 LE CW

SPECIFICATIONS

Pontoon Diameter
 Pontoon Gauge
 Beam
 Fuel Capacity (Gal)
 Overall Length (no engine)
 Pontoon Length
 Deck Length (*= Ext Deck Model)
 Approximate Dry Weight (no engine)
 Person Capacity
 Max LBS
 Shaft Motor
 Max HP

LE Series	Pontoon Diameter	Pontoon Gauge	Beam	Fuel Capacity (Gal)	Overall Length (no engine)	Pontoon Length	Deck Length (*= Ext Deck Model)	Approximate Dry Weight (no engine)	Person Capacity	Max LBS	Shaft Motor	Max HP
LE 180	25"	0.080	8'6"	18	18'4"	17'10"	17'1"	1580	8	1360	20"	60
LE 200	25"	0.080	8'6"	18	20'8"	20'	19'5"	1850	11	1870	20"	90
Fish Series	Pontoon Diameter	Pontoon Gauge	Beam	Fuel Capacity (Gal)	Overall Length (no engine)	Pontoon Length	Deck Length (*= Ext Deck Model)	Approximate Dry Weight (no engine)	Person Capacity	Max LBS	Shaft Motor	Max HP
Fish 200	25"	0.080	8'6"	32	20'8"	20'	19'5"	1860	12	2040	20"	115
Fish 203 (SPORT3)	25"	0.080	8'6"	32	20'8"	20'	19'5"	2160	12	2040	20"	150
Fish 220	25"	0.080	8'6"	32	22'8"	22'	21'6"	2180	12	2040	20"	150
Fish 223 (SPORT3)	25"	0.080	8'6"	32	22'8"	22'	21'6"	2480	12	2040	20"	200
Fish 240	25"	0.080	8'6"	32	24'8"	24'	23'5"	2180	14	2380	20"	150
Fish 243 (SPORT3)	25"	0.080	8'6"	32	24'8"	24'	23'5"	2480	14	2380	20"	250
Bentley Series	Pontoon Diameter	Pontoon Gauge	Beam	Fuel Capacity (Gal)	Overall Length (no engine)	Pontoon Length	Deck Length (*= Ext Deck Model)	Approximate Dry Weight (no engine)	Person Capacity	Max LBS	Shaft Motor	Max HP
Bentley 200	25"	0.080	8'6"	32	20'8"	20'	19'5" / *20'8"	1900	14	2380	20"	115
Bentley 203 (SPORT3)	25"	0.080	8'6"	32	20'8"	20'	19'5" / *20'8"	2200	14	2380	20"	150
Bentley 220	25"	0.080	8'6"	32	22'8"	22'	21'6" / *22'8"	2180	15	2550	20"	150
Bentley 223 (SPORT3)	25"	0.080	8'6"	32	22'8"	22'	21'6" / *22'8"	2480	15	2550	20"	200
Bentley 223 (XLP3)	25"	0.080	8'6"	54	23'2"	22'	21'6" / *22'8"	2680	15	2550	25"	250
Bentley 240	25"	0.080	8'6"	32	24'8"	24'	23'5" / *24'8"	2240	16	2720	20"	150
Bentley 243 (SPORT3)	25"	0.080	8'6"	32	24'8"	24'	23'5" / *24'8"	2540	16	2720	20"	250
Bentley 243 (XLP3)	25"	0.080	8'6"	54	25'2"	24'	23'5" / *24'8"	2740	16	2720	25"	250
Elite Series	Pontoon Diameter	Pontoon Gauge	Beam	Fuel Capacity (Gal)	Overall Length (no engine)	Pontoon Length	Deck Length (*= Ext Deck Model)	Approximate Dry Weight (no engine)	Person Capacity	Max LBS	Shaft Motor	Max HP
Elite 220	25"	0.080	8'6"	32	22'8"	22'	22'8"	2280	15	2550	20"	150
Elite 223 (SPORT3)	25"	0.080	8'6"	32	22'8"	22'	22'8"	2580	15	2550	20"	200
Elite 223 (XLP3)	25"	0.080	8'6"	54	23'2"	22'	22'8"	2780	15	2550	25"	250
Elite 250	25"	0.080	8'6"	32	25'8"	25'	25'8"	2560	16	2720	20"	175
Elite 253 (SPORT3)	25"	0.080	8'6"	32	25'8"	25'	25'8"	2860	16	2720	20"	250
Elite 253 (XLP3)	25"	0.080	8'6"	54	26'3"	25'	25'8"	3060	16	2720	25"	300

2022 Standard Features	LE Series	Fish Series	Bentley Series	Elite Series
5-Year Bow to Stern Warranty (Limited)	■	■	■	■
3/4" - 7 Ply Marine Grade Plywood W/ Lifetime Warranty	■	■	■	■
25" Diameter Tubes W/ Lifetime Warranty (Workmanship)	■	■	■	■
5/8" Full Solid Keel	■	■	■	■
All Welded Aluminum Transom W/Built-In Fuel Tank W/ Lifetime Warranty (Workmanship)	■	■	■	■
Composite Built in Fuel Tank Size (Gallons)	18	32 / 54 (2-tube & SPORT3)/XLP3	32	32 / 54 (2-tube & SPORT3)/XLP3
.190 Hat Channel Crossmembers at Motor Mount Area		■	■	■
Powder Coat Railing	■	■	■	■
Custom Fiberglass Console	■	■	■	■
OEM Analogue Gauges		■	■	
OEM Digital Multi-Function Gauge				■
Speedometer, Tachometer, Voltage & Fuel	■	■	■	■
Simrad Go7 Screen W/ Chart Plotter, Depth & More		Opt.	Opt.	■
Switchpanel W/ Easy Access Resettable Breakers	■	■	■	■
Stereo System	JBL PRV125	JBL PRV125	JBL PRV125	Rockford PMX2
# Speakers	4	4	4	6
12 Volt Receptacle W/ Dual USB Charging Ports	■	■	■	■
LED Navigation Lights & LED Docking Lights	■	■	■	■

2022 Standard Features	LE Series	Fish Series	Bentley Series	Elite Series
Sealed "Deutsch" Style Electrical Connectors	■	■	■	■
Mechanical Tilt Steering	Opt.	■	■	
Seastar Hydraulic Steering W/ Tilt		Opt.	Opt.	■
10' Bimini W/ Quick Disconnect (LE is 9')	■	■	■	■
Rotocast Furniture Bases	■	■	■	■
Integrated Cupholders	■	■	■	■
Deluxe Highback Elite Captains Chairs				■
Premium Furniture W/ Upholstered Bases				■
Rear Entry W/ Ladder	■	■	■	■
Stainless Steel Ladder		Opt.	Opt.	■
Stainless Steel Flip-Up Cleats		Opt.	Opt.	■
Fishing Chairs		■		
Built-in Livewell		■		
Table W/ Cupholders	■	■	■	■
Standard Flooring	Seagrass	Seagrass/Vinyl	Seagrass	Seagrass
Bumper Guard W/ Rubber Insert	■	■	■	■
Standard Helm Seating	Fish Chair	Midback	Midback	DLX Highback
1/2 Gate (standard if ordered trolling motor pre-rig OR requested)		Opt.		

FLOOR COVERING OPTIONS

Recommended for Tan Interior Upholstery



SEAGRASS TAN

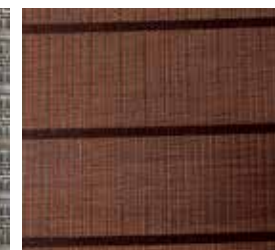

WALNUT SEAGRASS



NUTMEG SEAGRASS



TAN VINYL

Recommended for Gray Interior Upholstery



SEAGRASS GRAY



SLATE SEAGRASS



GRAY VINYL

COLOR OPTIONS

Powder-coated
Fence Rails



CHAMPAGNE



SILVER



BLACK

Fence Panel



CHAMPAGNE



SILVER



BLACK



RED



BLUE



BURGUNDY



WHITE



CHARCOAL

Interior
Upholstery



TAN



GRAY

**POPULAR
OPTIONS**



ALUMINUM
SKI TOW BAR



POWER ARM ELECTRIC
BIMINI



HIGHBACK CHAIR



FLIP UP CLEATS
(BENTLEY ONLY, STD ELITE)



BLACK-OUT PACKAGE



FURNITURE COVER



LOUNGE END FLIP UP
TABLE



LIFTING STRAKES



PERFORMANCE LIFTING
STRAKES



SKI LOCKER STORAGE



ALUMINUM UNDERSKIN



ACCENT DECALS



BLACK
ANODIZED RAILS



CLEAR ANODIZED RAILS
WITH BURG ACCENT
DECAL



BLACK BIMINI FRAME



RAISED HELM
PLATFORM



SIMRAD GO7 XSR
(BENTLEY ONLY, STD ELITE)



WIND SHIELD



HARDWOOD STEERING
WHEEL



EXTERIOR BLUE LED
LIGHTS



PLAYPEN COVER



PRIVACY CURTAIN



DROP DOWN
PRIVACY CURTAIN



BENTLEY CONSOLE-GRAY
WITH HUMMINBIRD HELIX 5



ROCKFORD STEREO SYSTEM
(BENTLEY ONLY, STD ELITE)



WET SOUNDS PREMIUM
SOUND SYSTEM PACKAGE



REAR RADIO REMOTE



SS TELESCOPING LADDER
(BENTLEY ONLY, STD ELITE)



FENDER PROS



DOUBLE BIMINI-BLACK
FRAME

The Bentley Pontoon Warranty

The team at Bentley pontoons goes to great lengths to search out quality vendors who collaborate and work with us to assist in the creation of our boats. Because of this, we offer strong warranties on our decking, workmanship, and components for all our pontoon boats. For added peace of mind, we've included our warranty details in the QR code that you can scan.

Our warranties include:

- Limited Lifetime Structural Warranty
- Limited Lifetime Workmanship Warranty on Tubes
- 5-year Limited Furniture Vinyl and Floor Covering Warranty
- 5-year Limited Bimini and Mooring cover fabric
- 5-year Limited Component Parts Warranty
- One-Time Warranty transfer

These warranties are benefits for the current and resale value. limitations, and required maintenance and care.

SCAN THE FOLLOWING QR CODE FOR THE ENTIRE
BENTLEY PONTOONS LIMITED WARRANTY



* OPTIONS ARE SUBJECT TO CHANGE WITHOUT NOTICE.



1650 Two Notch Road
Lexington, SC 29073



BentleyPontoons.com

www.facebook.com/bentleypontoons



[@bentleypontoons](https://www.instagram.com/bentleypontoons)

