

Class C Motorhome | 2018



Generations of family fun.



Seneca



Generations of family fun.

HANDS DOWN, THE BEST RIDE.

2
YEAR
LIMITED
WARRANTY



Our Wings Get You There

Family fun happens when you spread your wings. Thanks to Jayco's amenity-packed floorplans, rock-solid construction and two full camping seasons, or 24,000 miles, of warranty coverage, you can. Greater peace of mind and added comfort mean better memories and lasting bonds. So go ahead. Hit the road—and let the good times fly.

Generations of Family Fun



A FOUNDATION BUILT TO DELIVER FOR THE LONG HAUL

1. **Freightliner® S2RV chassis**
2. **Cummins® ISB 6.7L 360 HP diesel engine** features a 38,000-pound GCWR and a 29,000-pound GVWR; a 10,000-pound-rated hitch; and a gas-strut assisted hood for easy engine access
3. **Allison® 3000 MH automatic transmission** delivers power, control and traction
4. **100-gallon, single-fill, between-the-rails fuel tank**
5. **Michelin® 275/80R 22.5-inch tires**

SENECA™

TAKE TO THE ROAD AND LIVE WELL

Simply put, the 2018 Seneca is built to perform. Constructed on a world-class chassis along with unmatched ride and handling gear, styled with custom paint, and detailed with uninterrupted comfort and convenience in mind, this premium Class C motorhome elevates each adventure to a whole new level.

RIDE AND HANDLING. DEFINED.

JRide® Premium is a powerful blend of precise handling and renowned stability. Hands down, it's the best ride.

Experience JRide for yourself—visit your local dealer and take a test drive.

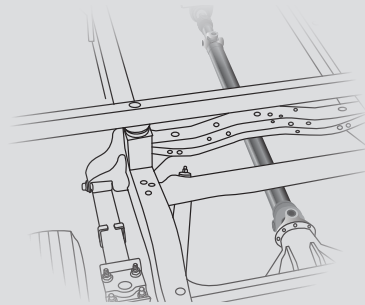

COMPUTER-BALANCED DRIVESHAFT

Ensures smooth and efficient power transfer to the wheels

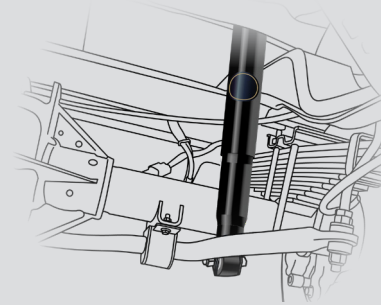

CUSTOM-TUNED SACHS SHOCKS

Resist heat and pressure while independently adjusting to changing road conditions for a smoother, more comfortable ride

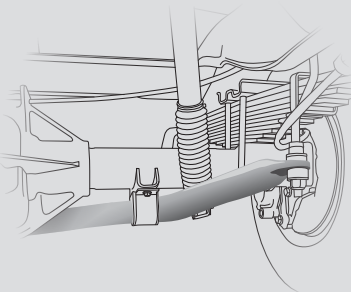

HEAVY-DUTY REAR STABILIZER BAR

A larger bar and polyurethane bushings, instead of rubber, transfer power faster for extra support, more stability and easier handling

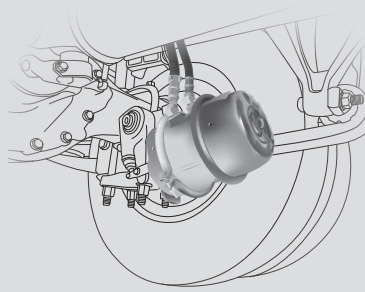

FULL AIR BRAKES

Offer peace of mind—even on the steepest inclines

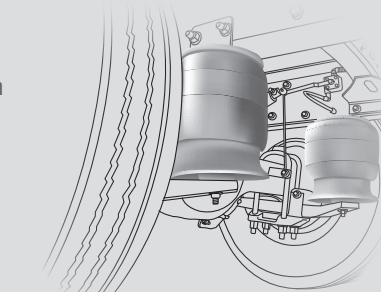

REAR AIR SUSPENSION

Improves stability under heavy loads



FEATURED FLOORPLAN: 37TS

SENECA

FEATURE KEY: 1. Pullout countertop extension 2. 750-pound-rated, full cab-over bunk 3. Solid-surface countertops 4. Soft-touch vinyl ceiling with recessed LED ceiling lights 5. Day/night roller shades 6. Flexsteel® furniture



37K EXPANDABLE SOFA



37TS HIDE-A-BED



37TS ALWAYS-ACCESSIBLE VANITY SEPARATE FROM BATHROOM



PASS-THROUGH BASEMENT STORAGE



TRUMA AQUAGO® ON-DEMAND WATER HEATER



37K BEDROOM WITH KING-SIZE BED



COCKPIT



NEW 37K ENTERTAINMENT CENTER

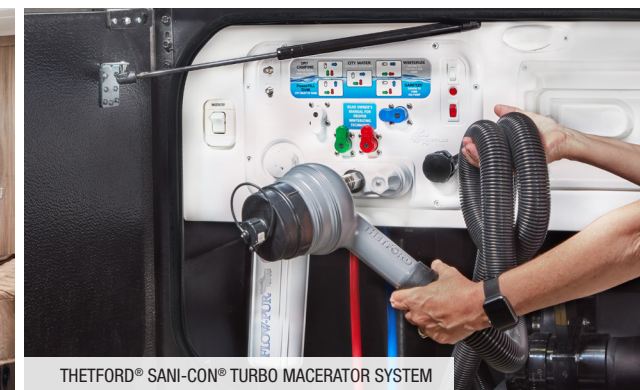

THETFORD® SANI-CON® TURBO MACERATOR SYSTEM

INTERIOR DÉCOR

CAMBRIDGE



SOFA/DINETTE

MAIN ACCENT

ACCENT

BEDSPREAD

BEDROOM ACCENT

PROVIDENCE



SOFA/DINETTE

MAIN ACCENT

ACCENT

BEDSPREAD

BEDROOM ACCENT

FLOORPLANS

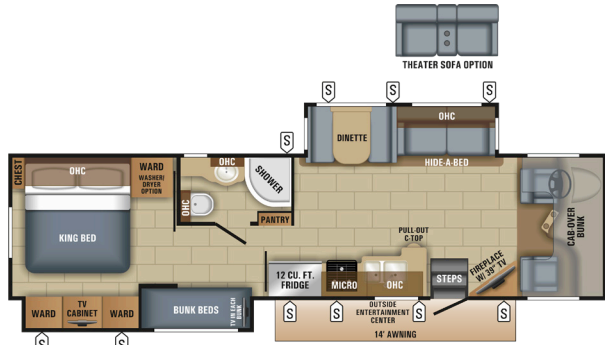

SENECA | 37FS

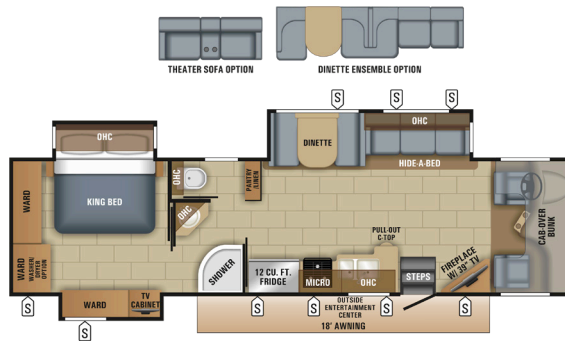

SENECA | 37HJ

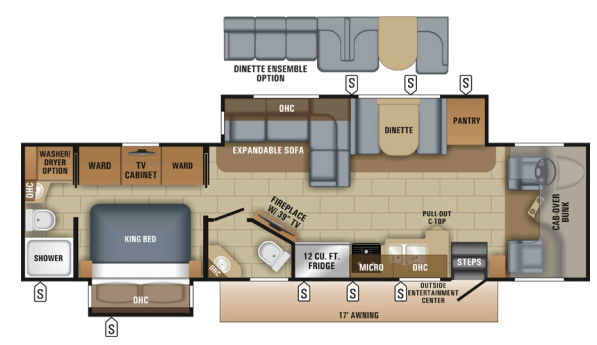

SENECA | 37K

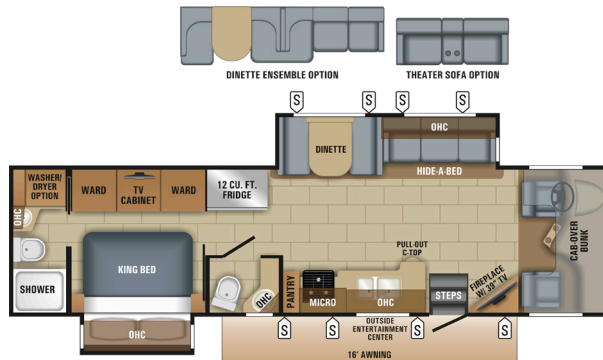

SENECA | 37RB

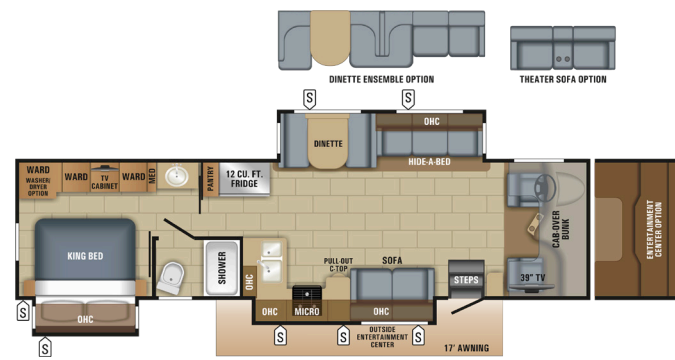

SENECA | 37TS

EXTERIOR SELECTIONS



Antique Ivory



Imperial Night



Sundial

SPECS

MODELS	DIMENSIONS					TANKS (GALS.)			
	FLOORPLAN	EXTERIOR LENGTH	EXTERIOR WIDTH	EXTERIOR HEIGHT (WITH A/C)	INTERIOR HEIGHT	WHEEL BASE	FRESH WATER CAPACITY	GREY WASTE WATER CAPACITY	BLACK WASTE WATER CAPACITY
37FS		38' 11"	101"	13' 1"	84"	279"	72	41	52
37HJ		38' 11"	101"	13' 1"	84"	279"	72	41	33
37K		39' 4"	101"	13' 1"	84"	279"	72	51 / 40	40 / 23
37RB		38' 6"	101"	13' 1"	84"	279"	72	41 / 40	33 / 23
37TS		38' 11"	101"	13' 1"	84"	279"	72	41	52

STANDARDS AND OPTIONS

CUSTOMER VALUE PACKAGE

JRide® Premium: Computer-balanced driveshaft, SACHS shock absorbers, heavy-duty rear stabilizer bar, full air brakes, rear air suspension

Jayco-exclusive Garmin® infotainment system powered by Fusion®

Backup and sideview cameras

Frameless windows

15,000-BTU A/Cs (2) with heat pumps

2,000-watt pure sine inverter

Electric power cord reel with 50-amp service

12V electric awning with LED lights

12-cubic-foot refrigerator with ice maker

Convection microwave

Truma AquaGo® on-demand water heater

STANDARD DRIVING EQUIPMENT

Freightliner® S2RV chassis

29,000-pound GVWR

38,000-pound GCWR

Cummins® ISB 6.7L 360 HP diesel engine

800 lb.-ft. torque

Allison® 3000 MH automatic transmission

10,000-pound-rated hitch with 7-pin plug

100-gallon fuel capacity

Dual chassis batteries

Alcoa® aluminum rims

Michelin® 275/80R 22.5-inch tires

Engine exhaust brake

Auxiliary start switch

Deluxe heated, remote-controlled, sideview mirrors

STANDARD EXTERIOR EQUIPMENT

High-gloss, gelcoat, vacuum-bonded, laminated sidewalls, floor and crowned roof

Deluxe full-body paint with Diamond Shield™

Bead-foam insulation (R-24 max roof, R-9 max floor and R-8 max walls)

One-piece seamless front cap

Fiberglass entrance door with oversized frameless window

Keyless entry, touchpad locking system

Electric-powered entrance steps

Slideout cover awnings

Dual-pane, tinted, safety-glass windows

Exterior entertainment center with AM/FM/CD/DVD player and 39-inch LED TV with speakers (2)

Onan® 8,000-watt Quiet Diesel™ generator with auto-gen start

Slideout battery tray (4 house batteries included)

56-pound propane tank

Black holding tank sprayer

Outside shower

Automatic hydraulic leveling jacks

Digital antenna with signal meter and powered amplifier

Thetford® Sani-Con® Turbo macerator system

LP quick-connect hookup

STANDARD INTERIOR EQUIPMENT

Soft-touch vinyl ceiling

Ball-bearing drawer guides

Deluxe hidden-hinge cabinetry

Solid-surface countertops with decorative backsplash

Water filtration system

Dream Dinette™ mechanism, raises/lowers tabletop

Seatbelts in all seating positions

Linoleum flooring

Systems monitor panel

High-intensity recessed LED ceiling lights

12V electrical system with 120V, 80-amp power converter

35,000-BTU auto-ignition furnace with digital wall thermostat

Blu-Ray™ with HDMI® connections to all televisions

Cable TV hookup with RG-6 coax and video selector switch

Residential medicine cabinet with mirror

Porcelain stool with foot pedal

One-piece fiberglass shower with glass shower door

Shower skylight with light

King-size bed with bedspread

32-inch LED HDTV in bedroom

Full cab-over bunk (750-pound rating)

Bunk beds (300-pound rating) (37FS)

OPTIONS

Premium Sikkens paint selections: Antique Ivory, Imperial Night, Sundial

Front entertainment center with LED TV (37TS)

Canadian Shaw® TRAV'LER® satellite dish

Winegard® TRAV'LER satellite dish - DIRECTV®

Dinette ensemble (n/a in 37FS)

Washer/dryer combo (37K, 37RB, 37TS)

Washer/dryer stackable (37FS, 37HJ)

Dinette booth with power theater seats (n/a in 37K)



GARMIN®
powered by **FUSION**



JAYCO-EXCLUSIVE GARMIN INFOTAINMENT SYSTEM POWERED BY FUSION

New for 2018 and exclusive to Jayco motorhomes, this easy-to-use, detachable touchscreen system delivers the convenience of connectivity, doubling as a custom RV navigation and four-zone AM/FM/Bluetooth®/USB entertainment system.

Gross Vehicle Weight Rating (GVWR): The maximum permissible weight of the motorhome, including the Unloaded Vehicle Weight (UUV) plus passengers, personal items, all cargo, fluids, options and dealer-installed accessories. The GVWR is equal to or greater than the sum of the UUV and the Cargo Carrying Capacity.

Gross Combined Weight Rating (GCWR): The maximum allowable combined weight of the motorhome used as a tow vehicle and the attached towed vehicle.

It is important for your safety and enjoyment that you are aware of the weights and tow ratings of the RV you select. Consult a competent advisor for questions or advice. Whether you are new to RVing or a veteran, get a feel for the performance of your RV before heading out on the roadways. When you tow a vehicle with your RV, you must drive differently than when you drive a single vehicle. Practice hooking up, driving, backing up and braking in a safe environment or seek out professional instruction. Jayco affixes a weight label to each RV which lists weight information for that vehicle. Refer to that label to verify the vehicle will meet your requirements.



1. **One-piece seamless fiberglass front cap** for increased durability and ultimate weather protection
2. **750-pound overhead bunk capacity** offers nearly 250 pounds more than the industry average for greater safety and peace of mind
3. **Premium Sikkens paint** gives you a superior, more durable finish
4. **50-amp service and auto-generator start** offer an enhanced electrical system for the best in comfort and remote cooling when needed
5. **Seatbelts in every seating position** secure the most precious cargo
6. **Fiberglass running boards**
7. **Dual-pane, tinted and frameless safety-glass windows**
8. **Fiberglass entrance door** with oversized frameless window



Generations of family fun.

Meet your Jayco Dealer

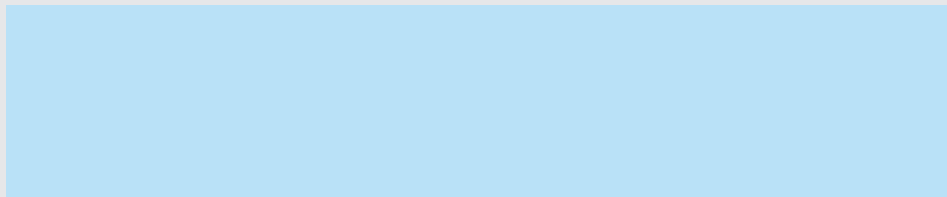

We work hard—so you can play hard. From finding the perfect Jayco for your family to providing flexible financing options and full-service support, we're here to help.

Follow Jayco



Jayco, Inc. | P.O. Box 460 | Middlebury, IN 46540 © RVIA

See dealer for further information and prices. All information in this brochure and on www.jayco.com is the latest available at the time of publication approval. Jayco reserves the right to make changes and to discontinue models without notice or obligation. Photography may show optional equipment or props used for decoration purposes only. RVs built for sale in Canada may differ to conform to Canadian codes. JAYCO and the JAYCO BIRD IN FLIGHT are registered trademarks of Jayco, Inc. Printed in USA 25K 11/17 ©2017 Jayco, Inc. 274784

Travel with Confidence

2
YEAR
WARRANTY

At Jayco, we build our RVs to handle every adventure, then back them with our industry-leading 2-year limited warranty. We, with support from our select partners, have you covered for **2 camping seasons** or **twenty-four thousand (24,000) miles** (mileage limitation applies to motorized products only), whichever occurs first, from the original date of purchase. You won't find a better warranty in the business, because the only strings we attach are those that deliver the ultimate in reliability. That's the Jayco difference. So go explore. For a copy of our 2-year limited warranty with complete terms and conditions, please contact your local Jayco dealer.

FREE
ROADSIDE
ASSISTANCE

A year's access to Coach-Net™—the country's largest RV emergency road service.



eco advantage™

Jayco's long-term commitment to generations of family fun

After six years of increased efforts to eliminate waste, conserve energy and increase recycling, we've come a long way in building RVs that are not only better for your family—but also better for the planet.

Learn more at Jayco.com/EcoAdvantage