

2017 VESTA

2017 VESTA

CLASS C GAS



HOLIDAY RAMBLER®

This is living.

VESTA

TOP FEATURES

EXTERIOR

- Aluminum Square Luggage Doors
- Exterior Wall-Mounted Entertainment Center
- Color Monitor for Side and Rear Cameras
- Dynamic Ride Suspension
- Roof-Mounted Integrated Awnings

INTERIOR

- 11 cu. ft. Two-Door Whirlpool Stainless-Steel Residential Refrigerator
- Stainless-Steel Microwave
- Solid-Surface Countertops
- Energy-Efficient, Flush-Mount LED/Ceiling Lights Throughout



The Vesta 31U is shown in Chocolate Truffle décor with Glazed Italian Sienna cabinetry.

This is living.

At Holiday Rambler, your dream journey is our unwavering inspiration. Whether you're planning a rambling weekend getaway or imagining a cross-country holiday adventure, we know that owning a motorhome is a dream lifestyle. We take that dream seriously. **We focus on the idea of home — not the place, but the feeling.** Then we make sure to turn that feeling into one of the most envious getaways. Holiday Rambler. This is living ...





2017 VESTA

Don't settle for the expected. Instead, experience life to the fullest. For 2017, Holiday Rambler is introducing the all-new Vesta, a Class C motorhome that breaks the mold in RV living. The breathtaking Vesta sets the bar in the kitchen alone, featuring solid-surface countertops, high-gloss cabinetry and stainless-steel appliances, including a residential Whirlpool refrigerator. Get ready to reimagine Class C motorhome living.

Choose life's finer details.



INTERIOR THROUGHOUT

- (1) 15,000 BTU Ducted Air Conditioner w/Heat Pump
- 6 Gallon Propane/120V Water Heater w/Electronic Ignition
- 30,000 Btu/h Single Furnace (31U)
- Child Tether Seating Position
- 1200W Inverter
- Deluxe Padded Ceiling
- Dual 20,000 BTU Furnaces (30D)
- Energy Efficient LED Flush Mount Ceiling Lighting Throughout
- Full Extension Drawers
- Hardwood, High Gloss Raised Panel Cabinet Doors/Drawers Upper & Lower
- Hardwood Slide-out Fascia
- Hidden Cabinet Door Hinges
- Night Roller Shades Throughout
- Soft Touch Sofa & Dinette Seating
- Whole Coach Water Filtration System

OPTIONS

- CSA Package

DRIVER CONVENIENCE

- 12V & USB Accessory Ports
- 3 Point Seat Belts at Driver and Front Passenger Seats
- AM/FM Radio w/CD Player
- Auxiliary Emergency Start Assist Switch on Dash
- Cab Carpet
- Cup Holders - 2 Holders in Dash
- Dash Air Conditioning
- Driver & Passenger Sun Visors
- Electronic Cruise Control
- Front Cab Closeout Fabric Curtain
- Front Cab Dome Light
- Power Driver & Passenger Windows & Locks
- Power Remote/Heated Mirrors w/Side View Camera
- Reclining Driver & Passenger w/Soft Touch Seats
- Safety Air Bags Driver & Passenger
- Tilt Steering Column
- Windshield Wipers w/Delay

OPTIONS

- Satellite Radio

LIVING ROOM

- 40" Flat Screen LED TV
- Soft Touch Dinette w/Child Tether
- Soft Touch Jack-knife Sofa
- Front Cab Hardwood Overhead w/Entertainment System & Cabinets

OPTIONS

- Front Cab Hardwood Overhead w/Entertainment System & Cabinets

GALLEY

- 11 cu.ft. Two-Door Stainless Steel Residential Refrigerator
- 3 Burner Cooktop w/Glass Cover
- Deep Double Bowl Under Mount Stainless Sink
- Full Length Roller Bearing Drawer Guides
- Indirect Under Cabinet Lighting
- Night Roller Shade
- Power Vent
- Residential Single Handle
- Faucet w/Pullout Sprayer
- Tile Backsplash
- Solid Surface Galley Countertop
- Solid Surface Sink Covers
- Stainless Steel Convection Microwave

OPTIONS

- 3 Burner Range w/Oven
- Dometic 8 cu. ft. Two-Door Refrigerator w/Ice-maker

BEDROOM

- 28" x 76" x 5" Bunk Bed Mattress (30D)
- 32" LED TV
- Bunk Bed Bedspreads and Privacy Curtains (30D)
- Designer Bedspread & Pillow Shams
- DVD Player
- Lift Up Bed with Under Bed Storage
- Queen Size Mattress
- Solid Surface Nightstand Tops
- Under Cabinet Reading Lights

OPTIONS

- Dual Flat Panel TVs Bunkbeds (30D)

BATHROOM

- Medicine Cabinet w/ Mirror
- Porcelain Foot-flush Toilet
- Power Vent
- Premium Vinyl Flooring
- Residential Brushed Nickel Faucet
- Shower Head w/On/Off and Matching Dual Valve Faucet
- Shower Skylight
- Solid Surface Countertop

STANDARDS AND OPTIONS



EXTERIOR THROUGHOUT

- 14 Gallon LP Tank
- Acrylic Lighted Grab Handle at Entry Door
- Aluminum Square Baggage Doors
- Batteries: (2) 6V Deep Cycle House Batteries
- Black Water Tank Flush
- Chrome Front Bumper
- Color Match Exterior w/Premium Graphics
- Dark Tinted Frameless Windows Throughout
- Daytime Running Lights
- Debris Awning Above All Slide-Out Rooms
- Exterior Lighted Power Entry Step
- Exterior Park Cable & Hookup
- Exterior Shower
- Front and Rear LED Clearance Lighting
- GFCI Receptacle
- Hitch - Capacity of 7,500# w/7-Way Round Tow Connection
- Patio lights - (One door side, One passenger side over service bay)
- Onan® 4.0kW MicroQuiet Generator
- Prep for Roof Mount Satellite Dish
- Propane Quick Connect
- Rear Ladder
- Remote Power/Heated Mirrors w/Side View Cameras
- Running Boards
- Roof Mounted Integrated Box Patio Awning w/ LED Lighting
- Solar Electrical Panel Prep
- Unidirectional Antenna
- Wall Mounted Exterior Entertainment Center w/32" LED TV, AM/FM/CD/DVD Radio, & 2 Speakers

OPTIONS

- Frameless Dual Pane Windows
- Full Body Paint Exterior
- King Dome Satellite
- Roof Rain Vent Covers



SAFETY/CONVENIENCE

- 10 lb. ABC Fire Extinguisher
- 30 Amp Electrical Service & 30' Power Cord
- 1200W Inverter
- Automotive Safety Glass
- Battery Access Entry Step Cover
- Battery Disconnect
- Carbon Monoxide Detector/Alarm
- Egress Window
- Entry Door w/Screen Door & Deadbolt Lock
- Exterior & Interior Entry Assist Handle
- GFI Circuit Protection
- High Mounted Large Taillights
- Multiple Seatbelt Locations
- Porch Light w/Interior Switch
- Propane Detector/Alarm
- Power Electric Step
- Smoke Detector/Alarm
- Automatic Hydraulic Leveling Jacks



STORAGE

- Molded Cross Link Polyethylene
- Battery Compartment w/Lid
- Pass Through Storage
- Rotocast Molded Storage Boxes
- Slam Latch Luggage Doors

BODY STRUCTURE

- 26" Wide Radius Corner Entry Door w/Obscured Window
- Corrosion Resistant Aluminum Tube Hull Framing
- Full Basement Exterior
- Heated Fresh Water & Holding Tank Compartments
- Molded Rear Wheel Trim Flares
- One-Piece Molded Fiberglass Front End Cap
- Pass Through Storage
- Powder Coated, Steel Running Boards
- Radius Roof
- Sidewalls Framed with 1-1/2" Aluminum Tubing
- Steel Powder Coated Rear Bumper
- Vacu-bond® Floor
- Vacu-bond® Hull Lamination Process



THE SMOOTHEST CLASS C RIDE FEATURING REV CONTROL RYDE™

Our all-new Class C motorhome rides on the industry exclusive REV Control Ryde™ Suspension (RCR) system. Partnering with MORryde we use the rubber shackle 'airless' suspension system – the newest suspension system to the Class C market. The RCR Suspension system takes systems engineered for the ambulance and emergency vehicle industry to offer Class C owners a ride like no other. Owner's can skip airbag maintenance with the RCR system, which tackles the roughest roads with unique rubber shear springs that cushion the motorhome and absorbs road shock. We also offer the industry's only 'Anti-dive' technology which brings superior control during braking through reduced front end dive.

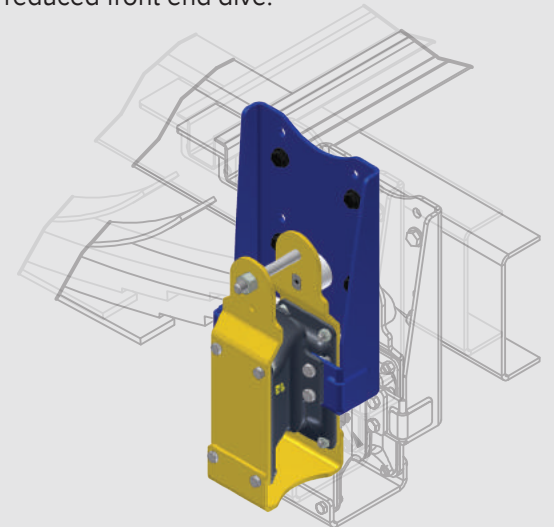

AUTOMOTIVE

- 4-Point Automatic Levelers
- Trailer Hitch w/7-Pin Electrical Hook Up

Choose life's finer details.

FLOORPLANS

30D

Options: 113, 146, 157, 351, 860/864

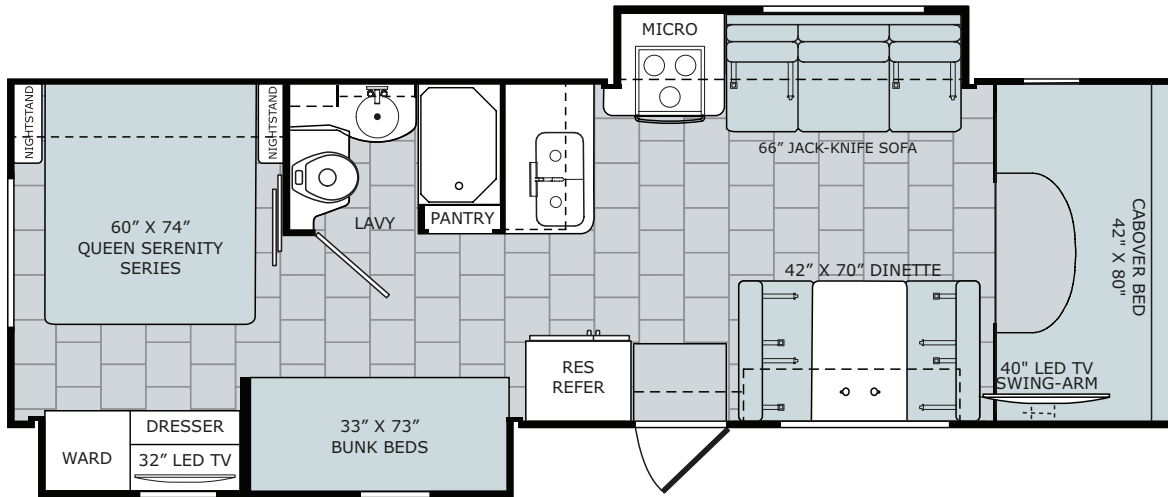

Available Options



OPT. 113
3-BURNER
COOKTOP
W/OVEN

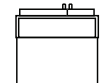

OPT. 146
2-DOOR REFRIG
W/ICEMAKER



OPT. 351
40" LED TV
W/HOME
THEATER SYSTEM

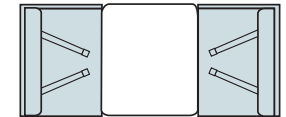

OPT. 860/864
DINETTE W/ SWING DOWN BUNK
30" X 70" DINETTE / 28" X 70" BUNK

31U

Options: 113, 146, 351

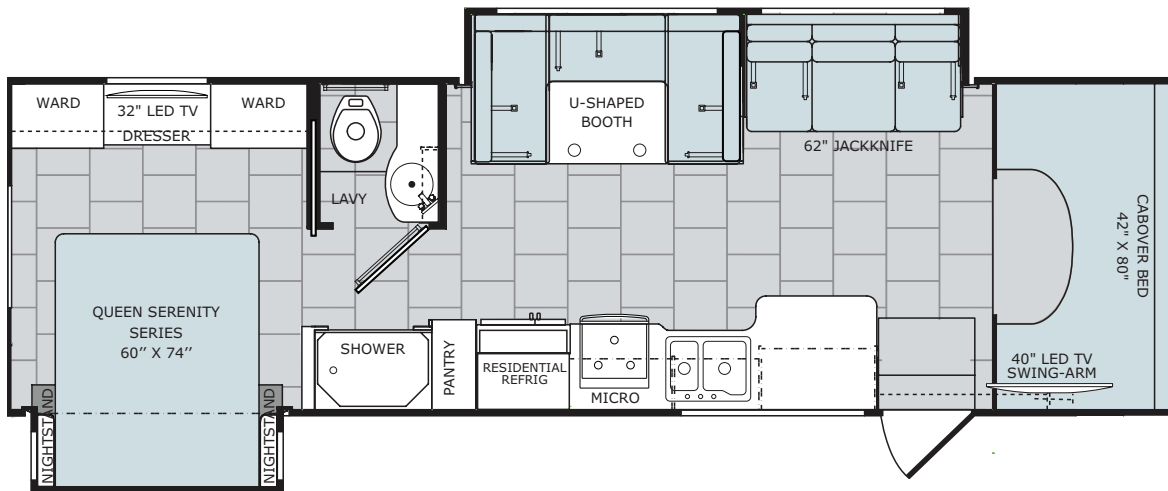

Argent Sand



Option 507: Full Body Paint Exterior

Garnet Streak



Option 506: Full Body Paint Exterior

WOOD CHOICES

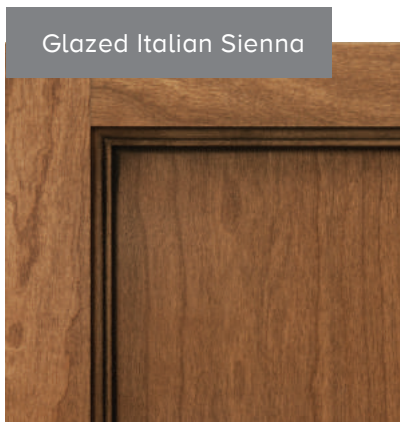
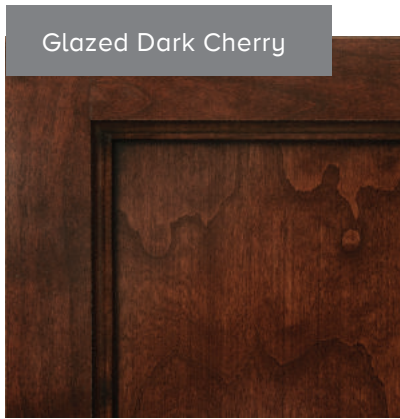

DÉCOR CHOICES



1 | Sofa 2 | Accent 3 | Bedspread 4 | Countertop 5 | Flooring 6 | Carpet

EXTERIOR CHOICES



CHASSIS

MODEL	30D	31U
Wheelbase	214"	214"
GVWR (lbs) ¹	14,500	14,500
Front GAWR (lbs) ²	5,000	5,000
Rear GAWR (lbs) ²	9,600	9,600
GCWR (lbs) ³	22,000	22,000
Hitch Rating Weight (lbs) [†]	7,500	7,500
Tongue Weight (lbs)	500	500
Fuel Capacity (gal)	55	55

FORD® CHASSIS

Model: Ford
 Engine: 6.8L Triton V10
 Transmission: Ford 6-Speed, Automatic w/Overdrive

Alternator: 155 Amp
 Torque: 420 lb.-ft. @ 3250 RPM
 Horsepower: 305 HP

DIMENSIONS AND CAPACITIES

MODEL	30D	31U
Overall Length ⁴	31' 8.5"	32' 5.5"
Overall Height (suspension inflated) ^{5,6}	12'	12'
Overall Width (suspension inflated) ^{5,6}	102"	102"
Interior Height (maximum)	82"	82"
Interior Width (maximum)	96"	96"
Patio Awning Width	16' 4"	16' 4"
Interior Storage (cu. ft.)	110	115
Exterior Storage (cu. ft.)	104	90
Fresh Water Holding Tank (gal)	60	49
Grey Water Holding Tank (gal)	35	35
Black Water Holding Tank (gal)	35	35
Appliance Propane Tank (gal) (WC) ⁷	14	14
Water Heater Tank (gal)	6	6



HOLIDAY RAMBLER®

This is living.

YOUR LOCAL DEALER

DISCLAIMER

- GVWR (Gross Vehicle Weight Rating) is the maximum permissible weight of this fully loaded motorhome. The GVWR is equal to or greater than the sum of the (UVW) unloaded vehicle weight plus the (OCCC) occupant cargo-carrying capacity*.
 - GAWR (Gross Axle Weight Rating) is the maximum permissible loaded weight a specific axle is designed to carry.
 - GCWR (Gross Combined Weight Rating) is the value specified by the motorhome manufacturer as the maximum allowable loaded weight of this motorhome with its towed vehicle. Towing and braking capacities may be different. Refer to Holiday Rambler and chassis manufacturer's manuals for complete information.
 - Length measured from front bumper to rear bumper (excludes accessories).
 - Excludes safety equipment and awnings.
 - Motorhomes feature a body width over 96" which will restrict your access to certain roads. Before purchasing, you should research any state and/or province road laws which may affect your usage.
 - Tank manufacturer's listed water capacity (WC). Actual propane capacity is 80% of water listing as required by the safety code.
- * The chassis manufacturer recommends the installation of a supplemental brake control system to activate the brakes on the vehicle or trailer you are towing. Hitch receiver ratings expressed are maximum for the hitch receiver installed and may require the purchase of additional equipment that is dependent on the weight of the towed load. Consult with hitch receiver manufacturer for further information.
- * UVW and OCCC are found on the label containing the federal certification tag in each RV.
- ** The Minimum Towable Load of this vehicle is the available weight capacity, up to GCWR, when the coach is fully loaded to maximum GVWR. However, if the coach is loaded to something less than maximum GVWR, that extra available weight capacity can be added to your Towable Load. For example, if your coach is loaded to 1000lbs less than maximum GVWR, your Towable Load increases accordingly. Do not exceed the hitch rating weight, GVWR or GCWR.
- ** All 2017 REV Recreation Group motorhomes include a limited one-year/15,000-mile coach warranty and three-year/45,000-mile structural warranty, whichever occurs first, and is fully transferable for the first 12 months.

CONTACT US

To locate a dealer near you, visit our website at www.holidayrambler.com or call 1-877-252-4666. We can also be contacted at Holiday Rambler Customer Relations, P.O. Box 1007, Decatur, IN 46733.

IMPORTANT—PLEASE READ

Product information, photography and illustrations included in this publication were as accurate as possible at the time of printing. For further product information and changes, please visit our website at www.holidayrambler.com or contact your local Holiday Rambler dealer. Prices, materials, design and specifications are subject to change without notice. All weights, fuel, liquid capacities and dimensions are approximate. Holiday Rambler has designed its recreational vehicles to provide a variety of uses for customers. Each vehicle features optimal seating, sleeping, storage and fluid capacities. The user is responsible for selecting the proper combination of loads (i.e., occupants, equipment, fluids, cargo, etc.) to ensure that the vehicle's capacities are not exceeded.



Holiday Rambler is part of REV Recreation Group, a division of REV Group, Inc., a family of 26 industry-leading motor vehicle brands. At REV Group, we innovate, design and build products that connect and protect thousands of people every day—our trusted vehicles are engineered with the utmost rigor and precision to deliver the highest levels of performance, reliability, durability and safety.

www.holidayrambler.com

©2016 REV Group, Inc. Printed in the USA. Inventory Control Number VESTA17B1, 08/16. Model Year 2017, First Edition.