



CARBON

FIFTH WHEEL TOY HAULERS • TRAVEL TRAILER TOY HAULERS



KEYSTONE
RV COMPANY

CAMP BETTER

ENJOY YOUR INDEPENDENCE

If sitting on the couch isn't exactly your cup of tea, Keystone Carbon fifth wheel toy haulers may be your ticket to an endless supply of weekend exploration. With features like frame-welded tie downs, Omni-Chill™ high-efficiency A/C systems, and SolarFlex™ solar energy packages, seeing the world has never been easier.

A Fresh Take

Carbon is offering a choice of two decors for 2022, Carbide and Axis. Both decors feature a combination of Scandinavian and modern elements with their light Ashby Maple woodgrains, Designer White cabinetry, and black hardware accents.

Décor Options

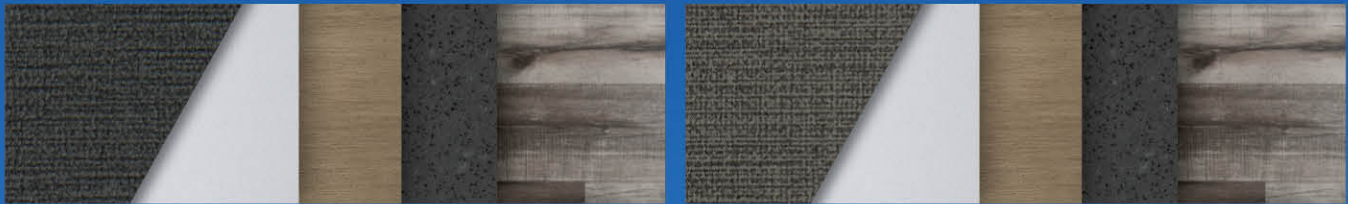

CARBIDE

AXIS

Rugged Construction

- Frame-welded tie downs
- Alphaflex one-piece TPO walkable roof w/ aluminum flashing
- Dyna Span® floor decking Dexter 7,000 lb axles with electric self-adjusting brakes
- Heated and enclosed underbelly

Unexpected Convenience

- 6 point hydraulic level-up
- Omni-Chill™ A/C system
- HitchVision™
- Carpet-free bedroom
- Extra tall entry doors (78")



Wireless Charging

Quickly and conveniently transfer power to your device without clunky cables.

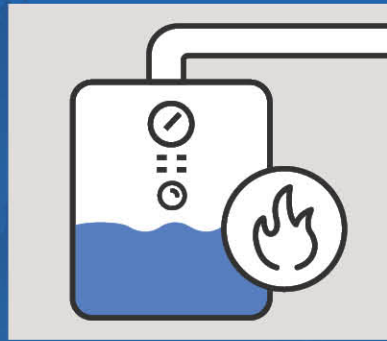

On-Demand Water Heater

Endless hot water when you need it most. (FW's only)



Soft-close Hardwood Cabinetry

Sturdier construction and quiet closure for undetected midnight snacking.

SCAN HERE TO
LEARN MORE



VISIT [KEYSTONERV.COM/CARBON](https://www.keystonerv.com/carbon) FOR IN-DEPTH PRODUCT INFORMATION, VIDEOS, MODEL 360'S AND MORE.

FIFTH WHEELS | CARBON TOY HAULER FLOORPLANS

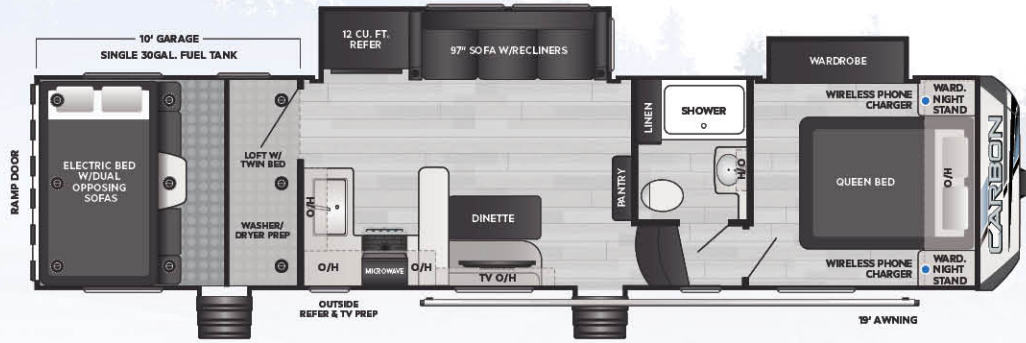

338

Tandem axle, 10' garage, dinette seating

WEIGHT 12096 LENGTH 35' 11"

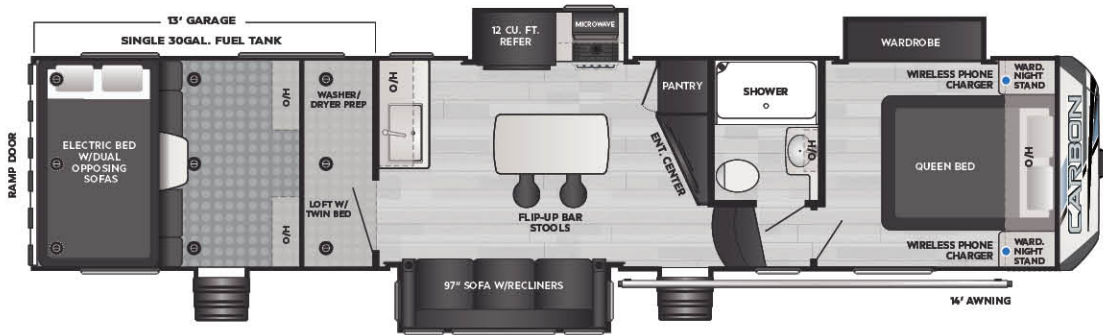

348

Tandem axle, 13' garage, island w/ seating

WEIGHT 12691 LENGTH 38' 11"

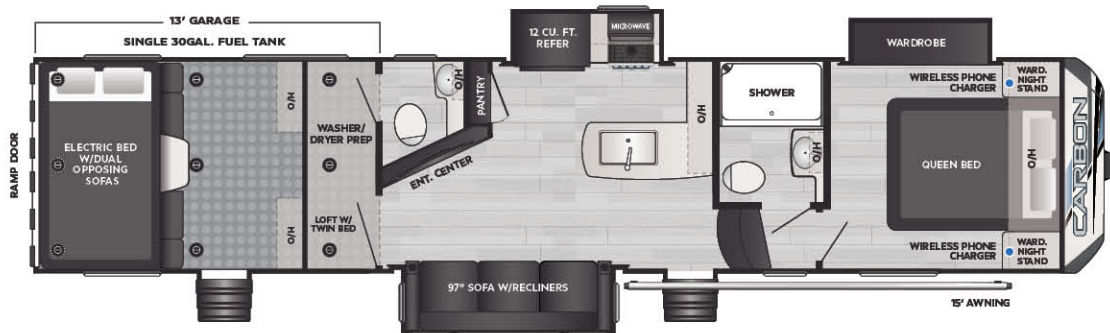

358

Tandem axle, 13' garage, 1 1/2 bath

WEIGHT 12742 LENGTH 38' 11"

FIFTH WHEELS | CARBON TOY HAULER FLOORPLANS

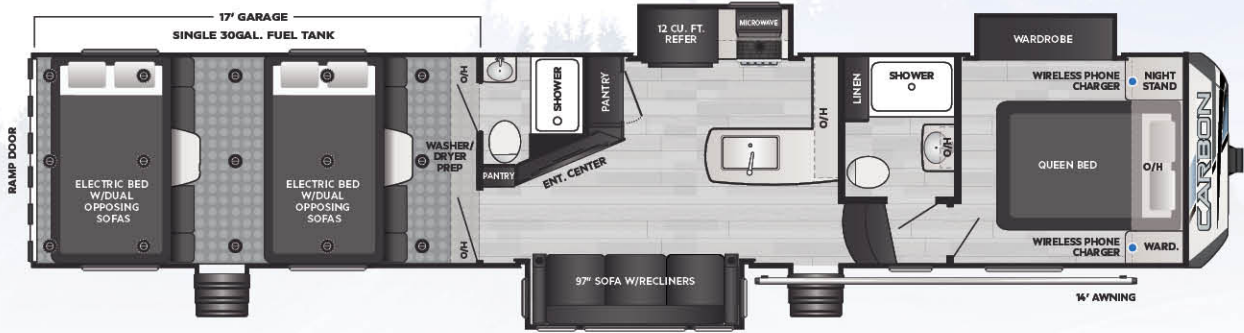

NEW!
398

Triple axle, 17' garage w/ dual electric beds, 2nd full bath
WEIGHT 14130 LENGTH 43' 11"

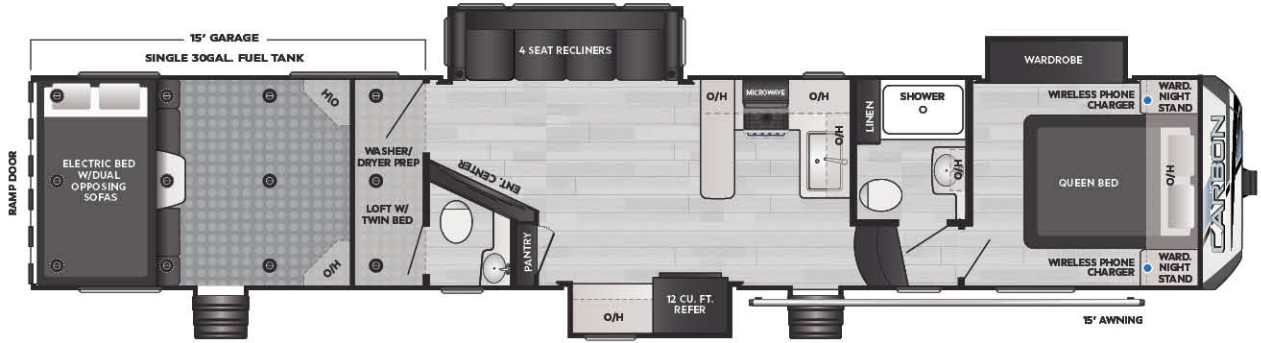

418

Triple axle, 15' garage, u-shaped kitchen
WEIGHT 14152 LENGTH 44' 6"



VISIT KEYSTONERY.COM/CARBON FOR IN-DEPTH PRODUCT INFORMATION, VIDEOS, MODEL 360'S AND MORE.

TRAVEL TRAILERS | CARBON TOY HAULER FLOORPLANS

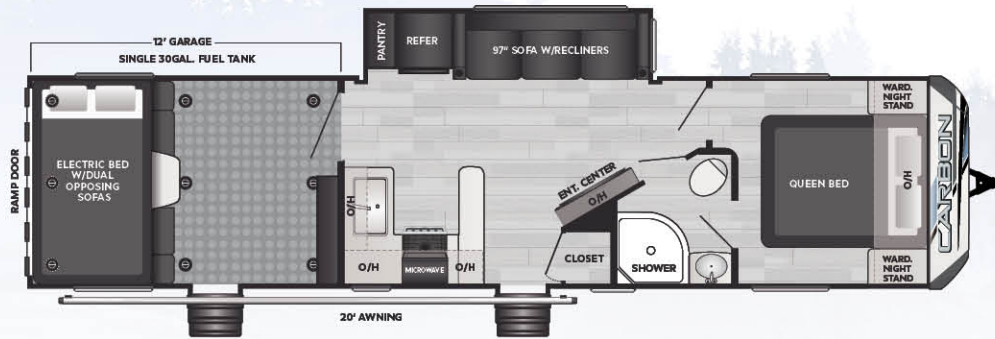

35

Tandem axle, 12' garage, u-shaped kitchen

WEIGHT 9815 LENGTH 38' 6"

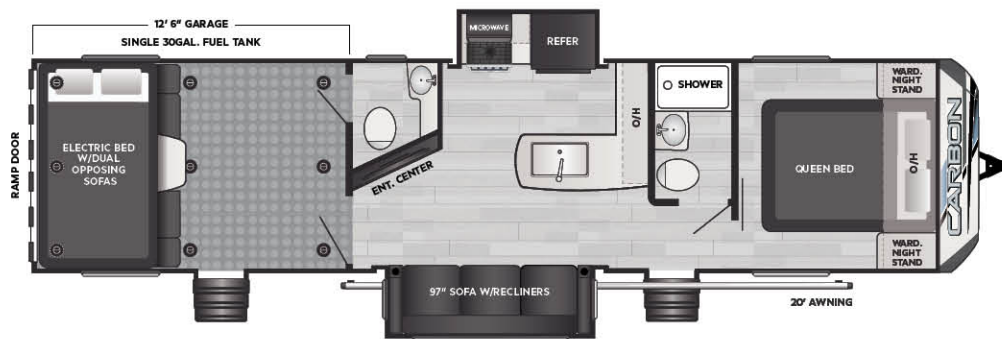

36

Tandem axle, 12' 6" garage, L-shaped kitchen

WEIGHT 10176 LENGTH 38' 0"

CARBON | MODEL SPECIFICATIONS

MODEL	WEIGHT	CARRYING CAPACITY	HITCH WEIGHT	FRESH WATER	WASTE WATER	GRAY WATER	LPG	LENGTH*	WIDTH	HEIGHT	AWNING
35	9815	3185	1535	94	38	76	60	38' 6"	8' 4"	12' 4"	20'
36	10176	2824	1720	94	76	38	60	38' 0"	8' 4"	12' 4"	20'
338	12096	4724	2820	94	44	82	60	35' 11"	8' 4"	13' 2"	19'
348	12691	4309	3130	94	44	82	60	38' 11"	8' 4"	13' 2"	14'
358	12742	4258	3175	94	82	44	60	38' 11"	8' 4"	13' 2"	14'
398	14130	4870	3780	94	82	82	60	43' 11"	8' 4"	13' 6"	14'
418	14152	4848	3525	94	82	82	60	44' 6"	8' 4"	13' 6"	15'

DISCLAIMER: Product information is as accurate as possible as of the date of publication of this brochure. All features, floor plans, and specifications in this brochure are subject to change without notice. Please also consult Keystone's web site at www.keystonerv.com for more current product information and specifications. Tow Vehicle Disclaimer. CAUTION: Owners of Keystone recreational vehicles are solely responsible for the selection and proper use of tow vehicles. All customers should consult with a motor vehicle manufacturer or their dealer concerning the purchase and use of suitable tow vehicles for Keystone products. Keystone disclaims any liability or damages suffered as a result of the selection, operation, use or misuse of a tow vehicle. KEYSTONE'S LIMITED WARRANTY DOES NOT COVER DAMAGE TO THE RECREATIONAL VEHICLE OR THE TOW VEHICLE AS A RESULT OF THE SELECTION, OPERATION, USE OR MISUSE OF THE TOW VEHICLE. *Length is defined as the distance from the centerline of hitch pin/coupler to rear bumper of trailer. Please review owner's manual prior to purchase for more information on service warranties, extended use, towing and maintenance. Owner's manuals can be found at keystonerv.com.

LAUNCHING AS STANDARD EQUIPMENT ON ALL KEYSTONE
TRAVEL TRAILERS AND FIFTH WHEELS, FALL 2021

SOLAR
FLEX

**TAKE CHARGE
OF HOW
YOU CAMP**

The Solar Energy System You've Been Waiting For

Impossibly versatile, exceptionally designed, SolarFlex is shattering customers' expectations of factory-installed solar power. SolarFlex eliminates the guesswork to deliver affordable, high quality solar energy systems.

Carbon offers SolarFlex 200 as standard, with the option to upgrade to SolarFlex 400i or SolarFlex 600i-L.



Learn more about the
SolarFlex difference and
packages now available.

PRINT 9.2021



KEYSTONE
RV COMPANY

CAMP BETTER