

2005 JAY FEATHER™ ULTRA LITE WEIGHT TRAVEL TRAILERS BY JAYCO



It's hard to see your worries from this side of the mountain.





2005 Jay Feather<sup>®</sup> EXP

Find the simplest way  
to take it easy.



*Pack the bedroom wardrobe's lightweight plastic tub drawers anywhere and slide them in when ready to travel. Pack more into our exclusive MaxiStor<sup>™</sup> system, with a huge outer door and room beneath a rear bunk.*



Everyday life is a struggle against deadlines, appointments and constant demands of your time. But once you see fields of swaying grain, forests of fluttering leaves and skies that stretch forever, your mind clears and you feel those struggles lose their grip. Find an easy way to get there in Jay Feather<sup>™</sup>

EXP Ultra Lite Weight travel trailers. They expand your sleeping space with fold-down beds and make towing a breeze behind your minivan or SUV. Your only struggle will be leaving your campsite.

**For more information go to [www.jayco.com](http://www.jayco.com)**

*Jay Feather<sup>™</sup> EXP's lightweight construction makes towing easy.*



*Our exclusive hidden bunk cable support system eliminates support poles to make setting up quicker and easier.*

*Deep quilted bunk cushions provide extra comfort. Optional heated bed mats keep you comfortable even on chilly nights.*



**18 F EXP interior**



*Get consistent-tasting drinking water with the optional water purifier.*





*Attractive, matching bunk privacy curtains give you a little time to yourself.*

*Pack longer items in the front pass-through storage compartment.*

*The kitchen features beautiful cabinets with Westview maple doors, traditional, strong mortise-and-tenon joints and screwed stile construction. An oven and microwave oven are part of the Jay Feather™ EXP Customer Value Package.*



*Store plenty of food in the large pantry.*



18 F EXP kitchen



2005 Jay Feather™ LGT

# Clear your schedule ... and your mind.

Fishing at sunrise. Grilled perch at noon. A nap before supper. Your day is too full to fit in stress and headaches. That's why Jayco® makes Jay Feather™ LGT Ultra Lite Weight travel trailers ultra easy to tow. They're 10 to 15% lighter

than conventional travel trailers of similar length, so you won't have to fight to reach your favorite scenic setting. But you'll get the same roomy interior and ample cargo space — including pass-through storage — for all your stuff. Finding peace of mind has never been this easy.



26 S LGT interior



*The bathroom gives you everything you need, such as a medicine cabinet with mirror and 12V vent fan — all standard.*





# 2005 Jay Feather<sup>™</sup> LGT



*Gain more floor space with the J-Steel<sup>™</sup> sofa slideout (select models). The easy-to-use electric power slideout comes standard.*

*Fit all your favorite clothes in the bathroom wardrobe (select models).*



*Jay Feather<sup>™</sup> LGT's lightweight design, smooth aerodynamics and independent torsion-axle rubber ride suspension system make it easy to tow.*

*Your music goes anywhere with the optional AM/FM/CD stereo, part of the Jay Feather<sup>™</sup> LGT Customer Value Package.*





*Your menu will be limited only by your imagination. Cook on the 3-burner range top, or use the oven or microwave oven, both included in the Jay Feather™ LGT Customer Value Package.*

*Our optional portable gas RVQ® barbecue grill lets you cook outdoors. It easily mounts on the outside of the trailer and comes with a handy carrying case.*



*Jay Feather™ LGT gives you a walk-around queen bed (N/A 19 W). A standard bunk over double bed (select models) adds extra sleeping space. Store loads of stuff under the bed with the optional innerspring mattress (part of the Jay Feather™ LGT Customer Value Package) that lifts easily on struts.*





**Built to last and to create lasting memories.**

Frame is 10-15% lighter than the frame of conventional travel trailers.

E-Coat<sup>™</sup> automotive electronic paint process inhibits rust. Independently tested to withstand salt spray.

Aerodynamic design, lighter weight and standard enclosed underbelly (LGT) make towing easier and more efficient.

Tapered rail design strategically places the strongest part of the frame over the axles.

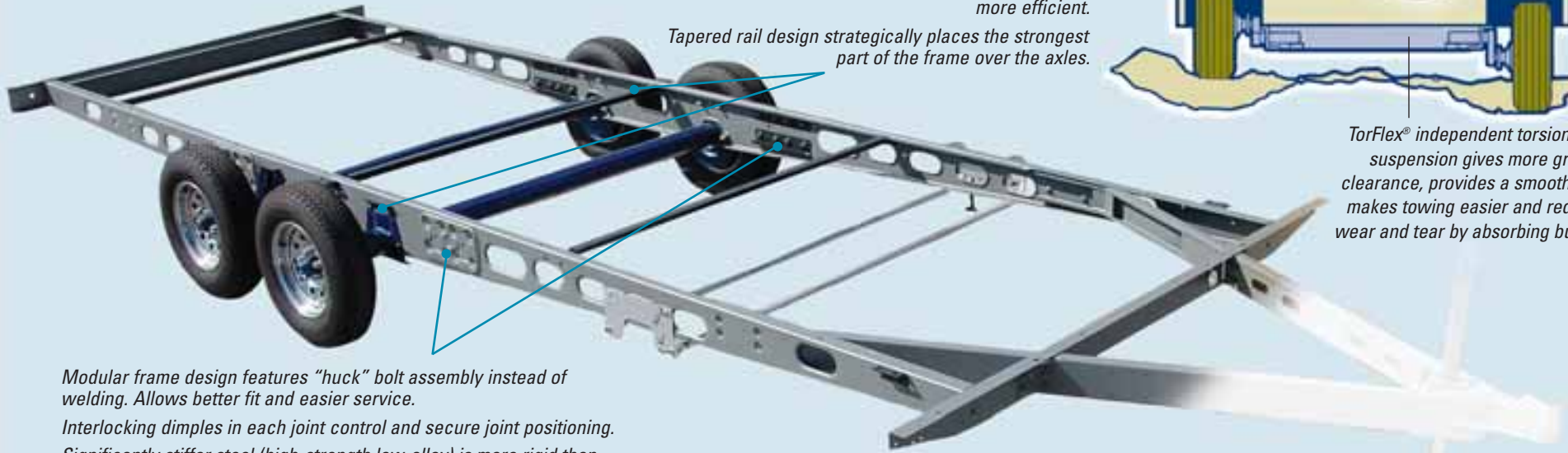

TorFlex<sup>®</sup> independent torsion-axle suspension gives more ground clearance, provides a smooth ride, makes towing easier and reduces wear and tear by absorbing bumps.

Modular frame design features "huck" bolt assembly instead of welding. Allows better fit and easier service.

Interlocking dimples in each joint control and secure joint positioning.

Significantly stiffer steel (high-strength low-alloy) is more rigid than the commercial-quality steel used in most conventional trailers.

The one-piece PolyFlex<sup>™</sup> underfloor covering makes towing easier by improving aerodynamics, and protects against road debris (enclosed underbelly on Jay Feather<sup>™</sup> LGT).

TuffShell<sup>™</sup> construction uses vacuum-bond laminated walls, roof and floor for smoother-looking, more durable walls than typical pinch roller construction.

E-Z Lube<sup>®</sup> axles with removable caps make maintenance simple.

Our rugged, corrosion-resistant frames feature a 12-stage E-Coat<sup>™</sup> finishing system and come with a lifetime warranty.

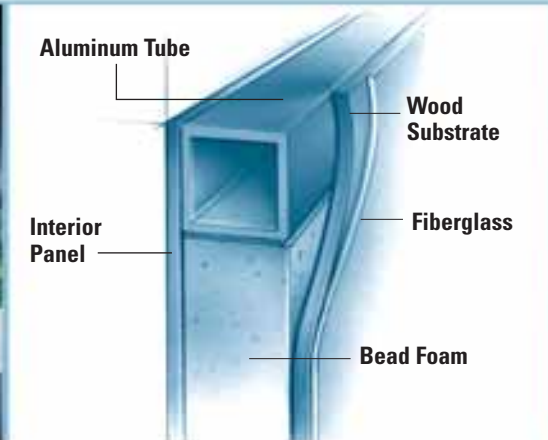





2005 Jay Feather<sup>®</sup> EXP

### Customer Value Package

- ABS tub surround*
- ABS gas bottle cover*
- 13,500-BTU A/C*
- Microwave oven with carousel*
- 6-gal. gas/electric water heater*
- Oversized oven*
- Carefree<sup>®</sup> patio awning*
- Outside shower*
- AM/FM/CD stereo with two speakers*
- Spare tire with carrier and vinyl cover*
- Stabilizer jacks (4)*



2005 Jay Feather<sup>®</sup> LGT

### Customer Value Package

- ABS tub surround*
- ABS gas bottle cover*
- 13,500-BTU central A/C*
- Microwave oven with carousel*
- 6-gal. gas/electric water heater*
- Oversized oven*
- Carefree<sup>®</sup> patio awning*
- Outside shower*
- AM/FM/CD stereo with two speakers*
- Spare tire with carrier and vinyl cover*
- Stabilizer jacks (4)*
- Chrome wheels*
- Innerspring mattress with struts*





## 2005 Jay Feather<sup>™</sup> Sport

# Travel light — leave all your burdens behind.

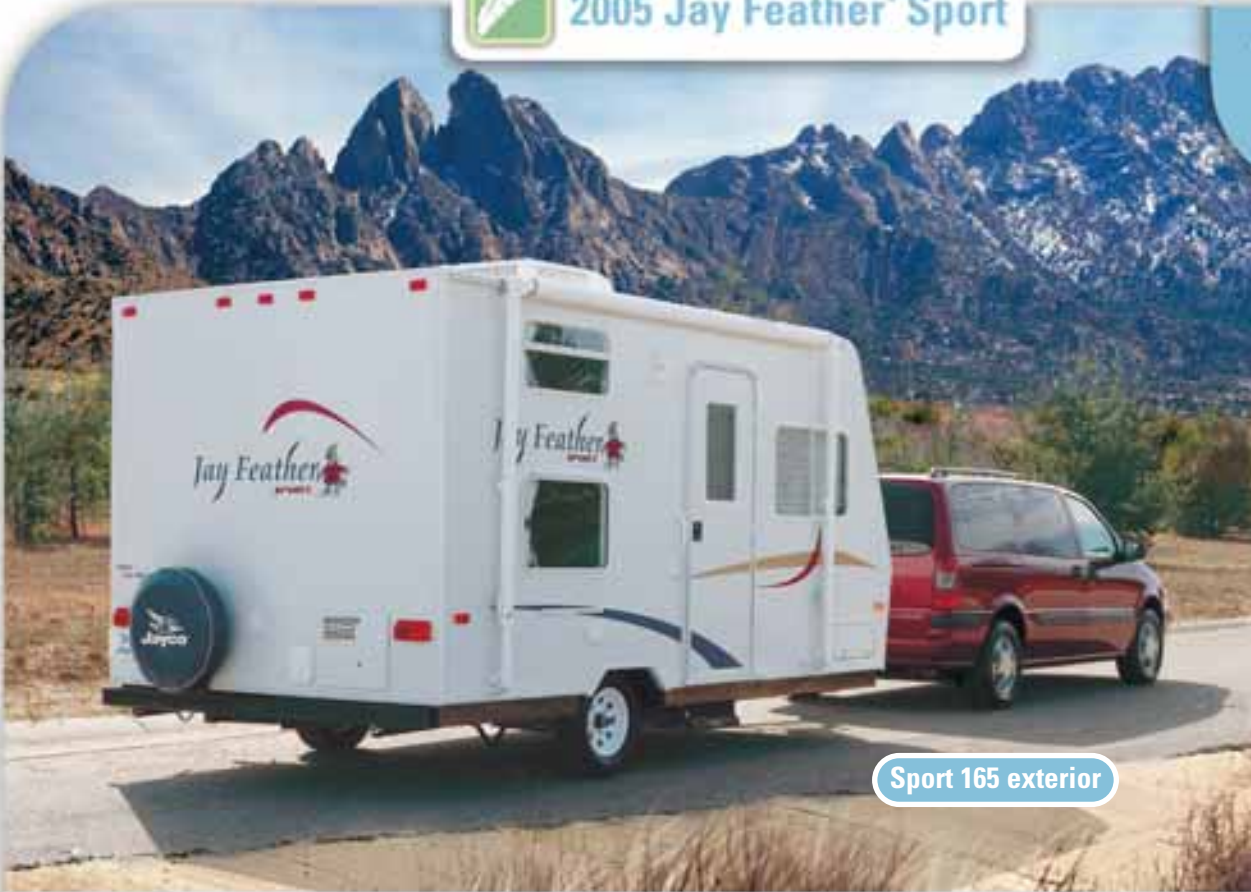

Sport 165 exterior

Jay Feather<sup>™</sup> Sport, our lightest-weight travel trailer, lets you tow behind the smallest tow vehicles. You may not have to upgrade your current family vehicle. And you get room for four, with a full 78" of headroom, anywhere you take it. It's the perfect size for a perfect outing.

Your Jay Feather<sup>™</sup> Sport slips through the air with Filon<sup>®</sup> fiberglass exterior sidewalls and a 26" white, radius-framed, smooth fiberglass entrance door.

A 20-lb. gas bottle provides power for appliances including water heater and 18,000-BTU furnace.



Be prepared with the optional spare tire with carrier and vinyl cover.

A bunk over the bed adds room for a child. The bathroom features all the essentials with a medicine cabinet with mirror and ABS tub/shower surround.

Two outside storage compartments provide extra space for essentials.

We fit everything you need into the kitchen, including flush-mounted 5-cu.-ft. refrigerator, 3-burner range with 9,000-BTU SuperBurner<sup>™</sup> and piezo igniter, microwave oven and optional 17" oven.



# 2005 Jay Feather™ Ultra Lite Weight travel trailer standards and options

## Standard Interior Equipment

	EXP	LGT	Sport
AM/FM/CD stereo with 2 speakers			■
Cable TV hookup with RG6 Coax	■	■	■
Choice furniture, designed and made by Jayco®	■	■	■
Crank-up TV antenna with signal booster	■	■	■
Mini-blinds	■	■	■
Overhead cabinetry is slanted (when possible)	■	■	■
Swivel rocker(s) (2) (29 N only)		■	
Vinyl flooring	■	■	■
Westview maple, flat-panel doors and drawers	■	■	■

## Standard Kitchen Equipment

	EXP	LGT	Sport
3-burner range with 9,000-BTU SuperBurner™ and piezo igniter	■	■	■
5-cu.-ft. flush-mount refrigerator	■	■	■
6-cu.-ft. flush-mount refrigerator	■	■	■
Cover for sink/cutting board (1)	■	■	■
High-rise mixing faucet	■	■	■
Large window	■	■	■
Microwave oven with carousel			■
Over-sized drawer in U-dinette	■	■	■
Range hood with light and exhaust fan	■	■	■
Wallpaper border	■	■	■
White, residential-style, double-bowl kitchen sink with 1 cover	■	■	■

## Standard Bedroom Equipment

	EXP	LGT	Sport
Bi-fold privacy door (N/A in 19 W)			■
Deep-quilted cushions for bunk(s)	■	■	■
Fan lights in bunk (2)	■	■	■
Quilted bedspread	■	■	■
Roof vent		■	
Shirt wardrobe	■	■	■
TV shelf (select models)		■	

## Standard Bathroom Equipment

	EXP	LGT	Sport
12V roof vent	■	■	■
Holder for towels	■	■	■
Marine toilet	■	■	■
Medicine cabinet with mirror	■	■	■
Shower curtain	■	■	■
Skylight in tub/shower (select models)	■	■	■

## Standard Safety Equipment

	EXP	LGT	Sport
Breakaway switch	■	■	■
Dual hitch safety chains	■	■	■
Fire extinguisher	■	■	■
Lock and dead bolt on entrance door	■	■	■
LP/gas leak detector	■	■	■
Multiple egress windows	■	■	■
Smoke detector	■	■	■
Windows with clear safety glass	■	■	■

## Standard Exterior Equipment

	EXP	LGT	Sport
2" hitch coupler (select models)	■	■	■
2-5/16" hitch coupler (select models)	■	■	■
10" electric brakes	■	■	■
13" radial tires	■	■	■
15" radial tires	■	■	■
110V G.F.C.I. Protected exterior receptacle	■	■	■
ABS fender skirts		■	
Camper-Tex™ water-repellent one-piece vinyl tent	■	■	■
Carefree® patio awning	■	■	■
Composite bumper extensions	■	■	■
E-Z Lube® axles	■	■	■
Fiberglass, radius cornered entrance door and screen door	■	■	■
Front window with flush-mounted stone guard		■	
Heavy-duty, retractable entrance step	■	■	■
HDPE wheel wells	■	■	■
Lockable end bunks	■	■	■
Lockable, radius cornered baggage doors with heavy-duty grab handle	■	■	■
MaxiStor™ (25 G only)	■	■	■
Molded ABS bumper cover		■	
Molded rain guttering with drip spouts	■	■	■
Painted bottom radius skirting		■	
Pass-through storage compartment	■	■	■
Patio light with inside switch	■	■	■
Prep for RVQ® outside grill	■	■	■
Sewer hose storage compartment	■	■	■
Stabilizer jacks (2 pair)	■	■	■
TorFlex® independent torsion-axle rubber ride suspension system	■	■	■
White-spoked wheels	■	■	■

## Standard Construction Features

	EXP	LGT	Sport
5/8" Seamless Structurwood® main floor decking with PolyFlex™ underbelly			■
78" ceiling height	■	■	■
Bead-foam insulation (R-7 roof/floor) (R-7 walls)	■	■	■
Cabinetry crafted with screwed stile construction	■	■	■
Cable support system for bunk ends	■	■	■
Electric-powered slideout	■	■	■
Enclosed underbelly		■	
Filon® fiberglass sidewall exteriors	■	■	■
One piece, seamless, TPO roof	■	■	■
PolyFlex™ one-piece covering for underbelly	■	■	■
Tubular aluminum sidewall framework	■	■	■
TuffShell™ vacuum-bond laminated roof, floor and sidewalls	■	■	■
Unitized, 1-1/2" laminated construction of floor	■	■	■
Weld-free modular HSLA steel frame with E-Coat™ protection	■	■	■

## Standard Heat, Power and Water Equipment

	EXP	LGT	Sport
12V demand water pump	■	■	■
12V electrical system with deluxe 110V 45-amp power converter	■	■	■
20-lb. LP gas bottle		■	
30-amp power cord	■	■	■
Auto-ignition furnace with wall thermostat	■	■	■
Double 20-lb. LP gas bottles, with auto-regulator (All EXP models and 19 W LGT model)	■	■	■
Double 30-lb. LP gas bottles, with auto-regulator		■	
Furnace is 18,000-BTU with auto-ignition	■	■	■
Gravity fill for water	■	■	■
Hookup for city water	■	■	■
Monitor panel for all systems	■	■	■
Outside shower	■	■	■
Rotocast fresh water holding tanks	■	■	■
Water heater bypass system	■	■	■
Winterization kit			■

## Optional Equipment

	EXP	LGT	Sport
17" oven			■
A/C, 13,500-BTU	■	■	■
Bunk over double bed (19 W)			■
Carpeting in bedroom (N/A in 19 W)	■	■	■
Customer Value Package (see below)	■	■	■
Drawer for exterior storage (N/A 19 W)	■	■	■
Exterior entertainment center	■	■	■
Heated bed mat(s) (1) (25 G)	■	■	■
Heated bed mat(s) (2) (N/A 25 G)	■	■	■
Portable, outside gas RVQ® grill with carrying case	■	■	■
Spare tire and tire carrier with vinyl tire cover	■	■	■
Water purification system	■	■	■

## Customer Value Package

	EXP	LGT	Sport
6-gal. gas/electric water heater	■	■	■
ABS tub surround	■	■	■
A/C, 13,500-BTU (with 19 W)	■	■	■
A/C (central), 13,500-BTU (N/A 19 W)	■	■	■
AM/FM/CD stereo with 2 speakers	■	■	■
Carefree® patio awning	■	■	■
Chrome racing wheels			■
Cover for LP gas bottle made of molded ABS	■	■	■
Innerspring mattress with bed struts	■	■	■
Microwave oven with carousel	■	■	■
Outside shower	■	■	■
Oversized oven	■	■	■
Spare tire and tire carrier			■
Spare tire and tire carrier with vinyl tire cover	■	■	■
Stabilizer jacks (2 pair)	■	■	■

## 2005 Jay Feather™ Sport travel trailer floor plans

165

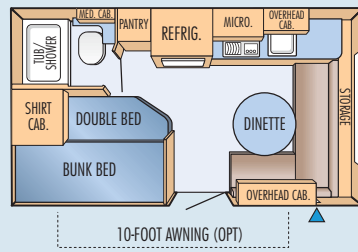

186

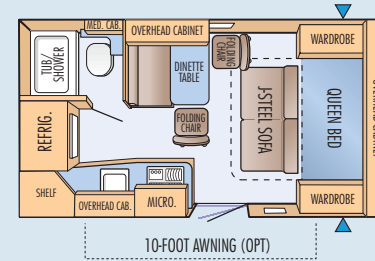

## 2005 Jay Feather™ EXP travel trailer floor plans

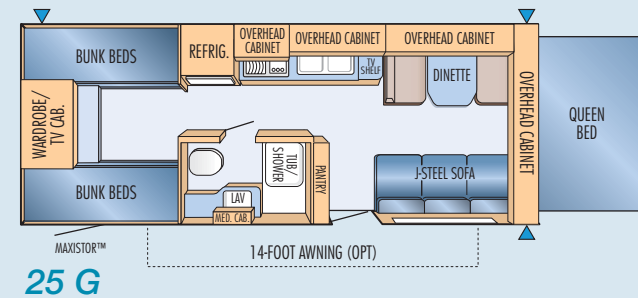
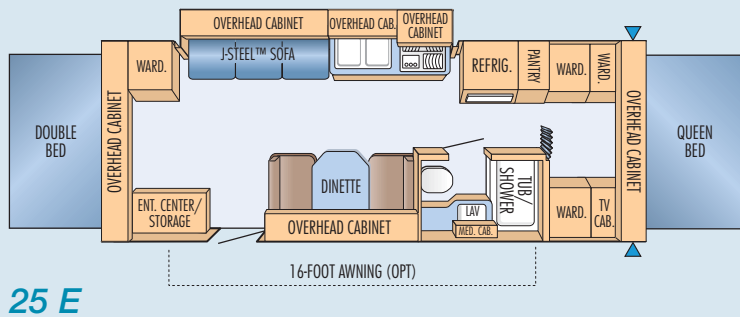
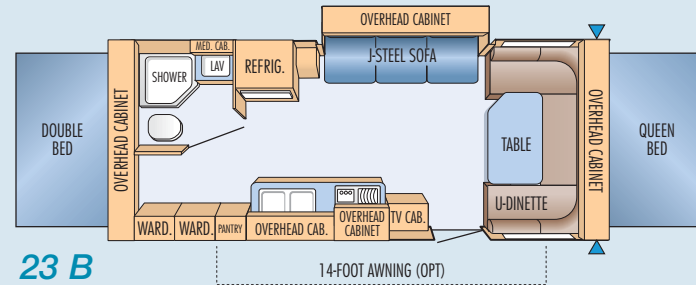
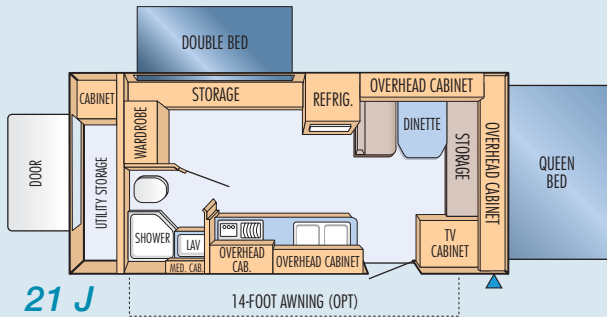
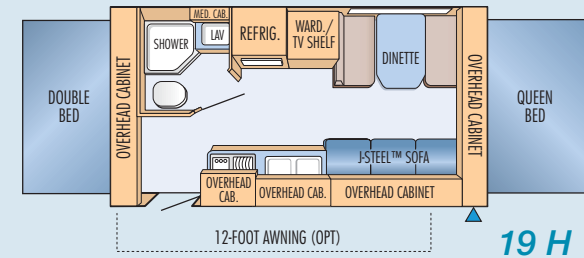
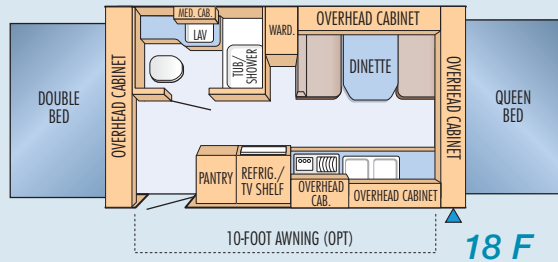

## 2005 Jay Feather™ LGT travel trailer floor plans

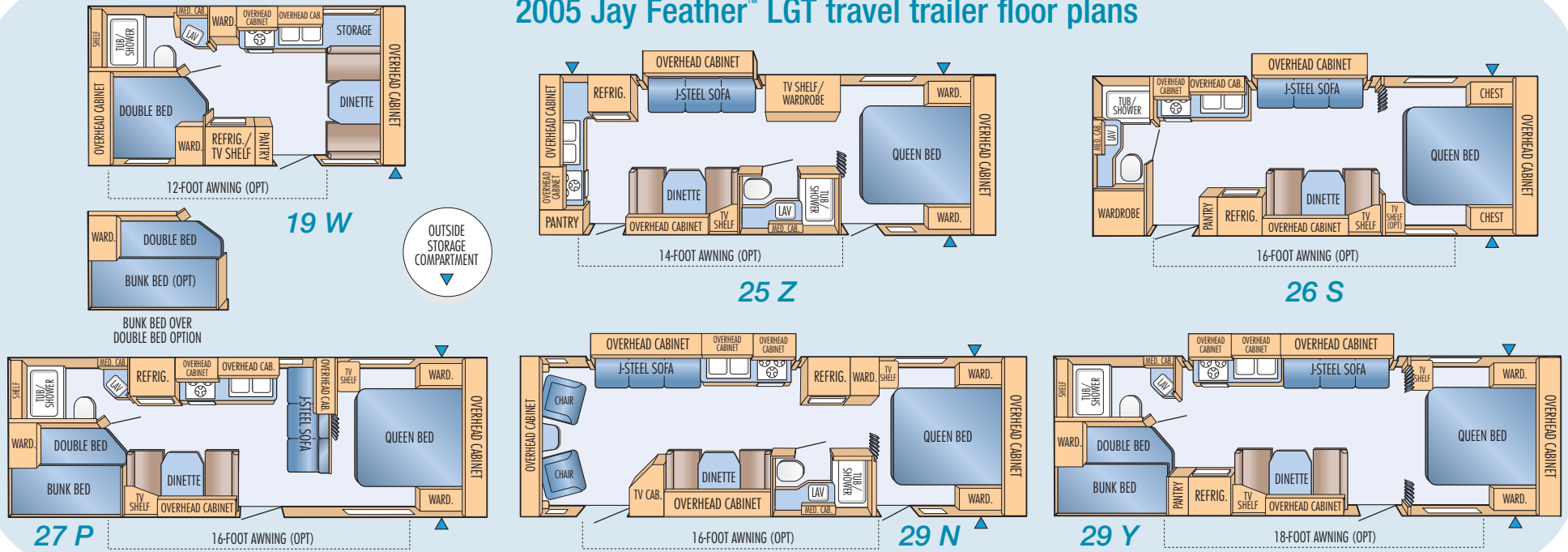

## 2005 Jay Feather™ Ultra Lite Weight travel trailer specifications

Models	Exterior Travel Length	Exterior Campsite Length	Exterior Width	Exterior Height w/opt AC	Interior Headroom	Unloaded Vehicle Weight (lbs.)	Hitch Weight (lbs.)	Gross Vehicle Weight Rating (lbs.)	Cargo Carrying Capacity (lbs.)	Fresh Water Capacity <sup>^</sup> (gals.)	Gray Water Capacity (gals.)	Toilet/Black Wastewater Capacity (gals.)	Exterior Storage (cubic ft.)
<b>Sport</b>													
165	17'-11"	17'-11"	7'-7"	114"	78"	2690	410	3500	810	30	30	11	—
186	*18'-11"	*18'-11"	*7'-7"	*114"	*78"	*3005	*460	*3910	*905	*30	*30	*11	—
<b>EXP</b>													
18 F	18'-2"	21'-6"	8'	115"	78"	2735	395	3750	1015	30	22	22	—
19 H	20'-2"	23'-1"	8'	116"	78"	3525	400	4400	875	30	30	22	—
21 J	*22'-2"	*25'-1"	*8'	*116"	*78"	*3875	*440	*4835	*960	*30	*30	*22	—
23 B	23'-11"	27'-1"	8'	115"	78"	4030	395	4950	920	30	29	22	—
25 E	26'-3"	29'-4"	8'	117"	78"	4535	640	5800	1265	30	29	22	—
25 G	26'-3"	26'-1"	8'	117"	78"	4180	610	5800	1620	30	29	22	—
<b>LGT</b>													
19 W	20'-4"	20'-4"	8'	117"	78"	3130	485	4550	1420	36	30	22	—
25 Z	27'-6"	27'-6"	8'	119"	78"	4635	605	5800	1165	36	30	22	—
26 S	27'-6"	27'-6"	8'	119"	78"	4110	475	5800	1690	30	30	22	—
27 P	29'-2"	29'-2"	8'	119"	78"	4520	670	6000	1480	36	30	22	—
29 N	30'-8"	30'-8"	8'	119"	78"	5065	770	6500	1435	36	30	22	—
29 Y	30'-8"	30'-8"	8'	119"	78"	5115	530	6500	1385	36	30	22	—

\*Estimated

**Unloaded Vehicle Weight (UVW):** Sometimes referred to as "Dry Weight," UVW means the typical weight of this trailer as built at the factory. The UVW, as used in product literature and other promotional materials, does not include cargo, fresh water, LP gas, options or dealer-installed accessories.

**Gross Vehicle Weight Rating (GVWR):** GVWR means the maximum permissible weight of the trailer, including the UVW plus passengers, personal items, all cargo, fluids, options and dealer-installed accessories. The GVWR is equal to or greater than the sum of the UVW and the CCC.

**Cargo Carrying Capacity (CCC):** CCC means the maximum weight of all passengers, personal items, food, fresh water, LP gas, tools, other cargo and dealer-installed accessories\* that can be carried by the trailer. CCC is equal to or less than GVWR minus UVW.

\*The addition of options will decrease the CCC.

It is important for your safety and enjoyment that your tow vehicle be adequately sized and equipped to tow and handle the GVWR of the RV you select. Review weights and rating of your tow vehicle and consult a competent advisor for questions or advice. Whether you are new to RVing or a

veteran, get a feel for the performance of your tow vehicle and the RV together before heading out on the roadways. **When you tow an RV, you must drive differently than you do when driving a single vehicle.** Practice hooking up, driving, backing up and braking in a safe environment or seek out professional instruction.

See specification chart above. Jayco® affixes a weight label to each new RV which lists weight information for that vehicle.

<sup>^</sup> Fresh water capacity includes 6-gal. for water heater

## Tow Ratings

The following tow ratings are the highest available for the respective 2004 model year vehicles shown. Certain optional equipment may be required and other restrictions may apply. Consult the latest manufacturer's towing guide (available at your automotive dealership) or your vehicle owner's manual to verify the tow ratings provided.

This information repurposed with permission from Trailer Life. Copyright 2004, TL Enterprises, Inc., 2575 Vista Del Mar Drive, Ventura, CA 93001.

VEHICLE	ENGINE	MAX TOW LIMIT (LBS.)
<b>BMW</b>		
X5 3.0i	3.0L I-6	5953
X5 4.4i, 4.6is	4.4L/4.6L V-8	5953
<b>BUICK</b>		
Rendezvous	3.4L V-6	3500
<b>CADILLAC</b>		
SRX	All	3500
Escalade EXT AWD	6.0L V-8	7400
<b>CHEVROLET/GMC</b>		
Astro/Safari CV RWD	4.3L V-6	5200
Avalanche RWD	5.3L V-8	8300
Blazer 4-door RWD	4.3L V-6	5700
Blazer 2-door RWD	4.3L V-6	5500
Canyon/Colorado Reg Cab RWD	3.5L I-5	3500
Canyon/Colorado Ext. Cab RWD	3.5L I-5	3600
Canyon/Colorado Reg Cab 4WD	3.5L I-5	3600
Sierra/Silverado 1500 Reg Cab RWD SB	4.3L V-6	3600
Sierra/Silverado 1500 Reg Cab 4WD SB	4.3L V-6	4800
Sierra/Silverado 1500 Ext. Cab RWD SB	4.3L V-6	4700
Sierra/Silverado 1500 Ext. Cab RWD SB	4.8L V-8	6100
Suburban/Yukon XL 1500 RWD	5.3L V-8	7400
Suburban/Yukon XL 2500 RWD	6.0L V-8	7900
Tahoe/Yukon RWD	4.8L V-8	5700
Tahoe/Yukon RWD	5.3L V-8	7700
Trailblazer/Envoy	4.2L I-6	5300
Trailblazer EXT/Envoy XL	4.2L I-6	5000
Trailblazer EXT/Envoy XL	5.3L V-8	5900
Yukon Denali AWD	6.0L V-8	8200
Yukon Denali XL AWD	6.0L V-8	8000

VEHICLE	ENGINE	MAX TOW LIMIT (LBS.)
<b>DAIMLER/CHRYSLER</b>		
Dodge Caravan FWD	3.3L/3.8L V-6	3800
Dodge Dakota Reg Cab RWD	4.7L V-8	5500
Dodge Dakota Reg Cab 4WD	4.7L V-8	6300
Dodge Durango ST RWD	3.7L V-6	3750
Dodge Durango Limited RWD	4.7L V-8	7450
Dodge Ram 1500 Reg Cab LB RWD	4.7L V-8	5500
Dodge Ram 1500 Reg Cab LB 4WD	4.7L V-8	6200
Pacifica	3.5L V-6	3500
Town & Country FWD	3.3L/3.8L V-6	3800
<b>FORD</b>		
Escape FWD, 4WD	3.0L V-6	3500
Excursion	5.4L V-8	7200
Expedition RWD	4.6L V-8	5000
Explorer RWD	4.0L V-6	5780
Explorer AWD	4.6L V-8	7000
Explorer Sport XLT RWD	4.0L V-6	5040
<b>HONDA</b>		
Odyssey LX, EX	3.5L V-6	3500
Pilot LX, EX	3.5L V-6	3500
<b>HUMMER</b>		
H1	6.5L V-8 TDI	8050
H2	6.0L V-8	6700
<b>ISUZU</b>		
Ascender RWD	4.2L I-6	5500
Ascender 4WD	5.3L V-8	6300
Axiom	3.5L V-6	7000
Rodeo/Rodeo Sport	3.2L V-6	4500
<b>JEEP</b>		
Grand Cherokee	4.7L V-8	6500
Liberty	3.7L V-6	5000
<b>KIA</b>		
Sedona	3.5L V-6	3500
Sorento	3.5L V-6	3500
<b>LEXUS</b>		
GX 470	4.7L V-8	5000
LX 470	4.7L V-8	6500
RX 300	3.3L V-6	3500
<b>LINCOLN</b>		
Aviator RWD/AWD	4.6L V-8	7300/7100
Navigator RWD/AWD	5.4L V-8	8600/8300
<b>MAZDA</b>		
Tribute	3.0L V-6	3500

VEHICLE	ENGINE	MAX TOW LIMIT (LBS.)
<b>MERCEDES-BENZ</b>		
G500	5.0L V-8	7000
G55AMG	5.5L V-8	7000
ML350	3.7L V-6	5000
ML500	5.0L V-8	5000
<b>MERCURY</b>		
Mountaineer AWD	4.6L V-8	6840
Mountaineer RWD	4.0L V-6	5620
Mountaineer RWD	4.6L V-8	6980
<b>MITSUBISHI</b>		
Montero/Montero Sport	All	5000
Endeavor AWD	3.8L V-6	3500
<b>NISSAN</b>		
Frontier 4WD	3.3L V-6 SC	5000
Murano FWD, AWD	3.5L V-6	3500
Pathfinder	3.5L V-6	5000
Pathfinder Armada	5.6L V-8	6500
Titan King/Crew Cab/RWD/4WD	5.6L V-8	6500
Xterra	2.4L I-4	3500
Xterra	3.3L V-6	5000
<b>OLDSMOBILE</b>		
Bravada	4.2L I-6	6300
Silhouette	3.4L V-6	3500
<b>PONTIAC</b>		
Aztek	3.4L V-6	3500
Montana	3.4L V-6	3500
<b>TOYOTA</b>		
4Runner RWD/AWD	3.4L V-6	5000
Land Cruiser	4.7L V-8	6500
Sequoia RWD	4.7L V-8	6500
Sequoia 4WD	4.7L V-8	6200
Sienna	3.3L V-6	3500
Tacoma	All I-4	3500
Tacoma	3.4L V-6	5000
Tundra RWD	3.4L V-6	5000
Tundra 4WD	4.7L V-8	7200
<b>VOLKSWAGEN</b>		
Eurovan	2.8L V-6	4400
Touareg	All	7716
<b>VOLVO</b>		
XC90 AWD	All	4960



## EXP and LGT Interior Color Selections



Apple Pie



Blueberry Buckle

### We back what we build



The Jayco<sup>®</sup> **2+3 Warranty** is a manufacturer's limited warranty. It doesn't come from your dealer and it's not an extended warranty! It comes from the people who build Jayco

recreational vehicles to the people who buy them. Each Jayco is warranted to the original purchaser for twenty-four (24) months from the date of purchase against defects in materials and workmanship. The Jayco warranty includes a limited three-year (3) structural guarantee. In addition, our limited

warranty may be transferred one time within the first two (2) years. Go ahead and compare the Jayco warranty with other manufacturers' warranties. You'll find it's the best in the business! For a copy of the limited warranty with full terms and conditions, ask your local Jayco dealer or visit our Web site.

We also offer **five-year (5) coverage** on our tent with parts, labor and freight covered the first two years; parts, factory labor and return freight during years three, four and five.



In the heart of the Midwest, old-world craftsmen have handed down tried-and-true construction methods from

generation to generation. At our headquarters in Middlebury, Indiana, Jayco continues this tradition when building all of our recreational vehicles. Our rugged designs, solid construction and commitment to quality add up to a well-built vehicle you can depend on for years.



## Popular Jay Feather<sup>®</sup> LGT options

# Now you know why mom told you to go play outside.



*The molded ABS rear bumper cover creates a smooth, attractive surface.*



*Take your tunes outdoors with the optional outside entertainment center, equipped with a spare 110V duplex power outlet and a durable, waterproof locking cover.*



*Reach stored items easily in the optional front storage compartment pull-out tray.*

**See dealer for further information and prices.**

Colton RV  
North Tonawanda, NY 14120  
(716) 694-0188  
(800) 628-4889  
[www.ColtonRV.com](http://www.ColtonRV.com)

Colton RV  
Orchard Park, NY 14127  
(716) 957-3250  
(800) 628-4889  
[www.Coltonrv.com](http://www.Coltonrv.com)

RVQ is a registered trademark of Vitco, Inc.  
TorFlex is a registered trademark of the Dexter Axle Co.  
E-Z Lube is a registered trademark of the Dexter Axle Co.  
Filon is a registered trademark of Kemlite Company, Inc.  
Camper-Tex is trademarked by Bruin Plastics Co., Inc.  
Carefree is a registered trademark of Carefree of Colorado.



**FAMILY OWNED. FAMILY FOCUSED.**

Jayco, Inc. P.O. Box 460 Middlebury, IN 46540  
[www.jayco.com](http://www.jayco.com)



As a Jayco owner, you can be part of the Jayco Jafari International Travel Club. Ask your dealer about the Jafari "flight" in your area, write Jayco direct or visit our Web site.  
Jayco is a registered trademark of Jayco, Inc.

**Please Note:** All information in this brochure is the latest available at the time of publication approval. Jayco reserves the right to make changes and to discontinue models without notice or obligation.

**Part No. 0501005.2005**

Pictures in this brochure may show optional equipment. RVs built for sale in Canada may differ to conform to Canadian codes.

Printed on recycled paper.



©2004 Jayco, Inc. 0604-100M Litho in U.S.A.