

# nüCamp

TO BUILD THE EXCEPTIONAL



**T@G**  
TEARDROP TRAILERS

**T@B**  
TEARDROP CAMPERS

**T@B 400**  
TEARDROP CAMPERS

[nucamprv.com](http://nucamprv.com)

TO BUILD THE EXCEPTIONAL





# nuCamp

Each nuCamp product is meticulously handmade in Sugarcreek, Ohio. To build the exceptional isn't just a slogan – we are passionate about creating amazing products and have a strong sense of pride in everything we do.

Our focus is on quality and customer care. Our skilled craftsmen and women are committed to building with integrity and embracing innovative design. Our superior construction techniques and strict quality control set us apart from other recreational vehicle manufacturers.

When you own a nuCamp product, you gain access to a first-class customer experience, receive outstanding support, and become part of a welcoming community. *Your journey begins here.*



TAB S – Seating Area

Our European-influenced design creates an inviting, modern space to make your camping experience a pleasure. We aim to build beautifully designed, compact trailers without compromising on the comforts of home.



TAB 400 – Wet Bath



TAB CS-S – Full Sleeping Area Setup



TAG XL – Interior



TAB 400 – Kitchen

# T@G

## TAG TEARDROP TRAILERS



### LIGHTWEIGHT & EASY TO TOW

TAG Teardrop Trailers are packed with all the necessary amenities to ensure a comfortable adventure. While preparing meals, the well-equipped rear galley kitchen allows you to enjoy the surrounding nature. You can relax in the spacious yet cozy interior, featuring a large window for stargazing. The TAG XL offers a 12-inch expanded interior if you desire more space. Wherever your adventures take you, the nuCamp TAG Teardrop Trailer is always ready to accompany you on your exciting journey.

**BOONDOCK**  
EDITION

The TAG Boondock Edition has everything you want to enhance your camping experience. It comes standard with large, aggressive off-road wheels/tires. It has a pitched axle, rugged-style fenders and entry handles, along with a sturdy, aluminum utility platform that can carry all your gear.

**BOONDOCK**  
*BLACK CANYON*

**BOONDOCK BLACK CANYON  
UPGRADE:**

Additional 120-watt Solar Panel

Water Heater

Holding Tank Heater

Under-Glow Lights

Tri-Fold, Multifunctional Mattress

**classic**

The Classic Package streamlines the TAG by exchanging the wheels, tires, fenders, axle, and entry door handle for a more traditional touring style. The 30L 12-volt cooler is replaced with an Otterbox® backpack cooler. The rugged, aluminum utility platform and roof rack are removed. (*Black Canyon upgrade not available for this package.*)



## BASE PACKAGE

- Deluxe Amish Cabinetry
  - Split Mattress
  - Under Bed Storage
  - Stargazer Window
  - A/C & Electric Heater
  - Stainless Steel Sink
  - 2-Burner Stove (TAG Equipped w/ 1-Burner)
  - 30L 12-volt Cooler
  - Power Roof Fan
  - Composite Flooring
  - Molded Underbelly Shield
  - Full Size Spare
  - Electric Brakes
  - 23 gal Freshwater Tank
  - External Shower
  - External LP Hook-Up
  - Removable Cutting Board
  - Aggressive Off-Road Tires Diamond Plate Storage Tub Aluminum Utility Platform
  - Cargo Pouches
  - Roof Rack
  - Pitched Axle
  - Boondock Entry Door Handle
  - Custom Running Boards & Fenders
  - Boondock Graphic
  - Removable Cutting Board
- (Not Available w/ Classic Package)

## CONVENIENCE PACKAGE

- 180-watt Solar Panel
- External Solar Port
- Intelligent Battery Detection Converter
- Portable Bluetooth® Speaker
- 100 Ah 12-volt Lithium Battery
- Bluetooth® Battery Monitor Smartshunt

## TRIM COLORS



## ROOF/HATCH COLORS

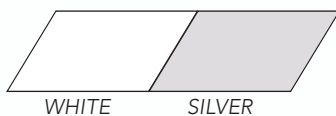

## SIDEWALL COLORS

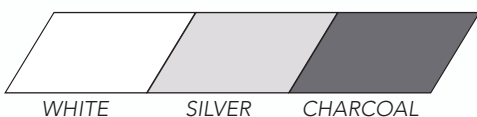

## GRAPHIC OPTIONS



## ADD-ON



Microwave Oven



Tri-Fold, Multifunctional Mattress



Roof Rack  
(Classic Package Only)



Aluminum Utility Platform  
(Classic Package Only)

## LITHIUM BATTERY UPGRADE



- 200 Ah 12-volt Lithium Battery Bank w/ Internal Heat
- 2,000-watt MultiPlus Inverter/Charger



Proudly handcrafted in the heart of Ohio's Amish country.

# T@B

## TAB S TEARDROP CAMPER



### THE ICONIC TEARDROP CAMPER

Experience the timeless charm of the TAB 320 S, the iconic teardrop trailer that revolutionizes compact camping while ensuring you have all the essential amenities. This camper boasts a galley kitchen, a convenient wet bath, and a versatile U-shaped dinette that effortlessly transforms into a cozy sleeping space. Whether embarking on a short weekend escape or an extended camping expedition, the TAB Teardrop Camper provides everything you need for a delightful and comfortable camping experience.

**BOONDOCK**  
EDITION

The TAB S Boondock Edition has everything you want to enhance your camping experience. It comes standard with large, aggressive off-road wheels/tires. It has a pitched axle, rugged-style fenders and entry handles, along with a sturdy, aluminum utility platform that can carry all your gear.

**BOONDOCK**  
*BLACK CANYON*

**BOONDOCK BLACK CANYON  
UPGRADE:**

- Solar Upgrade to Two 190-watt Panels
- Holding Tank Heaters
- Under-Glow Lights

**classic**

The Classic Package streamlines the TAB S by exchanging the wheels, tires, fenders, axle, entry door handle, and step for a more traditional touring style. The rugged, aluminum utility platform is removed. *(Black Canyon upgrade not available for this package.)*





## BASE PACKAGE

- Premium Soft Close Cabinetry
- Alde® Heating/Hot Water System
- Central A/C
- Expandable Split Bed
- Front Window
- Bluetooth® Media Center w/ 19" TV
- Stainless Steel Sink
- 2-Burner Glass-Top Stove
- 2.3 cu ft. 12v Compressor Refrigerator
- Lagun Table w/ External Mount
- Cassette Toilet w/ Molded Sink
- Power Roof Fan
- Side Porthole Windows
- Composite Flooring
- Molded Underbelly Shield
- 14" Steel Spare Tire
- Alloy Wheels
- Electric Brakes
- Nautilus w/ External Shower
- External LP Hook-Up
- Diamond Plate Storage Tub
- Custom Trim Kit w/ Molded Keder Rail
- Aggressive Off-Road Tires
- Pitched Axle
- Boondock Molded Fenders
- Boondock Entry Door Handle & Step
- Aluminum Utility Platform
- Rear Aluminum Cage

## CONVENIENCE PACKAGE

- 180-watt Solar Panel
- External Solar Port
- 100 Ah 12-volt Lithium Battery
- Intelligent Battery Detection Converter
- Bluetooth® Battery Monitor Smartshunt

### TRIM COLORS



### ROOF COLORS

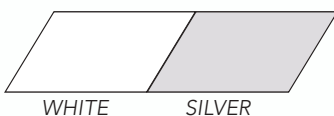

### SIDEWALL COLORS

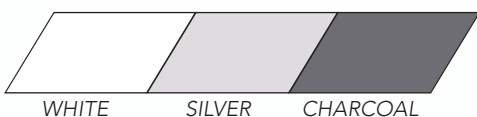

### GRAPHIC OPTIONS



### ADD-ON



Microwave Oven



Boondock Spare Tire



Roof Rack  
(Classic Package Only)



Aluminum Utility Platform  
(Classic Package Only)

### LITHIUM BATTERY UPGRADE



- 200 Ah 12-volt Lithium Battery Bank w/ Internal Heat
- 2,000-watt MultiPlus Inverter/Charger



Proudly handcrafted in the heart of Ohio's Amish country.

# T@B

## TAB CS-S TEARDROP CAMPER



CLASSIC PACKAGE SHOWN

### CAMPING THE WAY NATURE INTENDED

Immerse yourself in nature's beauty while enjoying the convenience of a well-equipped outdoor kitchen. The rear hatch of the TAB CS-S Teardrop Camper opens up to reveal a kitchen with a sink, stovetop, and plenty of counter space. This traditional clamshell teardrop design features a spacious dinette that easily converts into a cozy sleeping area. In addition, there is a private wet bath for your convenience. Experience the great outdoors with the TAB CS-S Teardrop Camper!

### **BOONDOCK** EDITION

The TAB CS-S Boondock Edition has everything you want to enhance your camping experience. It comes standard with large, aggressive off-road wheels/tires. It has a pitched axle, rugged-style fenders and entry handles, along with a sturdy, aluminum utility platform that can carry all your gear.

### **BOONDOCK** *BLACK CANYON*

**BOONDOCK BLACK CANYON  
UPGRADE:**

- Additional 180-watt Solar Panel
- Holding Tank Heaters
- Under-Glow Lights

### classic

The Classic Package streamlines the TAB CS-S by exchanging the wheels, tires, fenders, axle, entry door handle, and step for a more traditional touring style. The rugged, aluminum utility platform is removed. *(Black Canyon upgrade not available for this package.)*



## BASE PACKAGE

- Premium Soft Close Cabinetry
- Alde® Heating/Hot Water System
- Central A/C
- Expandable Split Bed
- Front Window
- Bluetooth® Media Center w/ 19" TV
- Stainless Steel Sink
- 2-Burner Glass-Top Stove
- 45L 12-volt Camco Cooler
- Lagun Table w/ External Mount
- Cassette Toilet w/ Molded Sink
- Power Roof Fan
- Side Porthole Windows
- Composite Flooring
- Molded Underbelly Shield
- 14" Steel Spare Tire
- Alloy Wheels
- Electric Brakes
- Nautilus w/ External Shower
- External LP Hook-Up
- Diamond Plate Storage Tub
- Custom Trim Kit w/ Molded Keder Rail
- Aggressive Off-Road Tires
- Pitched Axle
- Boondock Molded Fenders
- Boondock Entry Door Handle & Step
- Aluminum Utility Platform

## CONVENIENCE PACKAGE

- 180-watt Solar Panel
- External Solar Port
- 100 Ah 12-volt Lithium Battery
- Intelligent Battery Detection Converter
- Bluetooth® Battery Monitor Smartshunt

## TRIM COLORS



BRIGHT WHITE   STEEL GRAY   JET BLACK   HARVEST RED

## ROOF/HATCH COLORS

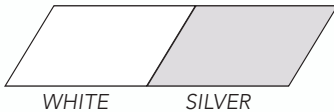

WHITE   SILVER

## SIDEWALL COLORS

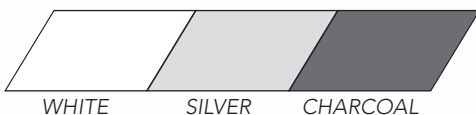

WHITE   SILVER   CHARCOAL

## GRAPHIC OPTIONS



LEGACY



ACCENT STRIPE



RIDGE

## ADD-ON



Microwave Oven



Boondock Spare Tire



Aluminum Utility Platform  
(Classic Package Only)

## LITHIUM BATTERY UPGRADE



- 200 Ah 12-volt Lithium Battery Bank w/ Internal Heat
- 2,000-watt MultiPlus Inverter/Charger



Proudly handcrafted in the heart of Ohio's Amish country.

# T@B 400

## TAB 400 TEARDROP CAMPER



### OUR LARGEST TEARDROP CAMPER

Our largest camper has much to offer but remains true to what makes a teardrop a teardrop. The TAB 400 truly becomes your home on wheels with its comprehensive features. This versatile trailer offers a comfortable dinette, a dedicated queen-size bed, a spacious wet bath, a galley kitchen, and ample storage. Its second sleeping area, or optional hide-a-way bunk bed floor plan makes this a perfect teardrop for small families or grandparents who enjoy occasional camping trips with their grandchildren.

**BOONDOCK**  
EDITION

The TAB 400 Boondock Edition has everything you want to enhance your camping experience. It comes standard with large, aggressive off-road wheels/tires. It has a pitched axle, rugged-style fenders and entry handles, along with a sturdy, aluminum utility platform that can carry all your gear.

**BOONDOCK**  
*BLACK CANYON*

**BOONDOCK BLACK CANYON  
UPGRADE:**

- Additional 310-watt Solar Panel
- Holding Tank Heaters
- Under-Glow Lights

**classic**

The Classic Package streamlines the TAB 400 by exchanging the wheels, tires, fenders, axle, and entry door handle for a more traditional touring style. The rugged, aluminum utility platform is removed. *(Black Canyon upgrade not available for this package.)*



## BASE PACKAGE

- Premium Soft Close Cabinetry
- Alde® Heating/Hot Water System
- Central A/C & Heat Exchange
- Froli™ Sleep System
- Rear Stargazer Window
- Bluetooth® Media Center w/ 24" TV
- Round, Glass-Top Stainless Steel Sink
- 2-Burner Glass-Top Stove
- 4.6 cu ft. 12v Compressor Refrigerator
- Power Roof Fan
- Monster Picture Window
- Composite Flooring
- Molded Underbelly Shield
- 15" Steel Spare Tire
- Electric Brakes
- Nautilus w/ External Shower
- External LP Hookup
- Diamond Plate Storage Tub
- Lagun Table w/ External Mount  
*(Bunk Floor Plan Only)*
- Aggressive Off-Road Tires
- Pitched Axle
- Boondock Entry Door Handle
- Aluminum Utility Platform

## CONVENIENCE PACKAGE

- 310-watt Solar Panel
- External Solar Port
- Intelligent Battery Detection Converter
- 100 Ah 12-volt Lithium Battery
- 1,200-watt Power Inverter
- Bluetooth® Battery Monitor Smartshunt

## ADD-ON



Microwave  
Oven



Aluminum Utility  
Platform  
*(Classic Package Only)*

## TRIM COLORS



BRIGHT WHITE   STEEL GRAY   JET BLACK   HARVEST RED

## ROOF COLORS



WHITE   SILVER

## SIDEWALL COLORS



WHITE   SILVER   CHARCOAL

## GRAPHIC OPTIONS



FRONTIER



ACCENT STRIPE



TEMPEST



Proudly handcrafted in the heart of Ohio's Amish country.

## LITHIUM BATTERY UPGRADE



- 400 Ah 12-volt Lithium Battery Bank w/ Internal Heat
- 3,000-watt MultiPlus Inverter/Charger

# TAB 400

## BUNK BED

The 2024 TAB 400 has an optional floor plan with a built-in hide-away bunk bed. This bunk provides extra sleeping space when needed and is neatly out of sight when you don't.



ENHANCE YOUR NUO



Bunk Bed Neatly Hidden Away

# uCamp:the app

Embark on a delightful journey with our app, where each moment effortlessly becomes a cherished memory, ready for you to capture its essence. Effortlessly plan your adventures, immortalize your experiences, and easily share them with your loved ones. The unique connect feature simplifies the process and fosters lasting connections with fellow nuCampers, turning your travels into meaningful friendships. Don't miss the opportunity to make your next trip memorable. Download our app and let the joy of shared moments unfold.



# CAMP EXPERIENCE EVEN MORE



## ULTIMATE PROTECTION PLAN

TRANSFERABLE 7-YEAR WARRANTY

### PEACE OF MIND WHEN TRAVELING

With the Ultimate Protection Plan, once you purchase it, **you won't ever have to pay any fees or deductibles** for the life of the contract.

If something happens to go wrong with your nuCamp product over the next seven years, just reach out to your dealer, file a claim, and take your unit to the nearest approved RV service center or the nuCamp Service Center.

*Take away all the worry of unforeseen costly repairs* and focus on maximizing all your adventures in your nuCamp RV.



**7-YEAR TRANSFERABLE WARRANTY**

Covers workmanship and components nationwide.



**NO DEDUCTIBLE EVER!**

Plus, no cancellation fees for a hassle-free claim process.



**100% MANAGED BY NUCAMP**

One call takes care of it all, saving you time and effort.



**1-YEAR MEMBERSHIP**

For a limited time, purchase the Ultimate Protection Plan and receive a free one year classic membership to Harvest Host. Membership requires a self-contained camper. TAG and TAB CS-S owners will receive a gift card of equal value.



Our story begins in the heart of Ohio Amish country. A minister by calling, and a plumber by trade, at the age of 44, Joe Mullet found himself building lawn furniture. While he was committed to both quality and innovation, he was longing for something more, something different.

In 2003, Joe was presented with the opportunity to build teardrop trailers – and a new journey began. Within one year, Pleasant Valley Teardrop Trailers was officially founded, and the boutique operation moved out of Joe’s garage and into a 3,000-square-foot shop with a small team of local craftsmen.

Joe was intentional about creating a culture that cared deeply – not only for his team, but also for the product and the customer. The company hand-built fifty campers during its first full year in business. It continued to grow, expanding its product offering, factory size, and workforce.

Success followed over the next few years; however, as the recession of 2008 took its toll on the industry, Pleasant Valley joined dozens of other RV manufacturers and was forced to close its doors. That same day, opportunity came knocking. Within a matter of months, Joe was able to get back on his feet, reassemble his team, and start anew – this time with the assistance of a national distributor.

In the years that followed, the company acquired the rights to build the iconic TAB Teardrop Camper, created the TAG Teardrop Trailer, and ventured into a new world with the Cirrus Truck Camper. As Pleasant Valley found itself outgrowing the need for a distributor, the company knew it was time to rebrand. In 2016, the name nuCamp was selected as the company sought to honor the community’s German heritage, celebrate its new beginnings, and tip its hat to the industry.

With the mission ‘to build the exceptional’ nuCamp chooses to place quality and customer care squarely at the center of everything they do. Perhaps that is why nuCamp continues to hold the title as the world’s largest manufacturer of teardrop trailers!







POWERED BY THE SUN

667



2024  
SPECS

T@GXL

T@BS



BLACK CANYON PACKAGE SHOWN



BLACK CANYON PACKA

	TAG • TAG XL BOONDOCK	TAG • TAG XL BLACK CANYON	TAG • TAG XL CLASSIC
Total Exterior Length	13' 7"	13' 7"	13' 7"
Exterior Width	6' 10" • 7' 10"	6' 10" • 7' 10"	6' 8" • 7' 8"
Exterior Height	6' 9"	6' 9"	6' 2" • 6' 3"
Sleeping Area	58" x 78" • 70" x 78"	58" x 78" • 70" x 78"	58" x 78" • 70" x 78"
Interior Height	43"	42"	43"
Fresh Water	23 gal	23 gal	23 gal
Gray Water	N/A	N/A	N/A
Black Water	N/A	N/A	N/A
Tire Size	235/75R15	235/75R15	175/80R13
GAWR	2,200 lbs	2,200 lbs	2,200 lbs
Tongue Weight (Dry)	172 lbs • 184 lbs	156 lbs • 168 lbs	135 lbs • 145 lbs
Total Gross Weight (Dry)	1,492 lbs • 1,594 lbs	1,590 lbs • 1,622 lbs	1,341 lbs • 1,405 lbs

	TAB S BOONDOCK	TAB S BLACK CANYON	TAB S CLASSIC
Total Exterior Length	15' 6"	15' 6"	15' 6"
Exterior Width	6' 9"	6' 9"	6' 9"
Exterior Height	8' 2"	8' 2"	8' 2"
Sleeping Area	71" x 72"	71" x 72"	71" x 72"
Interior Height	69"	69"	69"
Fresh Water	19 gal	19 gal	19 gal
Gray Water	18 gal	18 gal	18 gal
Black Water	5 gal	5 gal	5 gal
Tire Size	235/75R15	235/75R15	235/75R15
GAWR	3,000 lbs	3,000 lbs	3,000 lbs
Tongue Weight (Dry)	172 lbs	159 lbs	159 lbs
Total Gross Weight (Dry)	2,043 lbs	2,081 lbs	2,081 lbs



CLASSIC PACKAGE SHOWN

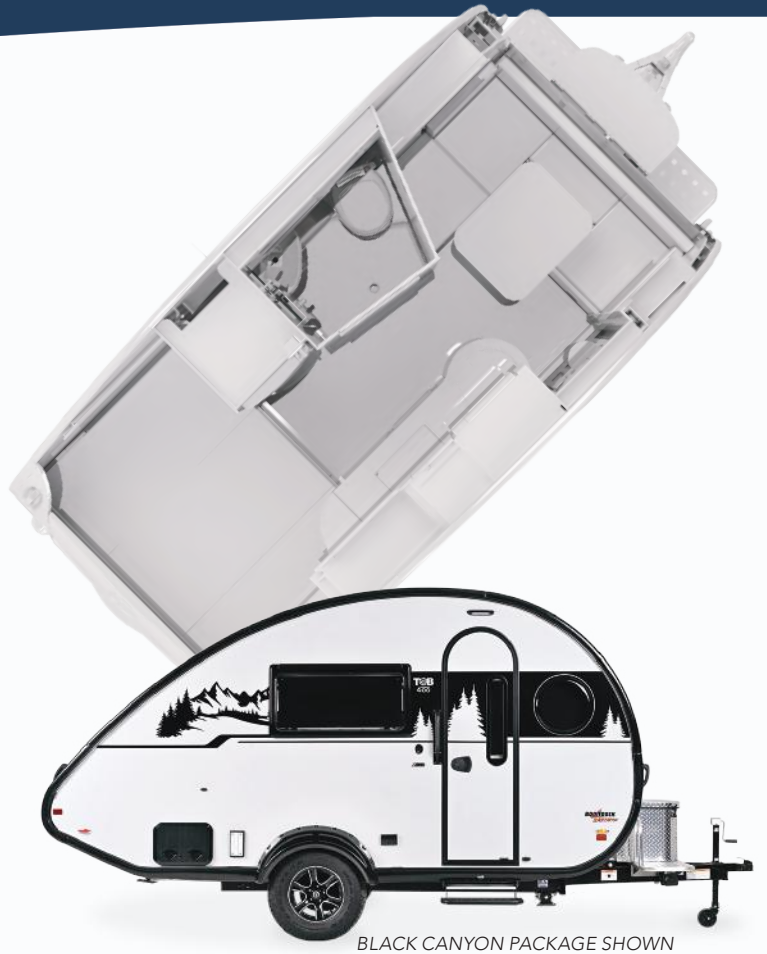

BLACK CANYON PACKAGE SHOWN

TAB S CLASSIC	TAB CS-S BOONDOCK	TAB CS-S BLACK CANYON	TAB CS-S CLASSIC	TAB 400 BOONDOCK	TAB 400 BLACK CANYON	TAB 400 CLASSIC
15' 3"	15' 6"	15' 6"	15' 3"	18' 3"	18' 3"	18' 3"
6' 8"	6' 9"	6' 9"	6' 8"	7' 8"	7' 8"	7' 7"
7' 8"	8'	8'	7' 6"	8' 11"	8' 11"	8' 9"
71" x 72"	58" x 71"	58" x 71"	58" x 71"	55" x 79"	55" x 79"	55" x 79"
69"	69"	69"	69"	79"	79"	79"
19 gal	19 gal	19 gal	19 gal	25 gal	25 gal	25 gal
18 gal	18 gal	18 gal	18 gal	18 gal	18 gal	18 gal
5 gal	5 gal	5 gal	5 gal	16 gal	16 gal	16 gal
205/75R14	235/75R15	235/75R15	205/75R14	235/75R15	235/75R15	205/75R15
3,000 lbs	3,000 lbs	3,000 lbs	3,000 lbs	3,900 lbs	3,900 lbs	3,900 lbs
126 lbs	300 lbs	288 lbs	250 lbs	399 lbs	385 lbs	390 lbs
1,994 lbs	2,146 lbs	2,184 lbs	2,092 lbs	2,911 lbs	2,940 lbs	2,877 lbs

Dry weight is the weight of the camper with standard equipment, excluding: propane, tank fluids, cargo, and optional equipment. TAB 400 secondary sleeping area size = 31" x 74". TAB 400 bunk sleeping area = 22" x 66". TAB bunk floor plan adds 28 lbs & 37 lbs to the tongue and total gross weights.

OUR  
**★ PLEDGE ★**  
TO THE CUSTOMER

When you purchase a nuCamp product, you get more than just a camper. You become part of the nuCamp family — complete with a welcoming community and unparalleled support. Our number one priority is your happiness, and we proudly guarantee your product to be exceptional.

**1 YEAR**  
CRAFTSMANSHIP  
WARRANTY

nuCamp agrees to warrant the integrity of the 2024 camper for up to one (1) year from the date of purchase (Warranty Period). This does not include equipment or parts with separate, stand-alone warranties.

**3 YEAR**  
STRUCTURAL  
WARRANTY

The 3-year structural warranty consists of the workmanship attributable to nuCamp's manufacturing and assembly of structural components. nuCamp agrees to warrant the structural integrity of the camper for up to three (3) years from the purchase date (Warranty Period). The 3-year structural warranty is transferable.

**ULTIMATE  
PROTECTION  
PLAN**



TRANSFERABLE  
7-YEAR WARRANTY

Extend your warranty protection to a full seven years. The Ultimate Protection Plan covers craftsmanship and components with no deductibles and a hassle-free claim process, providing peace of mind while on the road.

Colton RV & Marine  
3122 Niagara Falls Blvd.  
North Tonawanda, NY 14120  
(716) 694-0188  
[www.ColtonRV.com](http://www.ColtonRV.com)

Colton RV  
489 Bushkill Plaza LN #9665  
Wind Gap, PA 18091  
(610) 863-5239  
[www.ColtonRV.com](http://www.ColtonRV.com)

**nuCamp**

661 Belden Parkway NE  
Sugarcreek, Ohio 44681

330-852-4811 | [nucamprv.com](http://nucamprv.com)



© nuCamp. Rights reserved. nuCamp reserves the right to make refinements and changes during the model year, including but not limited to materials, components, colors, and specifications without notice. All weights, capacities, and dimensions are approximate. It is the owner's responsibility to select the suitable tow vehicle and tow equipment for proper and safe operation.  
TEARDROP-2024.1

