

2012 ALLEGRO BUS[®]

TIFFIN MOTORHOMES



TIFFIN MOTORHOMES
WHEREVER YOU GO, WE GO.



2012 ALLEGRO BUS

HOME SWEET MOTOR HOME. Make yourself at home in the 2012 Allegro Bus from Tiffin Motorhomes. Built with full-time RVers in mind, this luxurious coach has it all—all the practical amenities you want and exquisite design details you'll appreciate. Prepare to be impressed with the storage capacity, too. Not only does our full pass-thru basement have up to 180 cubic feet of space, but this coach also includes more built-in cabinets than most, all handmade in Red Bay, Alabama. In fact, Tiffin's superior craftsmanship is integrated throughout. We build all the floors, including our elegant ceramic tile, as well as manufacture the custom double-paned windows that provide a quieter ride. The full-body paint on the exterior is the same as that used on luxury automobiles, protected with clear coat to seal the finish. The Bus also gets high marks for safety, with a steel and aluminum structure, two-stage compression engine brake, and up to six air bags. And a surround sound home theater system and four TVs come standard, so deciding who controls the remote will never be a problem.

Luxury for easy living.

Your home is a reflection of who you are, and the Allegro Bus gives you room to express yourself brilliantly. With five floor plans, there's sure to be one that suits your lifestyle. Ranging from 36 to 43 feet long, all floor plans feature four slides and seven-foot ceilings that maximize space and bring a gracious elegance to living areas. Add personal flair with your favorite interior color palette. Expanded for 2012 to include three new schemes, Tour de France, Milan and Lauren, a palette inspired by Ralph Lauren fabrics, these selections join our 2011 bestseller, Creme Brulée. The kitchen is as sophisticated as it is practical. Equipped with a double bowl sink, residential refrigerator, and optional dishwasher, every square inch has been utilized, simplifying food prep, cooking, and storage. For extra counter space, just pull out the Expand-an-island and you're ready to host a holiday buffet.



43 QGP Floor Plan/Tour de France Interior with Glazed Honey Cabinets



OPTIONAL FREESTANDING DINETTE WITH COMPUTER WORKSTATION

With spacious windows in the dining area, breakfast, lunch, and dinner can all be served with your choice of scenery.



KITCHEN
Whether slicing, dicing, cooking, or cleaning, the Allegro Bus offers a well-equipped kitchen space to keep everyone well fed.



Serene solitude.

Your personal sanctuary awaits in your well-appointed master bedroom with optional king-sized bed and adjoining private bath, an amenity available on the bath-and-a-half floor plans. Private areas stay off-limits, as guests can access the convenient powder room in the living area. The living area also features two sofas that pull out to create cozy sleeping quarters. An optional combo or stacked washer/dryer makes a handy addition, as does the standard vacuum system for quick cleaning. The Allegro Bus outdoes the competition with storage space, providing overhead cabinets, an under bed compartment, a sizeable closet, and a full, open basement. Six cabinet options and four neutral color schemes let you personalize the space to truly make it your very own.

WASHER/DRYER

You can't beat the convenience of an onboard optional combo or stacked washer/dryer. Tiffin chooses its appliances to meet the highest performance standards.



43 QGP Floor Plan/Tour de France Interior with Glazed Honey Cabinets



BEDROOM STORAGE

His, hers, and ours. Keep family belongings organized with storage aplenty, from overhead cabinets and multiple drawers to a sizeable closet and an under bed compartment.

MASTER BATH

Not many hotel bathrooms can compete with the luxury you'll find in the Allegro Bus master bath or with its spa-inspired shower stall.



Worthy of center stage.

The Allegro Bus handles with ease, offering a maneuverability you'll appreciate with every turn. A color rear vision monitor system and side cameras keep surrounding areas in view, adding extra safety on the road and in parking areas. Keep your journey safely on course with the optional satellite radio and navigation system. Two chassis are available for the Bus, both featuring a 450-horsepower Cummins® engine and independent front suspension – one from Freightliner® and the other, Tiffin's own PowerGlide® chassis, engineered to our specifications and backed with the best customer service in the industry. Feel the engine's power with a 10,000-pound towing capacity that easily pulls a car or boat. You'll enjoy an easier ride with our newly redesigned driver and passenger seats that add comfort to every mile.



Cockpit with Color Rear Vision Monitor and Power Ultra Leather Seats

NAVIGATION SYSTEM

No need to stop and ask for directions. Your trip stays right on course, thanks to an optional state-of-the-art system that guides you every mile of the way.



SLIDING STORAGE

There's no need to crawl in this crawl space. These optional sturdy slide trays easily extend to provide quick access to stored items.



EXTERIOR ENTERTAINMENT CENTER

Catch your favorite programs wherever you are, inside and out. A specially-designed sound amplification bar beneath the TV provides needed volume.

Ready to go the distance. Engineered and manufactured at our plant in Red Bay, Alabama, the PowerGlide® chassis gives customers the option of having the Tiffin name on their coach from the ground up. Built with top-of-the-line parts, this chassis delivers reliability and value. We exclusively use huck bolts and grade 8 fasteners on the frame, the same as those used on heavy trucks, and the entire electrical system is multiplexed to reduce complexity. As with every Tiffin, it's backed by the industry's best customer service and warranty.



The PowerGlide® Custom Chassis

- | | | | |
|---|--|---|--|
| 1 Aluminum side radiator with integral A/C condenser & charge air cooler | 3 Parallelogram rear suspension with custom-tuned shocks | 6 150 gallon dual fill fuel tank | 9 Tilt-and-telescoping steering column |
| 2 Cummins ISL diesel engine 450 HP/1250 Lb. torque with compression brake | 4 Allison® 3000 MH 6-speed transmission | 7 Independent front suspension with custom-tuned shocks & 17" air disc brakes | 10 18" VIP Smart Wheel |
| | 5 Integrated anti-camber rails for additional strength | 8 295/80R Michelin® all steel radials with polished aluminum wheels | 11 Adjustable pedals |
| | | | 12 Multiplexed electrical wiring system with auto reset fuses & relays |

Interior Décor

As attractive as Tiffin coaches are on the outside, the interior is where we excel. And the Allegro Bus is no exception. Our interior designers have put together a selection of rich color schemes to suit many decorating styles. Each option beautifully complements the tones found in the decorative accents and hardwood cabinetry handcrafted in our Red Bay mill shop and will certainly enhance your personal decorative touches.

Cabinets



Cherry Wood



Natural Cherry



Glazed Cordovan



Glazed Cherry



Glazed Honey



White Chocolate (Bath)*

Flooring



Carpet



Tile

Crème Brulée Fabric Suite



Sofa

Accent

Dinette



Countertop

BEDROOM



Main

Accent

Tour de France Fabric Suite

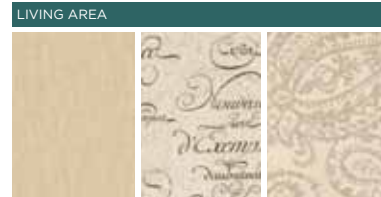

Sofa

Accent

Dinette



Countertop

BEDROOM



Main

Accent

Milan Fabric Suite

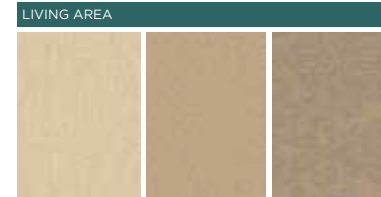

Sofa

Accent

Dinette



Countertop

BEDROOM



Main

Accent

Lauren Fabric Suite Fabrics by Ralph Lauren



Sofa

Accent

Dinette



Countertop

BEDROOM



Main

Accent

*Available only with Glazed Cherry, Glazed Honey, or Glazed Cordovan.

Allegro Bus cabinet doors are made of solid wood, and all cabinet finishes are available in combination with any fabric suite. All options may not be available in every model. Because of progressive improvements, specifications, standard & optional equipment are subject to change without notice or obligation. For a complete and up-to-date list of available options and specifications, visit tiffinmotorhomes.com



Gold Coral



Silver Sand



Maroon Coral



Sunlit Sand



Rustic Canyon



Rocky Mountain Brown

Full-body Paint Schemes

Full-body paint is standard on the 2012 Allegro Bus, as is the protective film that seals in the paint to help retain the fresh-painted shine. Tiffin's paint facility is one of the largest in the country and features a state-of-the-art air filtration system that ensures an impeccable finish. Quality control checks are integrated into the painting process. Meticulous attention is given to every single inch of the Allegro Bus to produce the most precise application.

Floor Plans* & Options

There's an Allegro Bus floor plan perfect for how you live. That's because all Tiffin floor plans are based on ideas and recommendations from customers like you, folks who share your lifestyle needs. We actively survey owners for their suggestions on modifications that can help improve the flow and functionality of our layouts. Our engineers utilize every single inch of each plan, giving you room to roam on the inside while you roam on the outside.

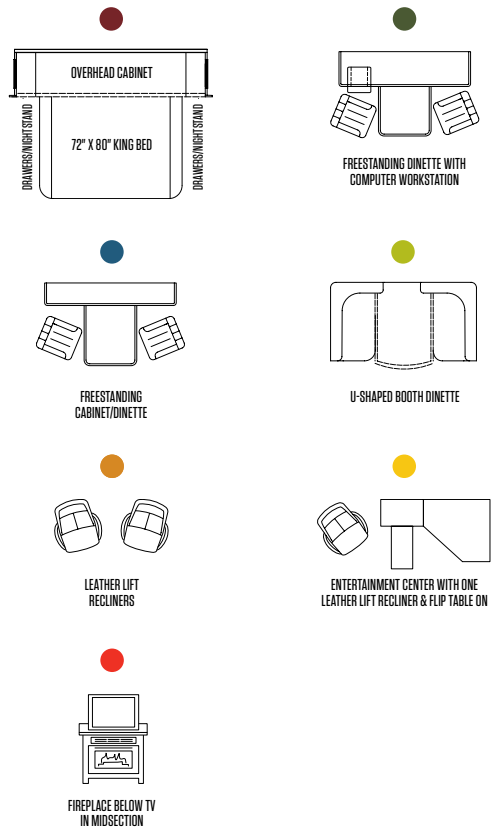

36 QSP

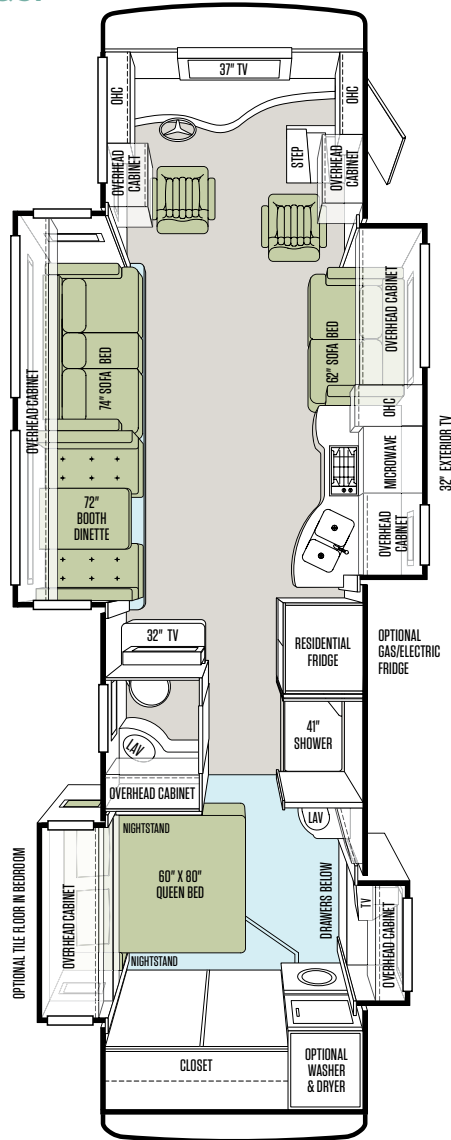

40 QBP

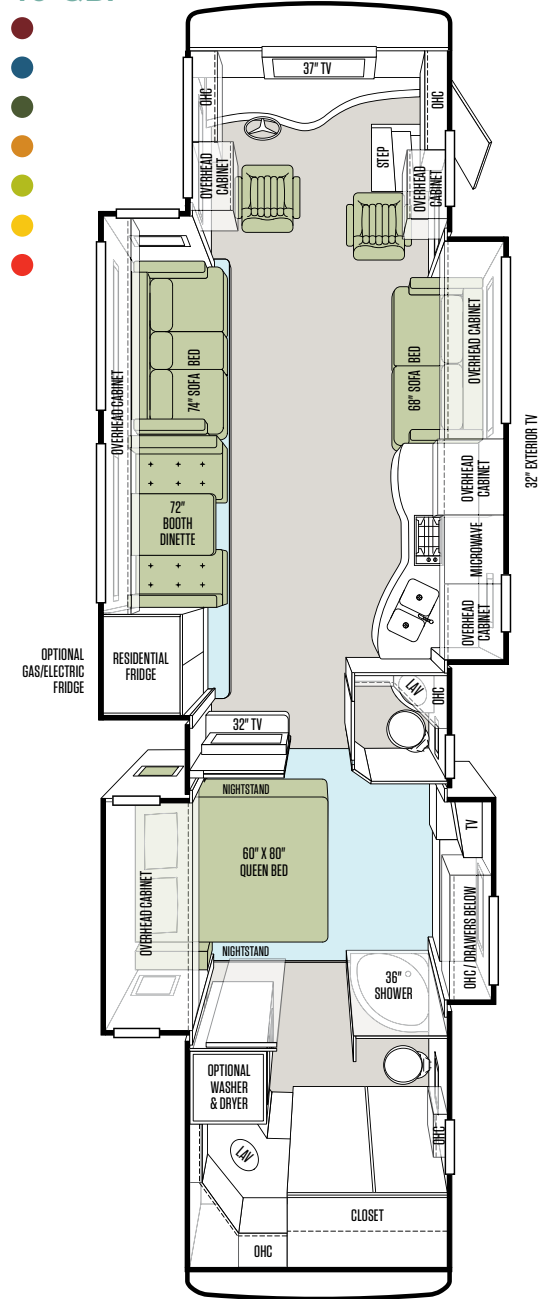

*Additional floor plans may be added throughout the model year. For a complete and current list of available floor plans and options, visit us online at tiffinmotorhomes.com

40 QXP

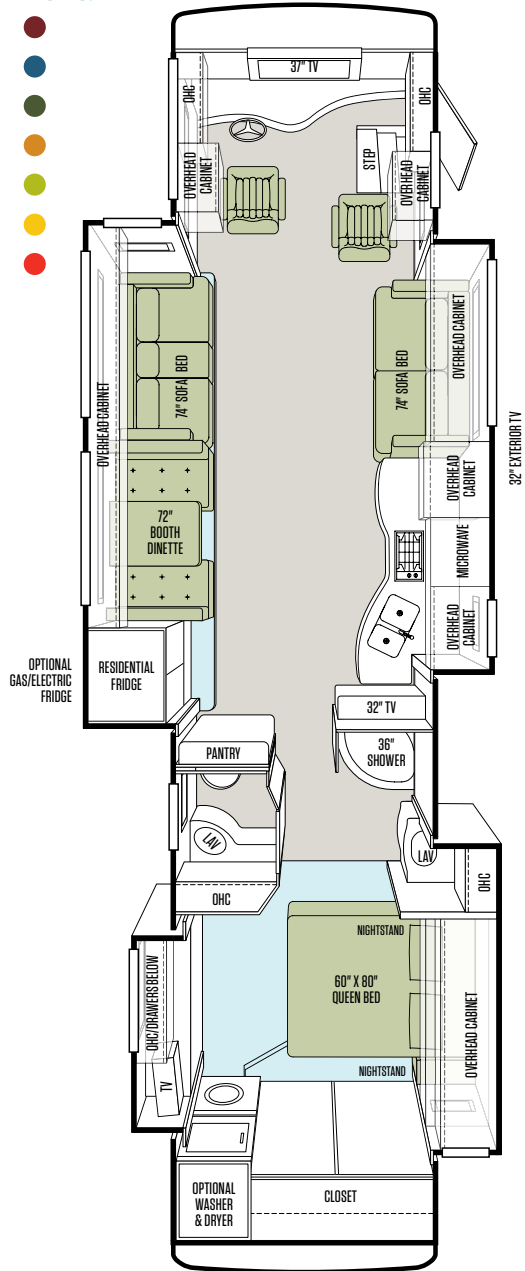

43 QGP

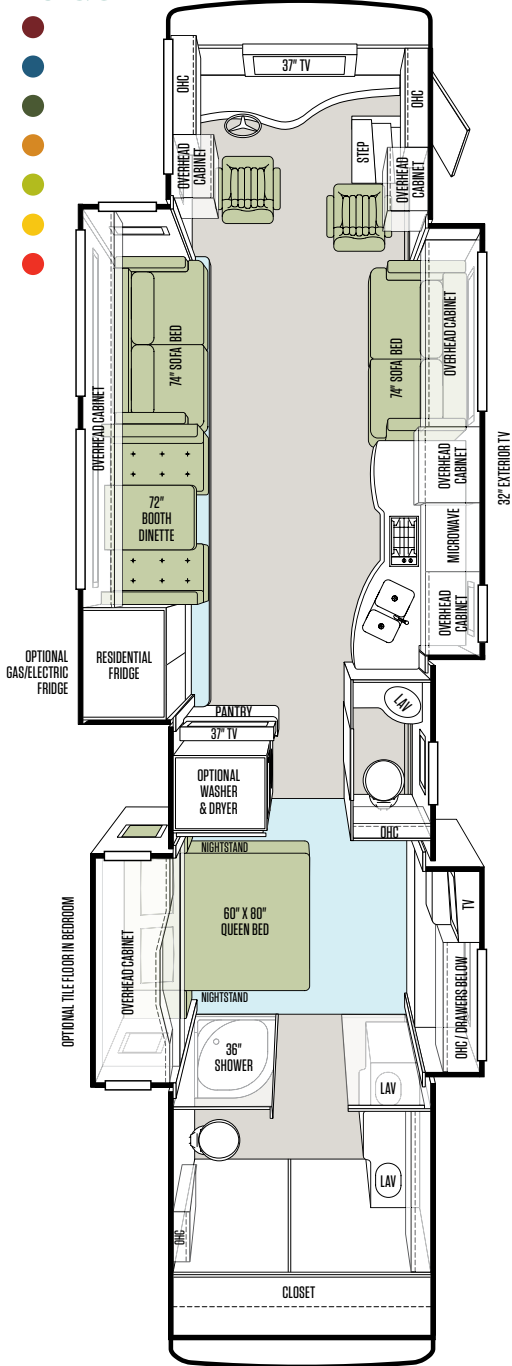

43 QRP

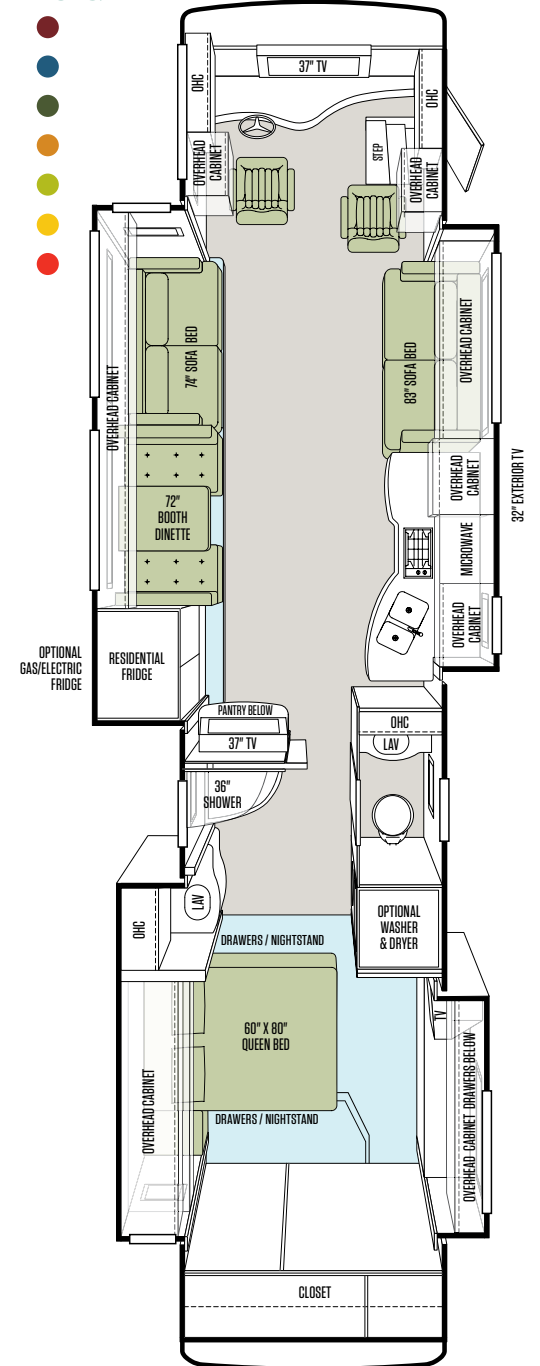

Specifications

Automotive

STANDARD ON ALL MODELS:

- Allison 3000 MH 6-speed Automatic Transmission with Lock-up (Torque Converter)
- Side Mounted Radiator
- ABS Brakes & Two-Stage Compression Engine Brake
- Aluminum Wheels
- Air Bags: 4 on 36' & 40'; 6 on 43'
- Cruise Control
- VIP Smart Wheel
- Fog Lights
- Emergency Start Switch
- Adjustable Gas & Brake Pedals
- Independent Front Suspension

Chassis Options

FREIGHTLINER CHASSIS:	36 QSP	40 QBP	40 QXP	43 QGP	43 QRP
Cummins ISL 450 HP/1250 Lb. Torque	NA	S	S	S	S
GVWR	NA	35,600 Lb.	35,600 Lb.	45,600 Lb.	45,600 Lb.
GAWR—Front	NA	15,600 Lb.	15,600 Lb.	15,600 Lb.	15,600 Lb.
GAWR—Rear	NA	20,000 Lb.	20,000 Lb.	20,000 Lb.	20,000 Lb.
GAWR—Tag Axle	NA	NA	NA	10,000 Lb.	10,000 Lb.
GCWR	NA	45,600 Lb.	45,600 Lb.	55,600 Lb.	55,600 Lb.
Alternator Amps	NA	160	160	160	160
Trailer Hitch Capacity	NA	10,000 Lb.	10,000 Lb.	10,000 Lb.	10,000 Lb.
Fuel Tank (Gallons)—Dual Fuel Fill	NA	150	150	150	150
DEF Tank* (Gallons)	NA	13	13	13	13

POWERGLIDE® CHASSIS:	36 QSP	40 QBP	40 QXP	43 QGP	43 QRP
Cummins ISL 450 HP/1250 Lb. Torque	S	S	S	S	S
GVWR	37,600 Lb.	37,600 Lb.	37,600 Lb.	50,900 Lb.	50,900 Lb.
GAWR—Front	15,600 Lb.	15,600 Lb.	15,600 Lb.	15,600 Lb.	15,600 Lb.
GAWR—Rear	22,000 Lb.	22,000 Lb.	22,000 Lb.	22,000 Lb.	22,000 Lb.
GAWR—Tag Axle	NA	NA	NA	13,300 Lb.	13,300 Lb.
GCWR	47,600 Lb.	47,600 Lb.	47,600 Lb.	60,900 Lb.	60,900 Lb.
Alternator Amps	170	170	170	170	170
Trailer Hitch Capacity	10,000 Lb.	10,000 Lb.	10,000 Lb.	10,000 Lb.	10,000 Lb.
Fuel Tank (Gallons)—Dual Fuel Fill	150	150	150	150	150
DEF Tank* (Gallons)	15	15	15	15	15

Weights & Measures

OVERALL:	36 QSP	40 QBP	40 QXP	43 QGP	43 QRP
Overall Length (Approximate)	36' 11"	40' 4"	40' 4"	43' 6"	43' 6"
Overall Height with Roof Air (Maximum)	12' 7"	12' 7"	12' 7"	12' 7"	12' 7"
Interior Height	84"	84"	84"	84"	84"
Overall Width	101"	101"	101"	101"	101"
Interior Width	96"	96"	96"	96"	96"
Fresh Water (Gallons)	90	90	90	90	90
Black Water (Gallons)	50	50	50	50	50
Grey Water (Gallons)	70	70	70	70	70
LPG Tank (Gallons; can only be filled to 80% capacity)	35	35	35	24	24
Basement Storage (Cubic Feet - Approximate)	122	177	177	180	180
Wheel Base	238"	276"	276"	294"	294"
Tire Size	295/80R	295/80R	295/80R	295/80R	295/80R
Minimum Garage Height	13'	13'	13'	13'	13'

*Diesel Exhaust Fluid (DEF) is the active component used in Selective Catalytic Reduction (SCR) engines to reduce nitrogen oxide emissions by 90% to meet EPA standards.

All options may not be available in every model. Because of progressive improvements, specifications, standard & optional equipment are subject to change without notice or obligation. For a complete and up-to-date list of available options and specifications, visit tiffinmotorhomes.com

Exterior

STANDARD ON ALL MODELS:

- Fiberglass Front & Rear Caps
- Dual Fuel Fills
- BASF Full-body Paint with Protective Film on Front Cap
- Large Tinted One-piece Windshield
- Heated Chrome Power Mirrors with Remote Adjustments
- Single Motor Intermittent Wipers
- Undercoating
- Deadbolt Front Entrance Door
- Keyless Entry Door System & Keyless Component Door Locks
- Exterior TV with Sound Bar
- Hydraulic Automatic Leveling Jacks
- Dual Pane Tinted Windows
- Automatic Door & Patio Awnings
- Window Awning Package
- Slide-out Awnings with Metal-wrapped Covers
- Pass-thru Basement Storage
- Lockable Swing-out Exterior Storage Doors with Gas Shocks
- Heated Water & Holding Tank Compartments
- Auto Generator Start
- Tank Monitor Pad Located at Dump Station
- SeeLevel Tank Monitor
- Six House Batteries
- Custom Mud Flap
- 50 Amp Service
- Power Cord Reel—50 Amp
- Park Telephone & Cable Ready
- Black Holding Tank Flush System
- 110 V Exterior Receptacle
- Water Filter
- Gravity Water Fill
- Docking Lights
- Spotlight with Remote
- Exterior Rinse Hose with Soap Dispenser & Paper Towel Holder
- Concealed Air Horn
- Low Profile In-motion Satellite Dish
NOTE: High-definition programming is not available on a domed satellite antenna unless you subscribe to DISH Network®
- Digital TV Antenna
- Roof Ladder
- Quiet A/C Roof-ducted System
- Luggage Compartment Lights
- Magnum Sine Wave Inverter

AVAILABLE OPTIONS:	36 QSP	40 QBP	40 QXP	43 QGP	43 QRP
One Storage Compartment Slide-out Tray	O	O	O	O	O
Two Storage Compartment Slide-out Trays	NA	O	O	O	O
Onan® 8,000 KW Generator with Two Low Profile Roof Air Conditioners with Heat Pumps	S	S	S	NA	NA
Onan® 10,000 KW Generator with Three Low Profile Roof Air Conditioners with Heat Pumps	NA	O	O	S	S
Paramount Awning with Concealed Roof A/Cs & Antenna	NA	NA	NA	O	O
Two Paramount Awnings with Concealed Roof A/Cs & Antenna	NA	NA	NA	O	O
125 Watt Solar Panel	O	O	O	O	O
Prewired for Winegard Traveler Satellite	O	O	O	O	O
Basement Freezer/Refrigerator (Available Only with All Electric Option)	O	O	O	O	O

Cockpit

STANDARD ON ALL MODELS:

- 37" Front Overhead TV
- 12 V Disconnect Switch
- Driver Side Power Window
- Adjustable Seatbelt Brackets
- 18" VIP Smart Steering Wheel
- Power Ultra Leather Driver & Passenger Seats with Passenger Power Footrest
- Passenger Seat Console Box with Built-in Magazine Rack
- Color Rear Vision Monitor System with Side-view Cameras Activated by Turn Signals
- Contemporary Wraparound Dash with Glare Reduction
- 12 V/110 V Phone Jack Receptacle
- Power Solar/Privacy Windshield Shade
- CD Player & AM/FM Stereo
- Computer Drawer on Passenger Side with Lock-out Rails
- Drawer in Stepwell
- Lighted Switches
- Dual Dash Fans
- Fire Extinguisher
- Beverage Tray

AVAILABLE OPTIONS:	36 QSP	40 QBP	40 QXP	43 QGP	43 QRP
Satellite-ready Radio (Requires Subscription)	O	O	O	O	O
In-dash Stereo/Navigational System	O	O	O	O	O
Rearview Mirror with Compass & Outside Temperature	O	O	O	O	O

Living Area/Dinette

STANDARD ON ALL MODELS:

- Ultra Leather DE Sofa/Sleeper on Passenger Side
- Cloth DE Sofa/Sleeper on Driver Side
- 12 V Receptacle & Phone Jack at Dinette
- Full Ceramic Tile Floor in Living Room & Bath
- Booth Dinette with Solid Surface Table

AVAILABLE OPTIONS:	36 QSP	40 QBP	40 QXP	43 QGP	43 QRP
Freestanding Dinette with Computer Workstation	O	O	O	O	O
Freestanding Dinette with Built-in Cabinets	O	O	O	O	O
Cloth DE Sofa/Sleeper on Passenger Side	O	O	O	O	O
Ultra Leather Air Coil Hide-A-Bed Sofa/Sleeper on Passenger Side	NA	O	O	O	O
Cloth Air Coil Hide-A-Bed Sofa/Sleeper on Passenger Side	NA	O	O	O	O
Ultra Leather DE Sofa/Sleeper on Driver Side	O	O	O	O	O
Cloth DE Sofa/Sleeper on Driver Side	O	O	O	O	O
Ultra Leather Air Coil Hide-A-Bed Sofa/Sleeper on Driver Side	O	NA	NA	NA	NA
Cloth Air Coil Hide-A-Bed Sofa/Sleeper on Driver Side	O	NA	NA	NA	NA
Ultra Leather Magic Bed on Driver Side	O	O	O	O	O
Cloth Magic Bed on Driver Side	O	O	O	O	O
Combo Sofa/Booth Dinette—Cloth—on Driver Side	O	O	O	O	O
Combo Sofa/Booth Dinette—Ultra Leather—on Driver Side	O	O	O	O	O
Leather Lift Recliners (2) on Driver Side	O	O	O	O	O
Entertainment Center with One Leather Lift Recliner & Flip Table on Driver Side	NA	O	O	O	O
Fireplace Below TV	NA	O	O	O	O

Specifications

Kitchen

STANDARD EQUIPMENT ON ALL MODELS:

- Polished Solid Surface Countertops with Sink & Stove Covers
- Expand-an-island
- 2 1/2" Deep Lighted Toe Kick
- Single Lever Sink Faucet with Built-in Sprayer
- Residential Double Bowl Stainless Steel Sink
- LED Light Above Countertop
- Residential Stainless Steel Refrigerator with Icemaker (6 batteries)
- Galley Soap Dispenser
- Stainless Steel Convection Microwave with Exterior Venting
- 2-burner Glass Cooktop

AVAILABLE OPTIONS:	36 QSP	40 QBP	40 QXP	43 QGP	43 QRP
3-burner Cooktop with Gas Oven (NA with Dishwasher)	O	O	O	O	O
Dishwasher (Drawer Type)	O	O	O	O	O
Gas/Electric Refrigerator (4 Batteries; NA with All Electric Coach)	O	O	O	O	O

Bath

STANDARD EQUIPMENT ON ALL MODELS:

- Medicine Cabinet with Vanity Lights
- Solid Surface Vanity Top & Bowl
- Skylight in Shower with Sliding Cover
- 3-speed Fantastic® Fan
- Electric Flush Toilet

AVAILABLE OPTIONS:	36 QSP	40 QBP	40 QXP	43 QGP	43 QRP
41" Molded Fiberglass Shower	S	NA	NA	NA	NA
36" Molded Fiberglass Shower with Radius Door	NA	S	S	S	S
Hydronic Heating System (Required on All Electric Coach)	O	O	O	S	S
Tankless Gas Water Heater (NA with All Electric Coach)	O	O	O	NA	NA

Bedroom

STANDARD EQUIPMENT ON ALL MODELS:

- Innerspring Queen Mattress (60" x 80")
- Bed Comforter with Throw Pillows
- Ceiling Fan
- TV Prewired for DVD & Satellite Receiver
- Solid Surface Nightstand Tops
- Solar/Privacy Shades
- Wardrobe with Automatic Light
- Laundry Hamper

AVAILABLE OPTIONS:	36 QSP	40 QBP	40 QXP	43 QGP	43 QRP
King Bed Mattress (72" x 80")	NA	O	O	O	O
Dual Control Bed System—Queen (60" x 80")	O	O	O	O	O
Dual Control Bed System—King (72" x 80")	NA	O	O	O	O
Memory Foam Queen Mattress (60" x 80")	O	O	O	O	O
Memory Foam King Mattress (72" x 80")	NA	O	O	O	O
Tile Flooring in Bedroom	O	NA	NA	O	NA
Security Safe	O	O	O	O	O

Interior

STANDARD EQUIPMENT ON ALL MODELS:

- 7" Ceilings with LED Bullet Lights
- Soft Touch Vinyl Ceilings
- High Gloss Raised Panel Cabinet Doors
- Air Driven Step Well Cover
- Washer/Dryer Ready
- SeeLeveL Tank Monitor
- Carbon Monoxide, LP & Smoke Detectors
- Central Vacuum Cleaner with VacPan
- Ceramic Tile Flooring in Kitchen, Bath, Entrance Landing & Living Room
- Complete Cable Wiring Interfacing with Surround Sound & Satellite Receiver
- Multiplex Lighting System
- Enclosed Surround Sound Speakers
- Energy Management System
- Power Solar/Privacy Shades

AVAILABLE OPTIONS:	36 QSP	40 QBP	40 QXP	43 QGP	43 QRP
Combo Washer/Dryer with Overhead Storage Area	O	O	O	O	O
Stacked Washer/Dryer	O	O	O	O	O
10-gallon DSI Gas/Electric Water Heater	S	S	S	NA	NA
Two 30,000 BTU Ducted Furnaces	S	S	S	NA	NA
All Electric Coach with Induction 2-burner Cooktop	O	O	O	O	O
32" TV/Entertainment Center	S	S	S	NA	NA
37" TV/Entertainment Center	NA	NA	NA	S	S

Structural/Construction

STANDARD ON ALL MODELS:

• Laminated Floor, Sidewall & Roof

• Steel/Aluminum Reinforced Structure

• One-piece Molded Fiberglass Roof Cap

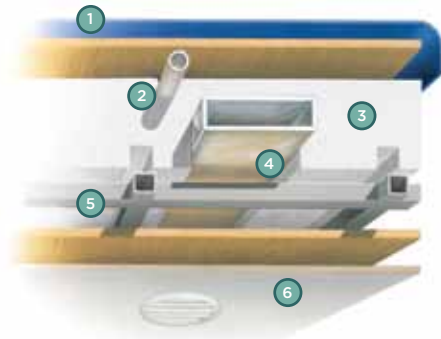

Roof

- 1 One-piece, moisture resistant molded fiberglass roof cap provides insulation and strength and prevents water intrusion
- 2 A/C Condensation Drainage System that runs internally through the roof insulation and down the sidewalls, redirecting water underneath the motor home
- 3 5 1/2" formed insulation
- 4 Quiet Air Cooling System with return air and foil-wrapped cooling exhaust ducts
- 5 Durable, tubular aluminum roof skeleton
- 6 Easy-to-clean soft touch vinyl ceiling panel

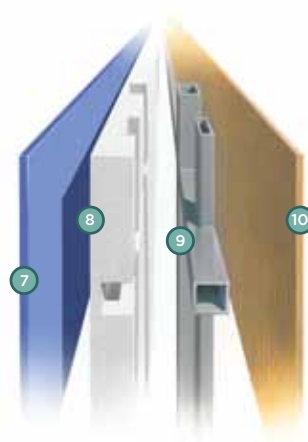

Sidewall*

- 7 Gel-coat fiberglass outside wall panel
- 8 High performance thermal insulation
- 9 Durable, yet lightweight, tubular aluminum wall skeleton
- 10 Decorative inside wall panel

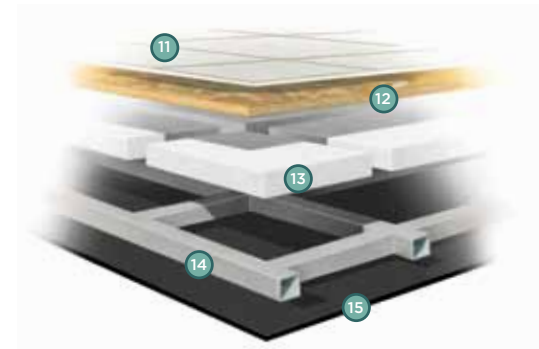

Floor

- 11 Ceramic tile floor bonded to high-impact oriented strand board
- 12 High-level engineered oriented strand board
- 13 High-performance thermal insulation
- 14 Durable, tubular floor skeleton
- 15 Woven moisture barrier material

*All sidewalls are approximately 2" thick.

All options may not be available in every model. Because of progressive improvements, specifications, standard & optional equipment are subject to change without notice or obligation. For a complete and up-to-date list of available options and specifications, visit tiffinmotorhomes.com

Why buy a Tiffin Motorhome?

Every company under the sun talks about quality. For some, that's all it is—talk. Unlike our competitors, Tiffin Motorhomes produces many of our own parts. Not only does this give us complete control over quality, it enables us to later provide replacement parts for older models. That means, on a Tiffin coach, Tiffin craftsmen also manufactured the windows, moldings, fiberglass, textiles, finishes, millwork, custom cabinetry, and, on some models, the chassis. Building the best motor homes in the industry is our goal, and keeping a close eye on quality is always one way you can count on us to deliver.

10-YEAR LIMITED FRAME WARRANTY

We warranty the frame of the walls, floors, and roof for 10 years.

5-YEAR LIMITED SIDEWALL BOND WARRANTY

We warranty the sidewall against delamination between the outside fiberglass and the inner frame for 5 years.

tiffinmotorhomes.com

Visit us on the web for more information on the 2012 Allegro Bus and all of our 2012 Tiffin Motorhomes, as well as the latest product and specification updates. Plus, watch videos and see other exclusive web content.

FOR PARTS & SERVICE CALL 256/356.0261

YOUR LOCAL TIFFIN DEALER:



This year, Tiffin Motorhomes proudly celebrates our 40th year of building the finest motor homes on the road. What an amazing ride we've had—and are still having. Thanks to everyone who has been a part of our journey, from our dedicated team to our wonderful customers. We sure couldn't have done it without you. Fasten your seatbelts, everybody, and let's get going to make it another 40 years!

Safe travels,

Bob Tiffin

President/Founder

