



COMMERCIAL PRODUCTS



ARE



WHY BUY A.R.E.?



UNMATCHED SERVICE:

Industry leading support from over 700 dealers & partners throughout the US and Canada.



BUY WITH CONFIDENCE:

Limited lifetime warranty on all fiberglass caps and covers.



MADE IN THE USA:

Every order is custom built right here in the US.



INNOVATION LEADERS:

Our focus is to live outside the industry norm – designing and developing the most advanced products.



ISO CERTIFIED:

We are the first and only ISO certified truck cap and cover manufacturer in the US.



OUTFIT TO LAST

For 50 years we have been covering truck beds with the most innovative, highest quality caps and covers built in the heartland of America: Northeast Ohio. We know you love your truck, which is why our passion is to manufacture the perfect companion for your truck, backed by the industries best support and warranty. Take a look around, we believe you'll see exactly what you need to outfit your truck for life.

COMMERCIAL ALUMINUM	4
HD	11
TOOLMASTER	14
DOUBLECOVER	18
FUSION	19
3DL	20
LSII	21
ADDITIONAL ACCESSORIES	22



GET TO WORK WITH A COMMERCIAL ALUMINUM CAP

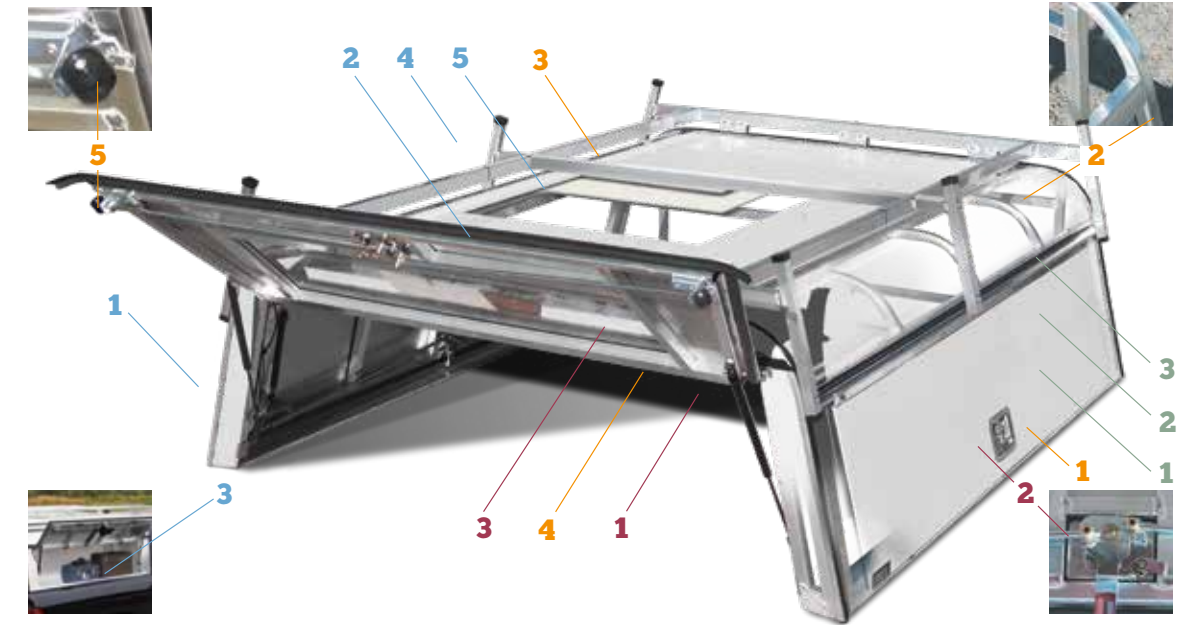

THE RIGHT TOOL FOR YOUR TRUCK

A.R.E.'s rugged welded frame construction offers years of durable service, no matter what the weather or job. Each unit has weather-sealed doors with gas props, heavy-duty hinges, and automotive-style locks to protect your valuables.



DCU MAX™



**DCU
DIAMOND EDITION™**

OPTIONS

- 1 Height** – A.R.E. has four standard heights plus three wedge heights to meet your specific capacity needs. (Height and wedge availability varies by model.)
- 2 Rear Doors** – A.R.E. offers many door styles for your rear access needs.
- 3 Side Toolboxes** – Toolboxes are made of .036 galvanized steel with a baked white coat or .063 diamond plate, depending on model. The bins can be customized to include dividers and fold-down shelves.
- 4 Roof Racks** – A.R.E. offers many different racks to meet your specific hauling needs. Extra cross bar supports are available.
- 5 Vapor Barrier Insulation** – Optional dark gray headliner provides protection from condensation.

STRUCTURE

- 1 Baserails** – 0.80" thick T6 aluminum baserails with MIG welded corners provide a strong foundation.
- 2 Structural Tubing** – .050" thick T6 aluminum tubing framework with TIG welded joints provides strength and support with minimal weight.
- 3 Exterior Skin** – .035" (DCU®), .063" (DCU MAX™) or .063" diamond plate (Diamond Edition DCU™) thick aluminum exterior skin for superior structure.
- 4 Door Frames** – A.R.E. builds all styles of doors with the same .050" thick wall tubing used in the body frame. All TIG welded joints and continuous hinges assure alignment and durability.
- 5 Roller Rods** – One-hand operation to provide easy access and improved seal.

FINISH

- 1 Body Colors** – A.R.E. offers our DCU® in white, light gray or black and our DCU MAX™ in white. The color is baked enamel finish applied to the aluminum skin at the mill. The color is not meant to provide a match to any OEM truck paint, but is intended to accent the truck's appearance without the cost of custom painting.
- 2 Custom Axalta® Paint Finishes** – Optional two-stage ChromaPremier® paint is offered in any OEM or fleet color code formula. Applied in our downdraft booths and baked on for durability.
- 3 Trims** – Edge trims are offered in black or white.

COMPONENTS

- 1 Gas Props** – Our gas props are set to the optimal pressure to assist in lifting and closing each cap door.
- 2 Latches and Locks** – The folding T-grip latch handle is durable and offers top security. The cam action deadbolt lock rods with the center point lock provide lifelong trouble-free operation. All latches and locks have 500 hours non-corrosion finish.
- 3 Windows** – A.R.E. offers radius dark tinted tempered safety glass in all doors. Optional heavy aluminum mesh security screens deter unwanted entry.

BUILD YOUR PERFECT ALUMINUM CAP

Follow these 12 steps and check options clearly. Consult your local A.R.E. dealer for more details or with questions regarding any of the options shown here.

1 CHOOSE YOUR MODEL



DCU (.035")

- Strength and durability for everyday use
- Heavy-duty .035" aluminum skin
- Standard 1/2 rear door
- Standard full length side door
- Available in wedge style
- Galvanized steel toolboxes with baked white coating

DCU MAX™



DCU MAX (.063")

- Increased strength and durability for the toughest work environments
- Heavy-duty .063" aluminum skin
- Stainless steel strap hinges on double or single full doors
- Galvanized steel toolboxes with baked white coating

DCU DIAMOND EDITION™



DE Diamond Edition DCU (.063" Diamond Plate)

- Increased strength and durability for the toughest work environments with added style
- Heavy-duty .063" diamond plate aluminum skin
- Stainless steel strap hinges on double or single full doors
- Diamond plate toolboxes

2 CHOOSE A CAP HEIGHT

A. Select the appropriate height for your needs. Consider headroom, accessibility and the amount of overall space you need.

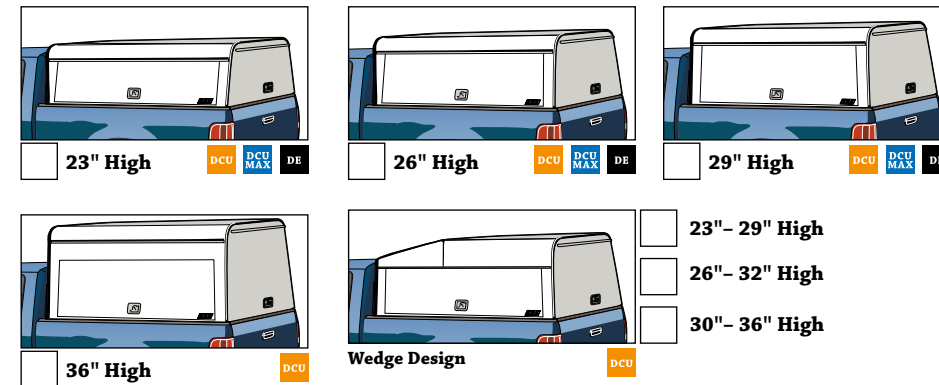

3 CHOOSE A COLOR AND INTERIOR OPTIONS

A. Choose from one of our standard colors or have your cap painted to match the truck manufacturer's paint code.



B. Choose from our interior upgrade options based on your needs for added security, strength or insulation.

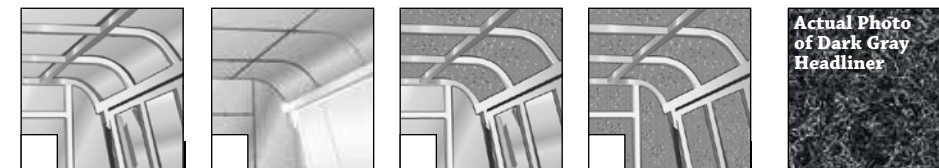

Standard
No Interior Skin

Interior Skin
(.035 Aluminum)
Roof, Front and Back

Dark Gray Headliner
Roof Only

Dark Gray Headliner

C. Choose a roof vent for increased air circulation.

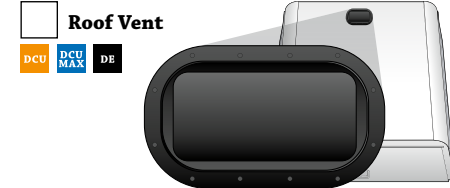

4 CHOOSE A REAR DOOR

A. Choose the rear door and window option that provides optimal accessibility on a daily basis.

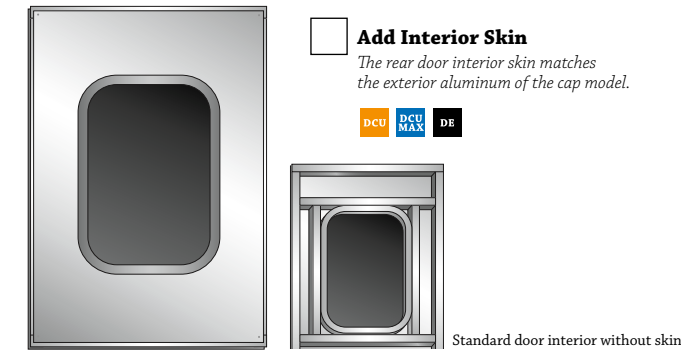
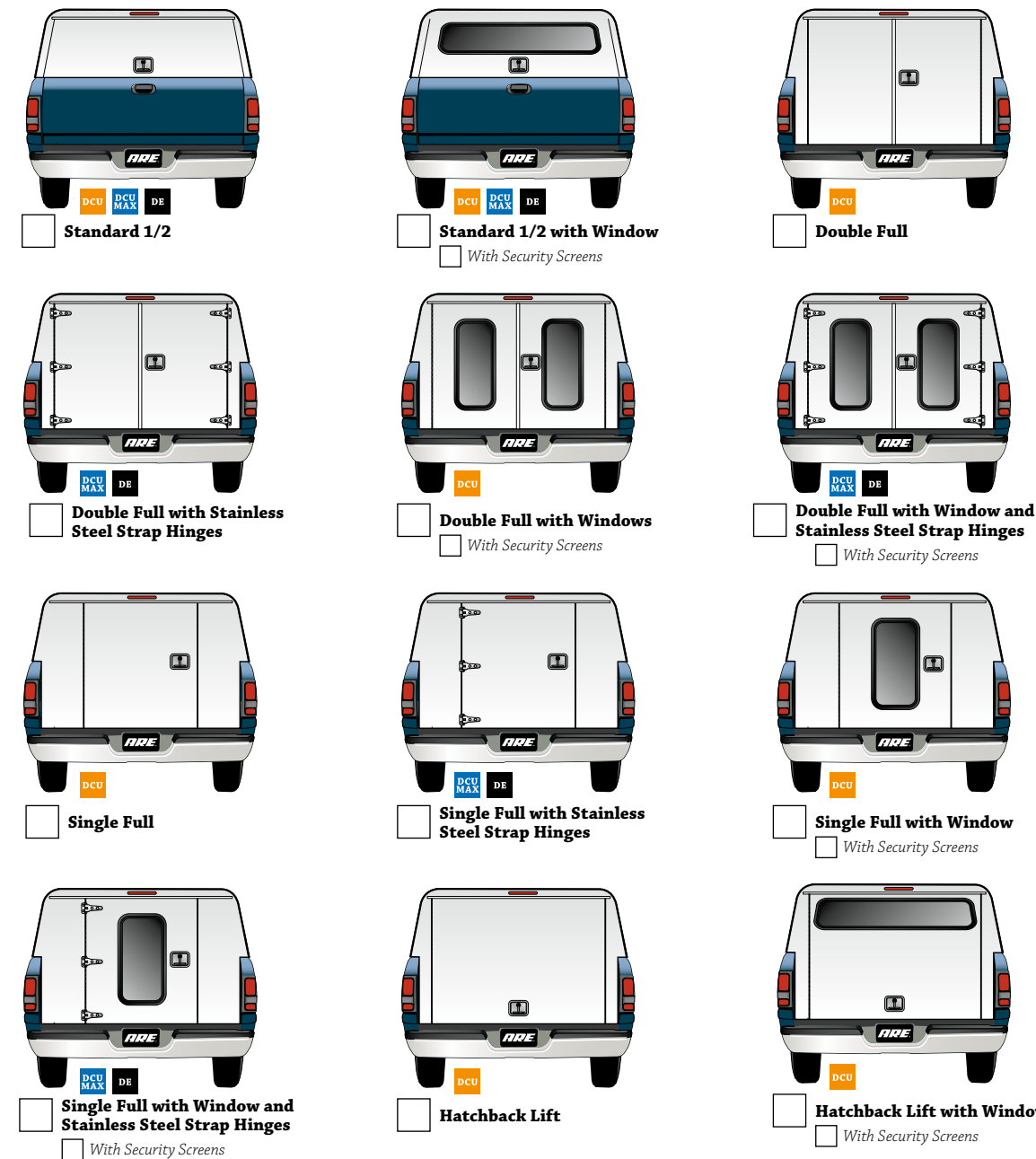

5 CHOOSE A FRONT WINDOW OPTION

A. Choose the front window option based on your security, access and visibility needs.

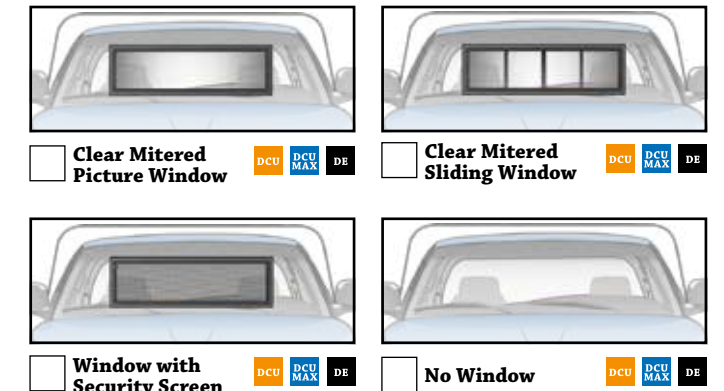

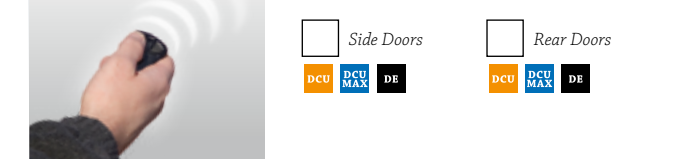

6 KEYLESS ENTRY

A. Utilize your truck's key fob to lock/unlock the cap.

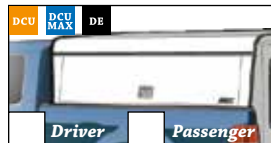
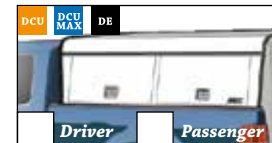
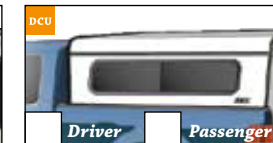
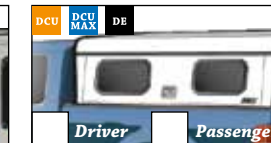

7 CHOOSE A SIDE OPTION

A. Choose the side option that fits your needs for access and visibility. If no selection, sides will be solid.

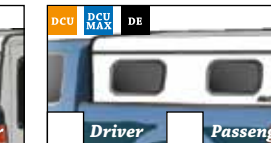
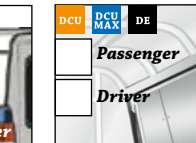
 Standard Full Length	 Double Doors	 Radius Slider	 Full Length with Window <input type="checkbox"/> With Security Screens	 Solid Glass Window	 Two Windows Only	 Interior Skin Interior skin matches the exterior skin of the cap
---	--	---	--	--	--	---



DCU
DELUXE COMMERCIAL UTILITY™



DCU MAX™



DCU
DIAMOND EDITION™

8 CHOOSE A TOOLBOX AND SHELVING OPTIONS

Toolboxes and Shelving Options apply to all Commercial Aluminum Models

A. Choose an easy access opening, standard toolbox, or one of the special bin storage packages from Ranger Design. DCU® and the DCU Max™ have steel interiors, the Diamond Edition has diamond plate. Note: Fabric liner is not available on toolbox interior.

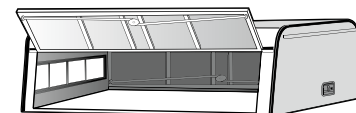
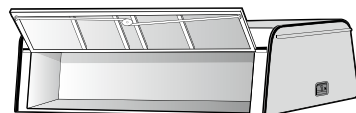
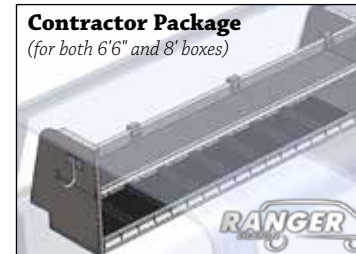
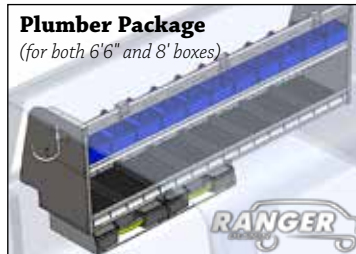
 No Toolbox <input type="checkbox"/> Driver <input type="checkbox"/> Passenger	 Standard Toolbox <input type="checkbox"/> Driver <input type="checkbox"/> Passenger
 Contractor Package (for both 6'6" and 8' boxes) Contractor (Z10-S6 or Z10-S8) <input type="checkbox"/> Driver <input type="checkbox"/> Passenger	 Plumber Package (for both 6'6" and 8' boxes) Plumber (Z15-S6 or Z15-S8) <input type="checkbox"/> Driver <input type="checkbox"/> Passenger

B. Choose one of the 15 toolbox options shown below, a fold-down shelf for use on the job or choose to have no shelves at all.

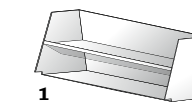
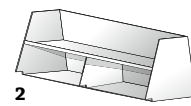
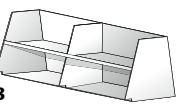
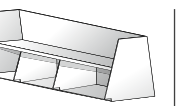
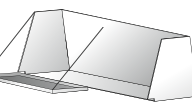
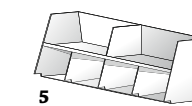
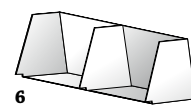
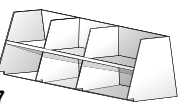
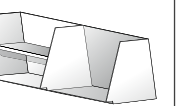
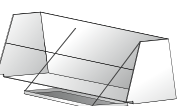
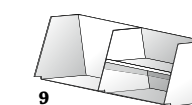
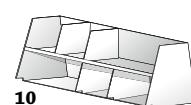
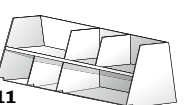
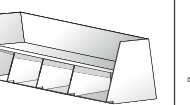
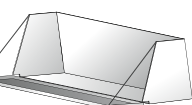
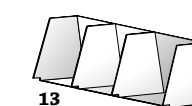
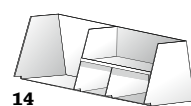
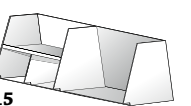
 1	 2	 3	 4	 1 Fold-Down Half Shelf Front
 5	 6	 7	 8	 2 Fold-Down Half Shelf Rear
 9	 10	 11	 12	 3 Fold-Down Full Shelf
 13	 14	 15	Fold-Down Shelving Options Driver Side _____ Passenger Side _____	

9 CHOOSE A LADDER RACK OPTION

Ladder Rack Options apply to all Commercial Aluminum Models

A. Choose an A.R.E. manufactured welded aluminum ladder rack or a commercial-grade aluminum or steel locking ladder rack.

 No Ladder Rack	 Ladder Rack With center support and third leg	 Ladder Rack With two center supports and third leg
--	--	---

KARGO MASTER

KargoMaster
Heavy-Duty Rack System



PRIME DESIGN™

ErgoRack®

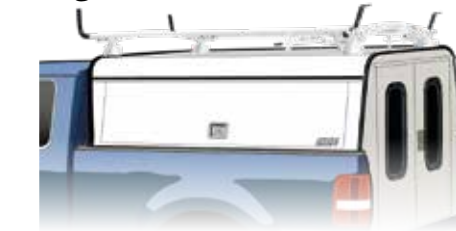

- Double Clamping Double Rotational
- Driver Side Clamp and Passenger Side Rotational Optional Step Ladder Adaptor
Only available for Prime Design models on 8 foot beds.

AluRack®

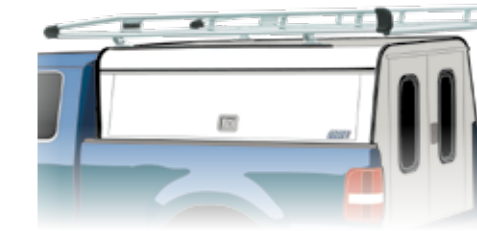

- 80" AluRack® Aluminum Rack System 120" AluRack® Aluminum Rack System
- 98" AluRack® Aluminum Rack System



Easy-Loading Roller System
Allows ergonomic loading and unloading of ladders, reducing stress and injuries. One person can easily load the ladders without damaging the vehicle.









AluRack® Optional Add-On:
Quick Clamp Ladder Lock Attachment
 Driver Passenger

10 INCREASE VISIBILITY AND SAFETY

Lighting options apply to all Commercial Aluminum Models

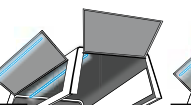

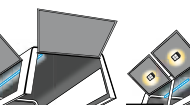

A. Consider where you need light for night visibility, also if you would like the lighting to come on automatically when opening the doors.

Driver's Side Rival LED Lighting Options

 Single Door Rope Light	 Double Doors Rope Lights	 Single Door Rope Light and Auxiliary Rope Light	 Double Doors Rope Lights and Auxiliary Rope Lights	 Single Door Rope Light and Auxiliary Light	 Double Doors Rope Lights and Auxiliary Lights
---	---	--	---	---	--

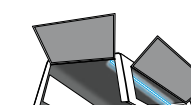
No Driver Side Rope Light Prop Switch at Driver Side Will not operate Auxiliary Lights

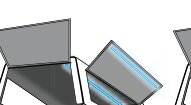
Passenger's Side Rival LED Lighting Options

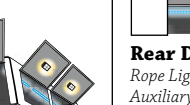
 Single Door Rope Light	 Double Doors Rope Lights	 Single Door Rope Light and Auxiliary Rope Light	 Double Doors Rope Lights and Auxiliary Rope Lights	 Single Door Rope Light and Auxiliary Light	 Double Doors Rope Lights and Auxiliary Lights
---	---	--	---	---	--

No Passenger Side Rope Light Prop Switch at Passenger Side Will not operate Auxiliary Lights

Rear Door Rival LED Lighting Options

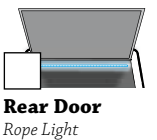

Rear Door
Rope Light

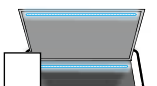

Rear Door
Rope Light and Auxiliary Rope Light

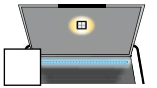

Rear Door
Rope Light and Auxiliary Light



Rear Door
No Rope Light

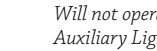

Prop Switch at Rear
Will not operate Auxiliary Lights

11 INCREASE VISIBILITY AND SAFETY WITH OUR BACK-UP CAMERA OPTION

A. This 7" monitor will replace your rear view mirror unless you want to mount it to your dashboard.



Option 1:

Back-up camera with 7" monitor

Option 2:

Back-up camera with 7" monitor and dashboard mount

Option 3:

Back-up camera with wiring harness (uses trucks existing monitor)

DCU DCU MAX DE

12 CHOOSE REAR DOOR SECURITY OPTION

A. By safely securing your vehicle with Slick Locks puck locks in combination with their patented Spinner 360™ and Weather Shield™, you will be fully equipped with the most preferred vehicle locking system on the market today!



Slick Locks

NOTE: For double full rear doors only

DCU DCU MAX DE

COMMERCIAL ALUMINUM CAP WARRANTY

A.R.E. warrants to the original purchaser of Commercial Aluminum truck caps that they are free from defects in structure, materials and workmanship for a period of three years from the date of purchase from an authorized A.R.E. dealership. See the dealership for a copy of the full warranty statement.

Certified System
ISO 9001

200+ POSSIBLE CAP OPTIONS



With 200 or more variations to choose from, you can create the perfect cap to fit your work needs. Our rugged, fully welded frame construction offers years of durable service, no matter what the weather or job. There's a reason that the A.R.E. DCU Series® is the only truck cap that received a 10 out of 10 rating by Handyman Magazine readers.

Commercial Aluminum Options List ✓ = Standard Features • = Optional Features	DCU (.035" Thick)	DCU MAX (.063" Thick)	DIAMOND EDITION (.063" Thick)
Standard Metal Skin Colors	White, Light Gray or Black	White	N/A
Paint-to-match	•	•	N/A
Black or White Trim	✓	✓	✓
Height	23", 26", 29", 36"	23", 26", 29"	23", 26", 29"
Wedge Height	23"-29", 26"-32", 30"-36"	N/A	N/A
Slanted Sides/Slanted Front	✓	✓	✓
Radius Front/90° Side Walls on 29" and 36" units only	•	•	N/A
Dark Gray Headliner	•	•	•
Metal Inner Skin	•	•	•
Double Full Doors	•	•	•
Single Full Door	•	•	•
Full Hatchback Lift Door	•	N/A	N/A
Radius Slider Windows	•	N/A	N/A
Solid Glass Window	•	N/A	N/A
Sliding Front Window	•	•	•
Solid Front Window	•	•	•
Roof Vent	•	•	•
Slick Lock	•	•	•
Security Screens	•	•	•
Full Length Side Door	✓	✓	✓
Double Side Door	•	•	•
Tool Bins	•	•	•
Dividers in Tool Bins	•	•	•
Fold-Down Shelves	•	•	•
Brake Light	✓	✓	✓
12V LED Interior Lights	•	•	•
Prop Switch on Doors	•	•	•
Aluminum Ladder Rack	•	•	•
Prime Design Ladder Rack	•	•	•
KargoMaster Ladder Rack	•	•	•
AluRack® with Easy Loading Roller	•	•	•
CargoGlide® Cargo Access System	•	•	•
TruckVault® Sliding Drawers	•	•	•
Keyless Entry	•	•	•
Back-Up Camera	•	•	•



200 LBS TOOL BOX 550 LBS ROOF RACK

CONTRACTOR-GRADE DURABILITY

There has never been a stronger and more durable fiberglass truck cap than the new A.R.E. HD™. Available for our CX and MX cap profiles, the HD™ features an internal skeleton which triples the weight capacity of the roof rack and side toolboxes. If you test the limits of your truck, and need your cap to be up for the challenge, the A.R.E. HD™ truck cap is the only choice!

OPTIONS

- Available for our CX or MX cap profiles
- Rear Doors – Aluminum paneled door with folding T-handles.
- Side Toolboxes – Diamond plate toolboxes depth 12"–16" depending on truck model (200 lb weight rating per box).
- Roof Racks – 3 different racks to meet your specific hauling needs.

STRUCTURE

- Sandable Primer Gelcoat
- Unique Polyester Resin Fiberglass Laminate
- Low Filled Resin Fiberglass – Resin fiberglass provides a superior structure.

FINISH

- Body Colors – A.R.E. offers our HD cap in any color to match your truck body.
- Clear Coat Exterior – Lasting paint protection.
- Automotive Grade Paint – Two-stage ChromaPremier® paint is offered in any OEM or fleet color code formula.

STRENGTH

- Reinforced Roof
- Extra Reinforcement
- Internal Aluminum Skeleton



BUILD THE CAP

That is Perfect for Your Needs

Follow these 8 steps and check options clearly. **X**

Consult your local A.R.E. dealer for more details or with questions regarding any of the options shown here.

1 CHOOSE A CAP PROFILE

A. Choose the appropriate cap profile for your needs.

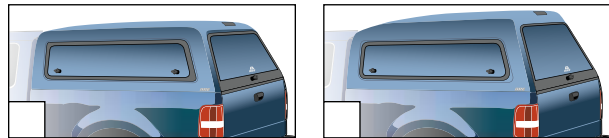

CX MX

3 CHOOSE A FRONT WINDOW OPTION

A. Choose the front window option based on your access and visibility needs.

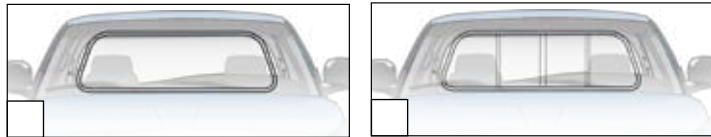

Aluminum Framed Picture Window Aluminum Framed Sliding Window

5 CHOOSE A SIDE WINDOW OPTION

A. Choose the side option that fits your needs for access and visibility.

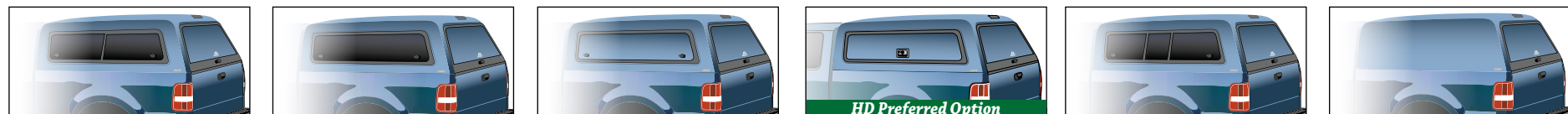

Aluminum Framed Half Slider Glass Window Aluminum Paneled Window Aluminum Paneled Window with Folding T Outdoorsman Vented Window Solid Side Fiberglass

Driver Passenger Driver Passenger Driver Passenger Driver Passenger Driver Passenger Driver Passenger

2 CHOOSE AN INTERIOR FINISH

A. Choose your preference of our two interior options.

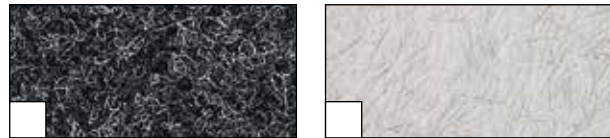

Dark Gray Headliner Fiberglass Finish

4 CHOOSE A REAR DOOR

A. Choose the rear door and window option that provides the optimal accessibility on a daily basis.

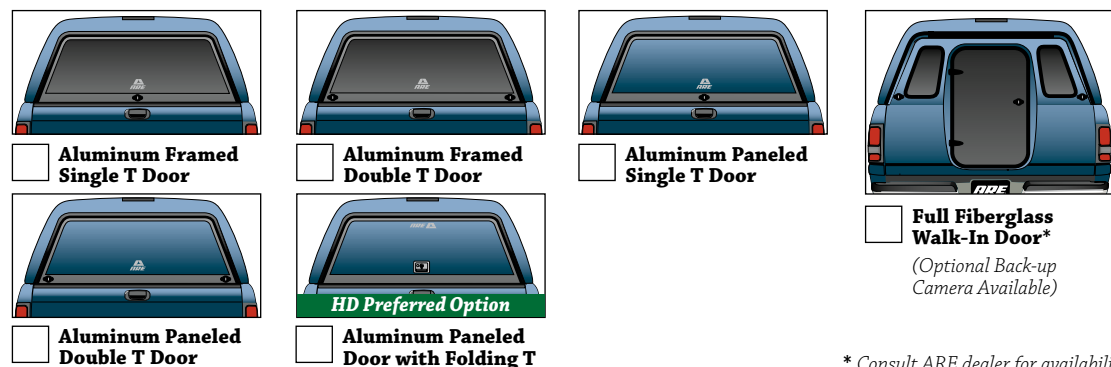

Aluminum Framed Single T Door Aluminum Framed Double T Door Aluminum Paneled Single T Door Full Fiberglass Walk-In Door* (Optional Back-up Camera Available) Aluminum Paneled Double T Door Aluminum Paneled Door with Folding T

* Consult ARE dealer for availability

6 CHOOSE TOOLBOX AND SHELVING OPTIONS

A. Choose to have either diamond plate toolbox options or an easy access opening on either side.

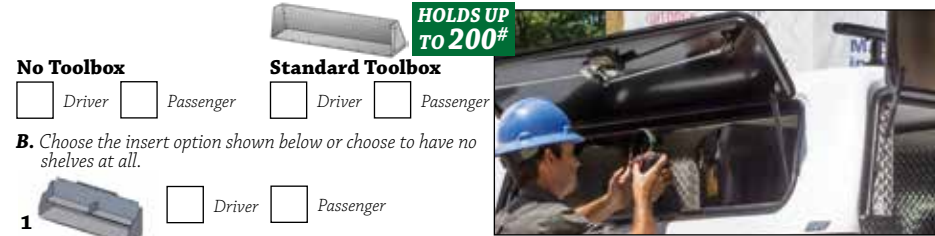

No Toolbox Driver Passenger Standard Toolbox Driver Passenger **HOLDS UP TO 200#**

B. Choose the insert option shown below or choose to have no shelves at all.

1 Driver Passenger

7 CHOOSE A LADDER RACK OPTION

A. Choose a ladder rack that is perfect for your storage needs.

No Ladder Rack



HD Ladder Rack



Universal Mounting Tracks

YAKIMA



Yakima CoreBar Roof Rack (Steel)



Yakima JetStream Roof Rack (Aluminum)

PRIME DESIGN

ErgoRack®



Double Clamping Double Rotational Driver Side Clamp and Passenger Side Rotational

Optional Step Ladder Adaptor
Only available for Prime Design models on 8 foot beds.

AluRack®



80" AluRack Aluminum Rack System 98" AluRack Aluminum Rack System 120" AluRack Aluminum Rack System



AluRack Optional Add-On: Quick Clamp Ladder Lock Attachment Driver Passenger



Easy-Loading Roller System
Allows ergonomic loading and unloading of ladders, reducing stress and injuries. One person can easily load the ladders without damaging the vehicle.

8 CHOOSE A RIVAL LED LIGHTING OPTION

A. Choose your preference of our interior lighting options.

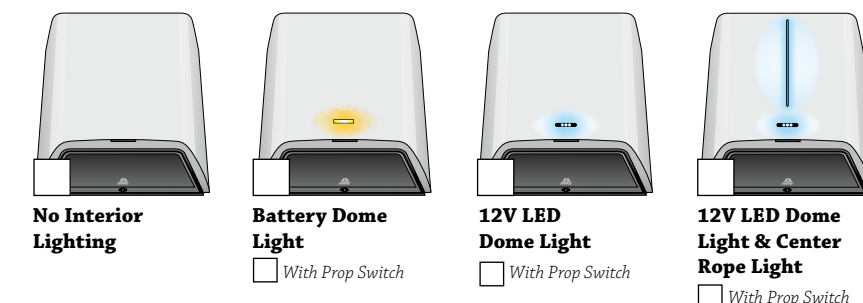

No Interior Lighting Battery Dome Light 12V LED Dome Light 12V LED Dome Light & Center Rope Light

With Prop Switch With Prop Switch With Prop Switch

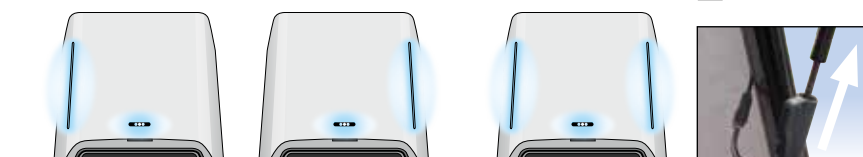

12V LED Dome Light, Driver Side Rope Light 12V LED Dome Light, Passenger Side Rope Light 12V LED Dome Light & Dual Rope Lights

With Prop Switch With Prop Switch With Prop Switch

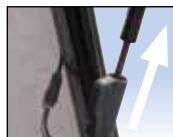

Optional Prop Switch turns your lights on/off, when you open/close your door.

HD SERIES WARRANTY

A.R.E. warrants to you, the original retail purchaser of an A.R.E. HD™, that the body will be structurally free from defects in material and workmanship for as long as you own your cap and the original vehicle. The body includes the fiberglass shell and mounting rails only. A.R.E. warrants to you, the original purchaser, for as long as you own your cap that the exterior paint will not abnormally fade or peel due to material or workmanship defect faster than the original pickup it was installed on by an authorized A.R.E. retail dealer.

The internal skeleton frame will be warranted for three (3) years from your retail date of purchase against failure due to defects in material and workmanship.

All other hardware will be covered under standard A.R.E. fiberglass truck cap warranties.

The A.R.E. HD™ has been designed to carry 550 lbs evenly distributed on the HD™ roof rack and 200 lbs evenly distributed in each toolbox.

CAUTION: The weight of this product and the weight of the cargo it was designed to carry may be more than your truck was designed to carry on the bed rails. Please consult your truck manufacturer.

WARNING: The use of this product may raise your vehicle's center of gravity, especially when loaded. Higher center of gravity is known to increase the chance of vehicle rollover.

TRUST THE LEADER

When you purchase our cap for your truck, you have 700 A.R.E. partners across North America ready to serve you. Major leasing companies rely on A.R.E. to provide caps and service to thousands of vehicles they own nationwide. You deserve the same peace of mind that they enjoy. See your local authorized A.R.E. dealer today to order the work cap that meets your needs.

ToolMaster™

ToolMaster™

FIBERGLASS CONTRACTOR PACKAGES

CONTRACTOR-GRADE DURABILITY. FIBERGLASS STYLING.

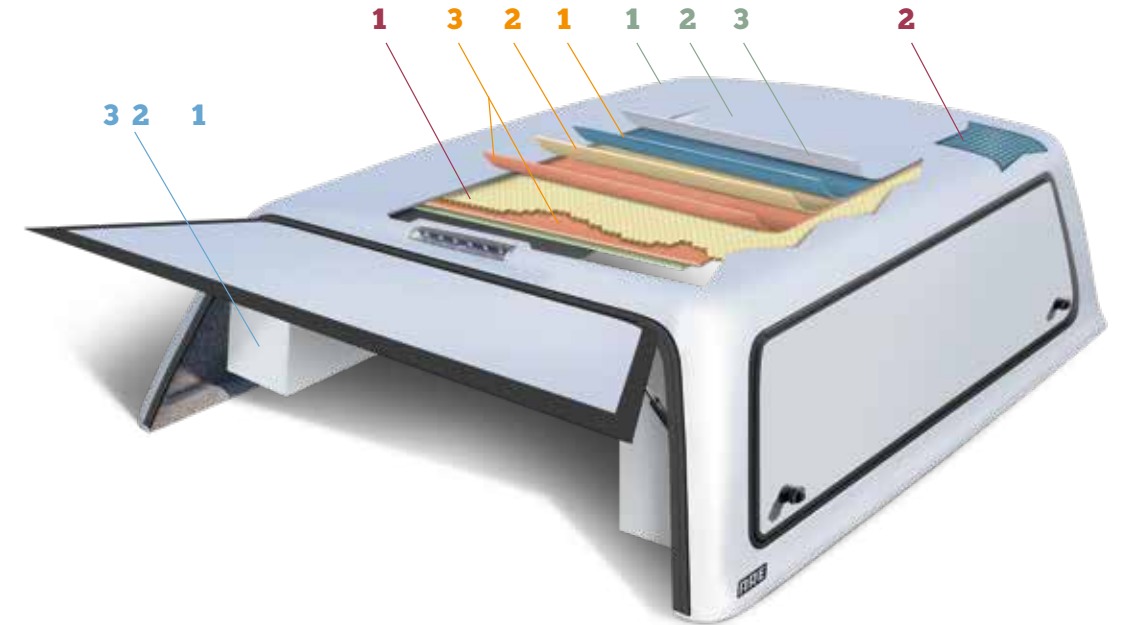

OPTIONS

- 1 3 Models V, CX or MX
- 2 Rear Doors – Aluminum security insert.
- 3 Side Toolboxes – 2 steel toolboxes (1 per side) and weight capacity of 120 lbs. per box.
- 4 Roof Racks – 3 different racks to meet your specific hauling needs.

STRUCTURE

- 1 Sandable Primer Gelcoat
- 2 Unique Polyester Resin Fiberglass Laminar
- 3 Low Filled Resin Fiberglass – Resin fiberglass provides a superior structure.

FINISH

- 1 Body Colors – A.R.E. offers our ToolMaster™ cap in any color to match your truck body.
- 2 Clear Coat Exterior – Lasting paint protection.
- 3 Automotive Grade Paint – Two-stage ChromaPremier® paint is offered in any OEM or fleet color code formula.

STRENGTH

- 1 Reinforced Roof
- 2 Extra Reinforcement



AluRack® commercial roof rack



Toolboxes are engineered for maximum space capacity



Toolboxes are securely fastened to roof framework

CONTRACTOR-GRADE DURABILITY

For years, A.R.E. has manufactured high-quality fiberglass caps and tonneau covers as well as rugged aluminum units for commercial use. With our Contractor packages, you can have the appearance and style benefits of our fiberglass caps and tonneau covers with the security and functionality of our commercial units.



ToolMaster™
MX



ToolMaster™
CX

Follow these 8 steps and check options clearly. **X**

Consult your local A.R.E. dealer for more details or with questions regarding any of the options shown here.

1 CHOOSE A CAP PROFILE

A. Choose the appropriate cap profile for your needs.

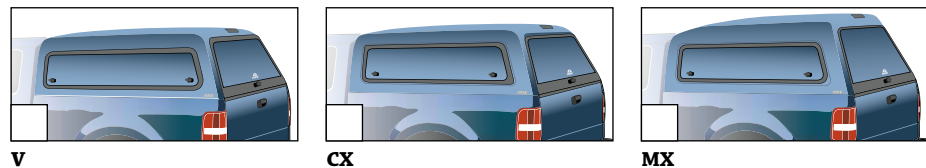

V

CX

MX

2 CHOOSE AN INTERIOR FINISH

A. Choose your preference of our two interior options.

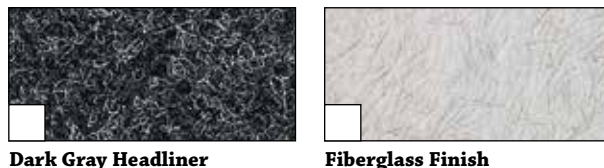

Dark Gray Headliner

Fiberglass Finish

3 CHOOSE A FRONT WINDOW OPTION

A. Choose the front window option based on your access and visibility needs.

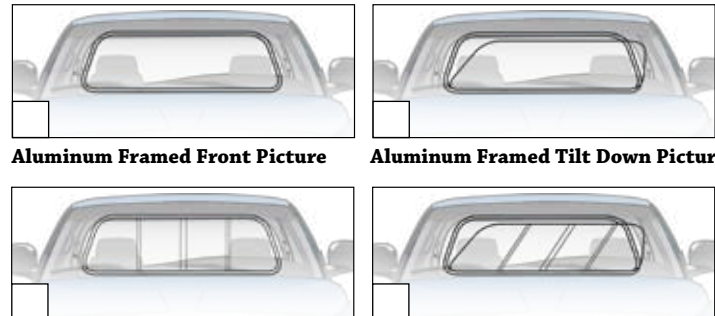

Aluminum Framed Front Picture

Aluminum Framed Tilt Down Picture

Aluminum Framed Sliding Window

Aluminum Framed Tilt-Down Sliding

4 CHOOSE A REAR DOOR

A. Choose the rear door and window option that provides the optimal accessibility on a daily basis.

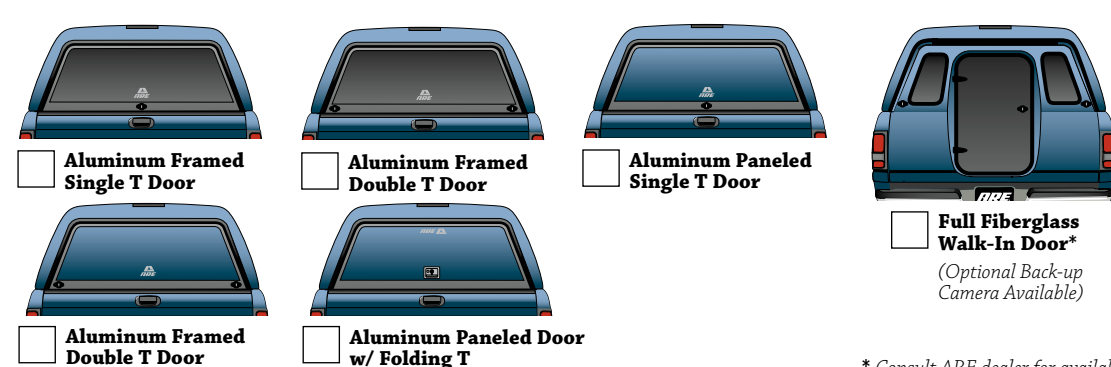

Aluminum Framed Single T Door

Aluminum Framed Double T Door

Aluminum Paneled Single T Door

Aluminum Framed Double T Door

Aluminum Paneled Door w/ Folding T

Full Fiberglass Walk-In Door*
(Optional Back-up Camera Available)

* Consult ARE dealer for availability

5 CHOOSE A SIDE WINDOW OPTION

A. Choose the side option that fits your needs for access and visibility.

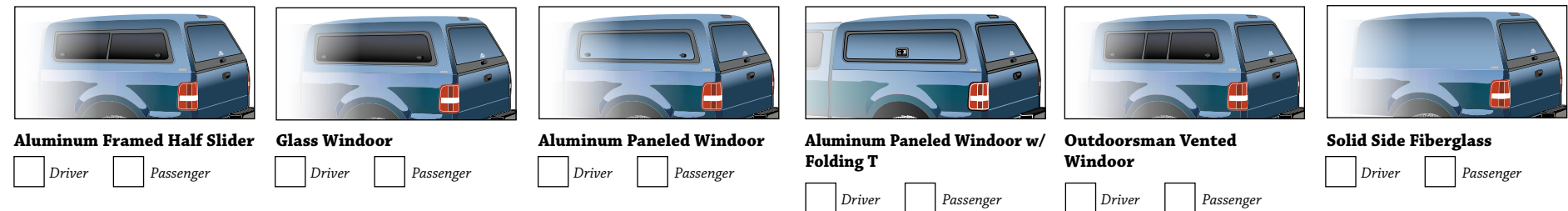

Aluminum Framed Half Slider

Glass Window

Aluminum Paneled Window

Aluminum Paneled Window w/ Folding T

Outdoorsman Vented Window

Solid Side Fiberglass

Driver Passenger

Driver Passenger

Driver Passenger

Driver Passenger

Driver Passenger

Driver Passenger

6 CHOOSE A TOOLBOX AND SHELVING OPTIONS

A. Choose to have either toolbox storage or an easy access opening on either side.

No Toolbox
 Driver Passenger

Standard Toolbox
 Driver Passenger

B. Choose the insert option shown below or choose to have no shelves at all.

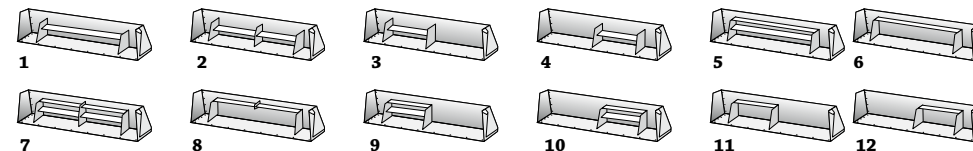

Toolbox Shelving Options Driver Side _____ Passenger Side _____

Akro Bins

7 CHOOSE A LADDER RACK OPTION

A. Choose a ladder rack that is perfect for your storage needs.

No Ladder Rack



Universal Mounting Tracks



Yakima® CoreBar Roof Rack (Steel)



Yakima® JetStream Roof Rack (Aluminum)



KargoMaster Ladder Rack

PRIME DESIGN

ErgoRack®



YAKIMA

AluRack®

Double Clamping Double Rotational Driver Side Clamp and Passenger Side Rotational

Optional Step Ladder Adaptor
Only available for Prime Design models on 8 foot beds.

80" AluRack®
Aluminum Rack System

98" AluRack®
Aluminum Rack System

120" AluRack®
Aluminum Rack System

KARGO MASTER

AluRack® Optional Add-On:
Quick Clamp Ladder Lock Attachment

Driver Passenger

EASY-LOADING ROLLER SYSTEM
Allows ergonomic loading and unloading of ladders, reducing stress and injuries. One person can easily load the ladders without damaging the vehicle.

8 CHOOSE A RIVAL LED LIGHTING OPTION

A. Choose your preference of our interior lighting options.

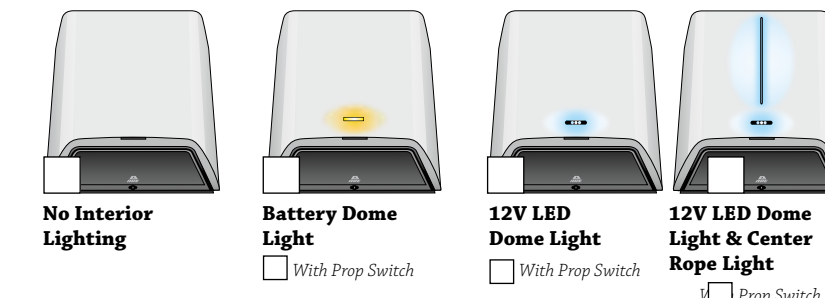

No Interior Lighting

Battery Dome Light
 With Prop Switch

12V LED Dome Light
 With Prop Switch

12V LED Dome Light & Center Rope Light
 Prop Switch

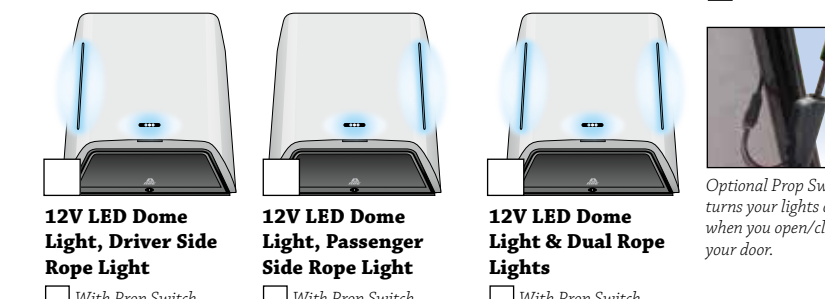

12V LED Dome Light, Driver Side Rope Light
 With Prop Switch

12V LED Dome Light, Passenger Side Rope Light
 With Prop Switch

12V LED Dome Light & Dual Rope Lights
 With Prop Switch

Optional Prop Switch turns your lights on/off, when you open/close your door.

TOOLMASTER WARRANTY

A.R.E. warrants to the original purchaser of ToolMaster™ truck caps that they are free from defects in structure, materials and workmanship for lifetime from the date of purchase from an authorized A.R.E. dealership. See the dealership for a copy of the full warranty statement.

TRUST THE LEADER

When you purchase our cap for your truck, you have 700 A.R.E. partners across North America ready to serve you. Major leasing companies rely on A.R.E. to provide caps and service to thousands of vehicles they own nationwide. You deserve the same peace of mind that they enjoy. See your local authorized A.R.E. dealer today to order the work cap that meets your needs.





DOUBLE COVER™

FUNCTIONALITY MULTIPLIED

Reimagine what you thought about bed covers. Trying to decide between a retracting cover or a hinged cover? Don't. The DoubleCover allows you to have quick bed access with its heavy-duty front hinge, but also achieve full bed access with its retracting feature. Designed to take your truck to the next level in functionality and looks, the DoubleCover is a great solution for today's trucks.

STANDARD FEATURES

- Lifts up and retracts
- Open canister for easy clean out
- Center lock
- Recessed side handles for retracting
- Aluminum construction with powder coat finish



LIFTS UP & RETRACT

FUSION

PURPOSE FOCUSED, STYLE DRIVEN

Our belief has always been that you shouldn't have to sacrifice style for function. The Fusion combines tri-fold accessibility with paint-to-match finishing. Whether you need your truck to be your work companion all day or want a more stylish look when you are off the jobsite, the Fusion is your trucks perfect complement.

STANDARD FEATURES

- Tri-fold cover
- Paint-to-match panels
- Carpeted under panels
- Low-profile design
- Universal tailgate operation
- L-rail for quick and easy install
- Battery operated L.E.D. light





3DL™

UNPARALLELED ACCESS

A.R.E.'s Commercial Division is expanding its product line with the 3DL™. Available for many of today's trucks. This tonneau cover exemplifies another innovative design from A.R.E. that makes loading and unloading easier for service workers. The 3DL™ turns the bed of the truck into an organized and readily accessible tool container that keeps dust and other elements out.

STANDARD FEATURES

- Two doors on each side
- The entire cover opens effortlessly from the rear of the truck using a hinge system at the front of the cover
- Roller rods for side doors allow for one-hand operation to provide easy access and improved seal
- Painted-to-match
- Design offers the driver excellent rear visibility from the cab of the truck
- Designed to keep products secure and out of sight
- Patented Palm Handle (black)

OPTIONAL FEATURES

- Remote keyless entry
- Rival LED strip lighting technology to illuminate the bed
- Diamond plate toolboxes

SPECIFICATIONS

- Adds over 4" above the truck bed rail of additional storage space



OPTIONAL DIAMOND PLATE TOOLBOX



RIVAL LED ROPE LIGHT OPTION ACTIVATED WHEN ANY DOOR OPENS



REMOTE KEYLESS ENTRY OPTION



LSII™

#1 FIBERGLASS TONNEAU COVER

The LSII™ offers truck specific styling, premium components and a unique lift assist system for user friendly opening and closing. With a sleek, clean appearance, a proven lock/latch system, a dry and out-of-sight storage area for tools and equipment and better rear visibility when backing up, this industry-leading tonneau cover is a best seller, and for good reason.

The LSII™ gives technicians and supervisors who live in gated communities with vehicle restrictions the ability to take their work trucks home.

STANDARD FEATURES

- Paint-to-match
- Slam latch system
- Lift assist arms
- Dark gray headliner
- Automotive grade lock system
- Continuous front hinge

POPULAR OPTIONS

- Rival by A.R.E. LED lighting
- Keyless entry



The LSII™ allows a pickup to get better gas mileage than it would with an open bed.



LOW PROFILE COMPOSITE CLAMP



HEIGHT ADJUSTERS PREVENT UNNECESSARY



MODULAR BASERAIL WITH WEATHER-RESISTANT SEAL



PULL STRAP



PALM HANDLE WITH SLAM LATCH SYSTEM



CHOOSE YOUR CARGOGLIDE®



CG1000
1000 lbs. capacity

75% of the cargo tray length slides out on short bed trucks and 70% on long beds. Sturdy steel frame construction. Real plywood deck with a laminated surface for strength and durability. 6 bearings total, 2 full complement permanently sealed ball bearings, 2 side thrust and 2 powerful needle bearings provide dependable lasting support for the cargo you haul in your CargoGlide.

Industrial 4" high extruded 6061-T6 thick anodized aluminum side rails with a slot style infinitely adjustable tie down track around all 3 sides, and includes 4 adjustable marine-grade tie down eyebolts to make securing cargo easy and versatile.



CG1500XL
1500 lbs. capacity

100% of the cargo tray length slides out for total access to your cargo. Real plywood deck with a laminated surface for strength and durability. 36 bearings total, 4 full complement double row, 16 single row permanently full complement sealed ball bearings and 2 cam follower sealed needle bearings provide dependable lasting support for the cargo you haul in your CargoGlide. This slide also has 14 more sealed side thrust bearings that make it slide easier when used on uneven ground.

Powder coated industrial 4" high extruded 6061-T6 aluminum side rails with a slot style infinitely adjustable tie down track around all 3 sides, and includes 4 adjustable marine-grade tie down eyebolts to make securing cargo easy and versatile. 8" high side extensions on the first 4' of the slide at the cab end helps contain more cargo.



CG1500
1500 lbs. capacity

75% of the cargo tray length slides out on short bed trucks and 70% on long beds. Sturdy steel frame construction. Real plywood deck with a laminated surface for strength and durability. 8 bearings total, 6 full complement permanently sealed ball bearings and 2 side thrust bearings provide dependable lasting support for the cargo you haul in your CargoGlide.

Industrial 4" high extruded 6061-T6 thick anodized aluminum side rails with a slot style infinitely adjustable tie down track around all 3 sides, and includes 4 adjustable marine-grade tie down eyebolts to make securing cargo easy and versatile.



CG2200HD
2200 lbs. capacity

75% of the cargo tray length slides out on short bed trucks and 70% on long beds. Real plywood deck with a laminated surface for strength and durability. 10 bearings total, 4 full complement double row, 6 single row permanently sealed ball bearings provide dependable lasting support for the cargo you haul in your CargoGlide.

Industrial 4" high extruded 6061-T6 thick anodized aluminum side rails with a slot style infinitely adjustable tie down track around all 3 sides, and includes 4 adjustable marine-grade tie down eyebolts to make securing cargo easy and versatile. 8" high side extensions on the first 4' of the slide at the cab end, helps contain more cargo.



CG2200XL
2200 lbs. capacity

100% of the cargo tray length slides out for total access to your cargo. Real plywood deck with a laminated surface for strength and durability. 22 bearings total, 4 full complement double row, 16 single row permanently sealed ball bearings and 2 cam follower sealed needle bearings provide dependable lasting support for the cargo you haul in your CargoGlide.

Powder coated industrial 4" high extruded 6061-T6 aluminum side rails with a slot style infinitely adjustable tie down track around all 3 sides, and includes 4 adjustable marine-grade tie down eyebolts to make securing cargo easy and versatile. 8" high side extensions on the first 4' of the slide at the cab end, helps contain more cargo.

CARGOGLIDE® CARGO MANAGEMENT SOLUTIONS

The Easiest Way to Load and Unload

Say goodbye to the aggravation of a normal truck bed. With a CargoGlide® bed slide, you can stop crawling in the back of your truck or van every time you need to reach your gear. So stop scuffing your knees and breaking your back! Install a CargoGlide® in your truck and get your gear and materials out where you need them!

CargoGlide offers models that hold 1,000 lbs., 1,500 lbs. or even 2,200 lbs. Their full extension models slide out of the bed 100%, so you can eliminate the risk of injury for you or your employees.

Combined with an A.R.E. Truck Cap or Cover, the CargoGlide allows you to get maximum use out of your truck bed!



TRUCKVAULT® 2-DRAWER BED STORAGE SYSTEM



- Comes standard with two drawers, and folding t-handle lock
- No-drill turn buckle installation
- 5/8" medium density overlay (MDO) top surface will support up to 2,000 lbs. on top of TruckVault®
- Exterior finish: dark gray polypropylene, matches A.R.E. cap or cover carpeted interior option
- Interior finish: drop-in ¼" rubber mat
- Limited lifetime warranty – see your local retailer or www.truckvault.com for complete warranty information
- Approximate width: 39–48" based on bed width
- Approximate length: 46–94"+ based on bed length
- Approximate height: 10.5–12.5" based on truck model
- Standard drawer depth: 8"
- Each drawer holds up to 250 lbs.

STANDARD ACCESSORIES



Folding T-handle lock



No-drill turn buckle installation



Drop-in rubber mat drawer interior

ADDITIONAL ACCESSORIES



Drawer dividers (front to back and side to side)



Top rubber mat



LED light (battery)



Tie down rails with cargo rings

SAFETY LIGHTING



STROBE
LUMENS: 300 AMBER
LUMENS: 700 WHITE
Remote or switch controlled



LUMALARM
DECIBELS: 97
LUMENS: 200 AMBER

BEACON
LUMENS: 1700
Permanent or Magnetic Mount



WORK LIGHTS



ROUND
LUMENS: 1800



ROUND
LUMENS: 1400



LED HYBRID
LUMENS: 2500



SQUARE
LUMENS: 3000



Rival Lighting by A.R.E.

Rival by A.R.E. is a full LED lighting product line featuring factory-installed options on an A.R.E. product, as well as individually offered lighting to allow you to customize your fleet vehicles. To learn more about Rival visit www.4are.com/product/rival.



Outfit for Work®

WWW.4ARE.COM / 1.800.649.4ARE



A.R.E. AUTHORIZED DEALER



P.O. Box 1100, Massillon, Ohio 44648
www.4are.com / 1.800.649.4ARE
contact@4are.com
www.facebook.com/aretruckcaps
@areaccessories
© A.R.E. Accessories, LLC., 2019



ATTN: STATE OF CALIFORNIA CONSUMERS
WARNING: Cancer and Reproductive Harm - www.P65Warnings.ca.gov.

Products in this brochure are subject to California Prop 65.

20354M/588 04/2019

COMMERCIAL PRODUCTS

