

2005

ENDURA

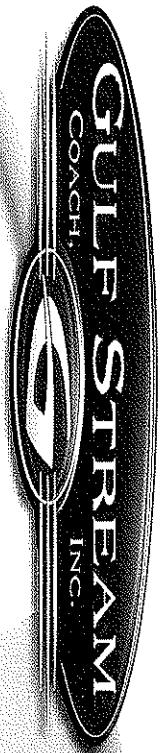

Class C Style. Class A Features



ENDURA

2005-2006

ENDURA

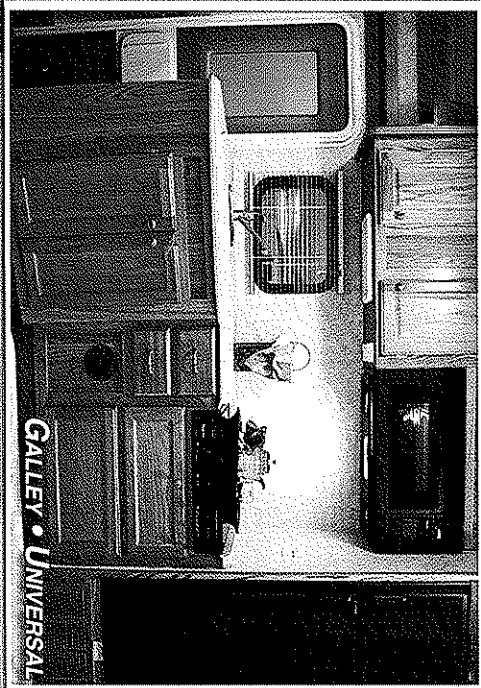

GALLEY • UNIVERSAL

GALLEY CONVENIENCE...

Our wide-open galley offers all the comforts of your kitchen at home. With the 3-burner high performance range; 2-door, 2-way refrigerator and large convection microwave oven, you will be able to prepare any of your family's favorite meals.

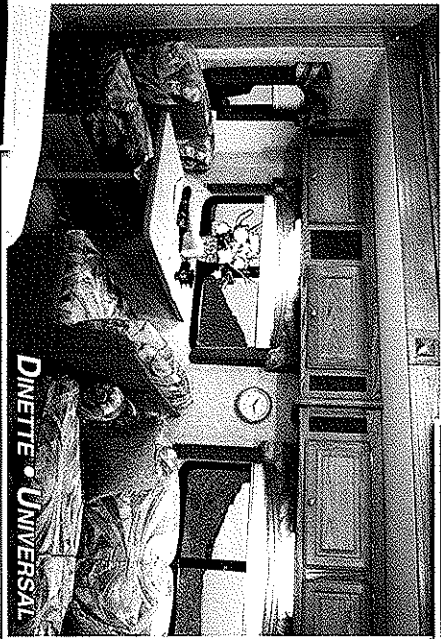

DINETTE • UNIVERSAL

FINE DINING...

Set in the deep comfort of the Endura's slideout surrounded by windows, this dinette features Comfort Plus seating and large surface area table. Our dinettes give you plenty of area to enjoy all the activities of the RV lifestyle and room to dine.

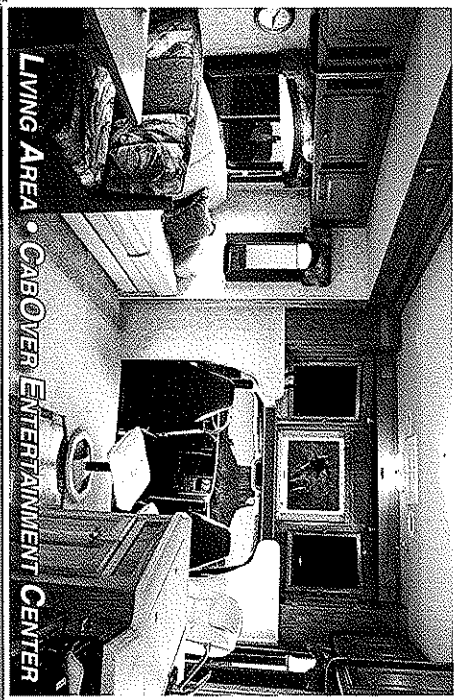

LIVING AREA • CABOVER ENTERTAINMENT CENTER

SPACIOUS LIVING...

With the largest slideout in the class C industry, the Endura gives you spacious living and plentiful storage. The main living space features hardwood cabinetry, full kitchen, deluxe carpet, Comfort Plus sofa, dinette seats, and stand alone chair, residential hardware and fixtures, and your choice of either a cabover sleeping area or cabover entertainment cabinet featuring a 27" Flat screen Television and 5.1 surround sound system to entertain you and your family during your travels.

ERGONOMIC COCKPIT...

The Cockpit of the Chevrolet Kodiak Chassis puts the controls of your rig and driving entertainment at the tips of your fingertips. Ergonomic features include, 16" steering wheel, visor mounted backup monitor, fully adjustable seats and High visibility rearview mirrors and windshield. The safety of Dual airbags will also add to your peace of mind and comfort.

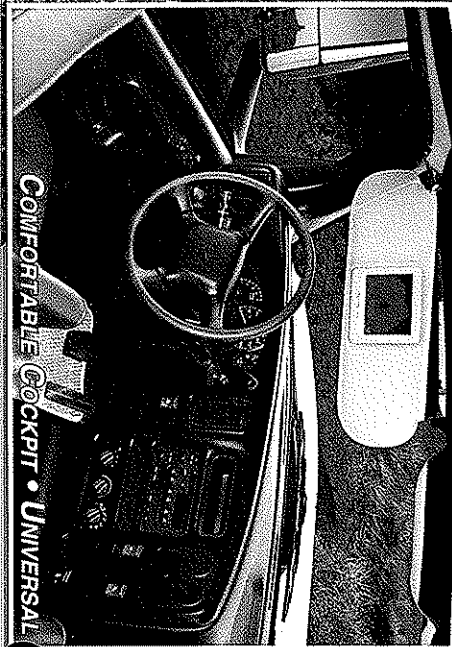

COMFORTABLE COCKPIT • UNIVERSAL

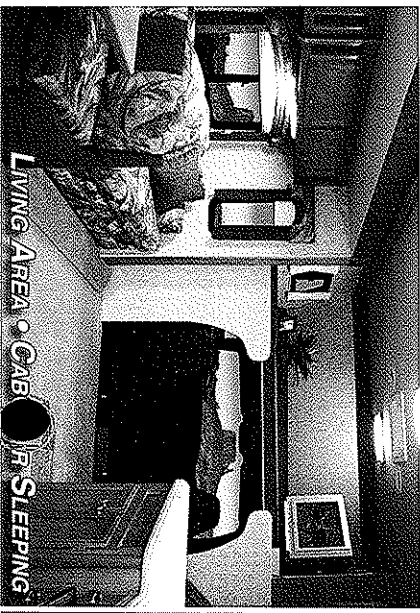

LIVING AREA • CABOVER SLEEPING



LIVING AREA • MODEL 6340

GULF STREAM
COACHES
INC.

ENDURA

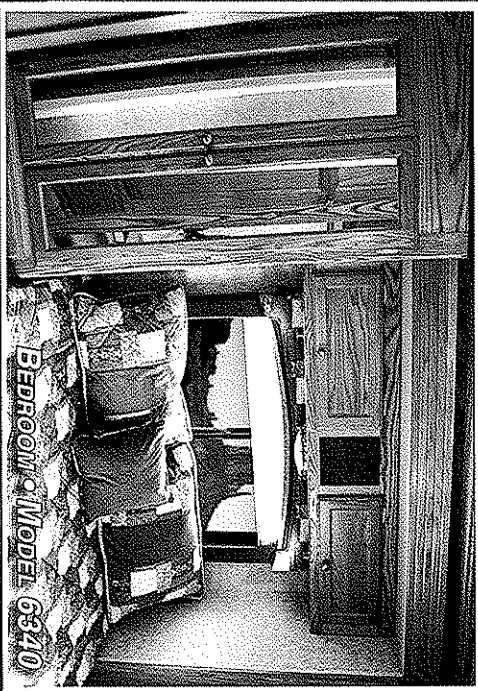

BEDROOM • MODEL 6340

COMFORTABLE SLEEP...

Gulf Stream knows that a good night's rest is important for you to enjoy your time in your new home on wheels. With a queen bed in the rear of the coach, a convertible dinette and incredibly spacious cabover sleep area you have the ability to comfortably sleep six people.



CABOVER SLEEPING • UNIVERSAL

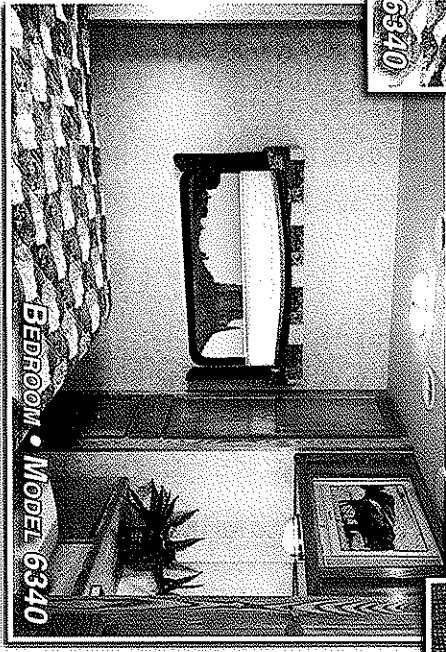

BEDROOM • MODEL 6340

BEDROOM...

The Endura gives you three floorplan options when it comes to the rear bedroom area. The 32' 6316 single slide features a bedroom/bathroom combination. The 35' 6340 doubleslide features enormous wardrobe storage, vanity and 20" flatscreen TV. The 37' 6378 tripleslide featuring two-zone living also includes large wardrobe storage, 19" TV, a large rear bay window and two free-standing chairs giving you the ability to utilize the bedroom as a private area during the day as well.

SPACIOUS BATHROOM...

The bathroom in the Endura 6378 gives you the same bathroom setup as our high end diesel class A models. With french doors, hardwood and residential shower you will feel at home with residential style amenities. The shower features a skylight and hand held shower head for your convenience. Undersink storage and medicine cabinet are also added to help you store all your personal products out of the way.



BATHROOM • MODEL 6378



BEDROOM • MODEL 6378



GULF STREAM
COACH, INC.

TWO ZONE LIVING ROOM
COPR. 6378

ENDURA

Chevy Hodiak's Chassis

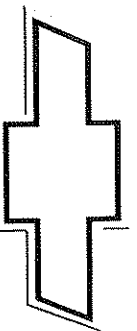

Exclusively brought to you by Gulf Stream Coach

MULTI-LEAF
SUSPENSION

RUST-PROHIBITIVE
COATING ON FRAME

ERGONOMICALLY
SPACED STEPS

OPTIONAL ON ALL MODELS

STABIL-RIDE™

Suspension System

The best just got better. The optional Stabil-Ride™ suspension system integrates parabolic leaf springs, auxiliary springs, a stabilizer bar and tuned shocks, designed to provide a low maintenance, stable ride comparable to the ride of a diesel pusher. Enjoy unsurpassed handling with reduced body sway particularly while cornering and superior straight-line stability.

- INTENSE 19,500 LB. GVWR
- UP TO 2,700 LBS. CARGO CARRYING CAPACITY*
- SUPERIOR TOWING CAPACITY 26,000 GCWR

* CCC (Cargo Carrying Capacity) is equal to the GVWR minus each of the following: UVW, full fresh (potable) water weight (including water heater), full LP Gas weight, and SCWR



Optional built in backup monitor in the driver's footwell area. The monitor provides a clear view of the rear of the vehicle. The monitor is mounted on a swivel base and can be adjusted to the driver's preference. The monitor is powered by the vehicle's electrical system and is protected by a clear plastic cover.

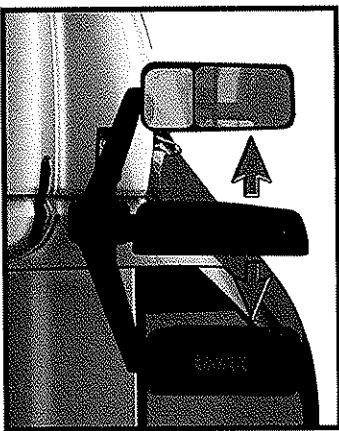

Breakaway mirrors fold 90 degrees inward or outward to maintain a clear view of the road. The mirrors are designed to be easily accessible and are mounted on a swivel base. The mirrors are powered by the vehicle's electrical system and are protected by a clear plastic cover.

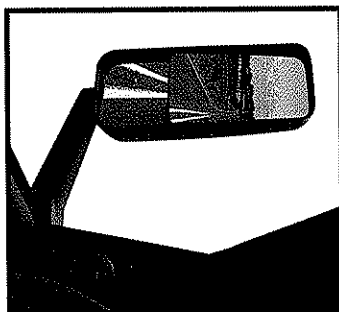

126-square inch-surface mirror including a 6x7 inch convex section on both mirrors. The mirror is designed to provide a wide field of view and is mounted on a swivel base. The mirror is powered by the vehicle's electrical system and is protected by a clear plastic cover.

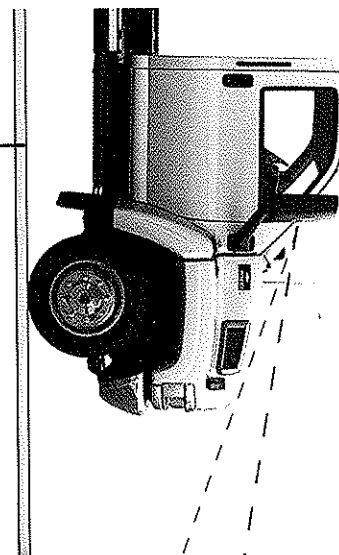

OPTIONAL

**BREAKAWAY
MIRRORS**

**EASY ACCESS
PULL FORWARD HOOD**

**POWERFUL CHEVROLET
VORTEC GAS OR
DURAMAX DIESEL**

**UP-LEVEL HEADLIGHTS
WITH CHROME TREATED
FRONT BUMPER AND GRILL**

**FOUR WHEEL
DISC BRAKING**

- 10,000 LB. HITCH RATING
- 19.5" TIRES
- DRIVER AND PASSENGER AIRBAGS
- DAYTIME RUNNING LIGHTS
- AM/FM CD PLAYER

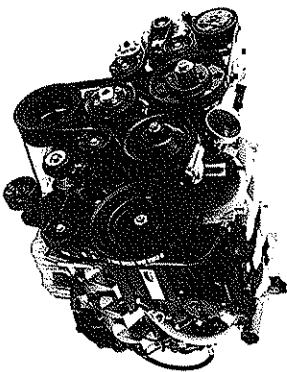
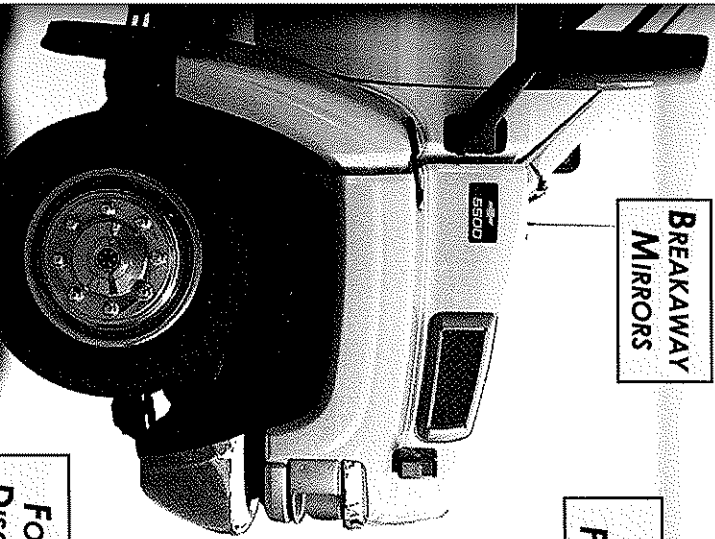

**VORTEC™ 8.1 LITRE V8
GASOLINE ENGINE (standard)**

HP	450
Torque LB-FT	545
325hp	

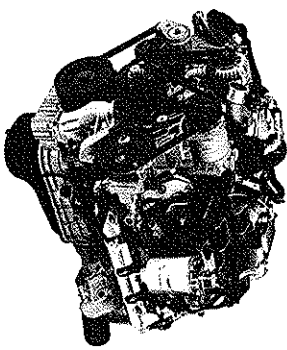

**DURAMAX™ 6600 V8
TURBO DIESEL ENGINE (optional)**

HP	520
Torque LB-FT	520
300hp	

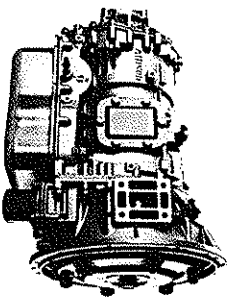

**ALLISON™ 1000 SERIES
AUTOMATIC TRANSMISSION (standard)**

5 speed	Gross Torque (lb-ft)
1000	545

VISIBILITY AND MANEUVERABILITY

Negotiating a ticky curve in the campground or on a major city street there will be no reason to worry while you're in the Chevrolet Kodiak. With a 54 degree turning radius, giant mirrors, large windshield and sloped hood this vehicle drives more like a light duty truck. Sloped hood allows the driver to see just a mere 13 feet in front of them, doubling their field of vision versus the competition's 26 feet.



BEST-IN-CLASS TURNING RADIUS

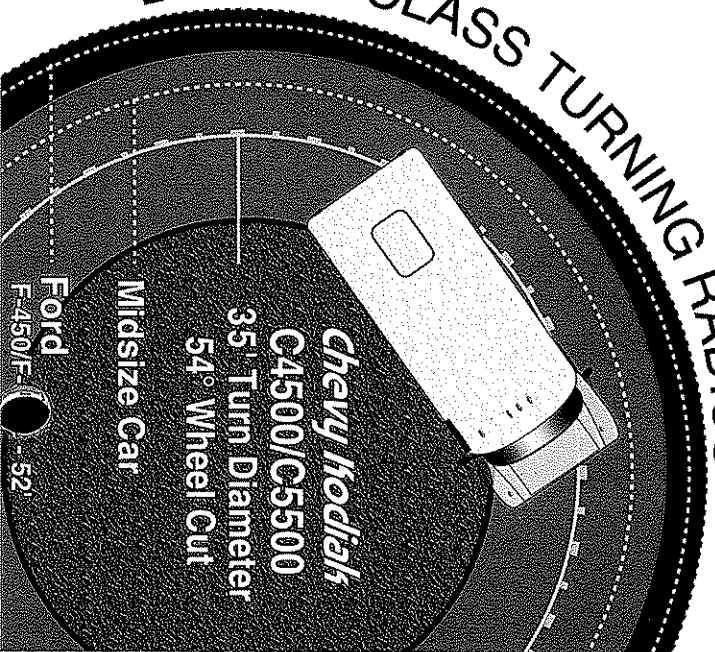

**Chevy Kodiak
C4500/C5500
35" Turn Diameter
54° Wheel Cut**

Midsize Car

**Ford
F-450/F-550**

CHEVROLET **KODIAK C5500** - VISIBILITY AT 13 FEET FORD **F450/F550** - VISIBILITY AT 26 FEET

Endura Enclosure Features & Benefits

SOLID HARDWOOD CABINETRY

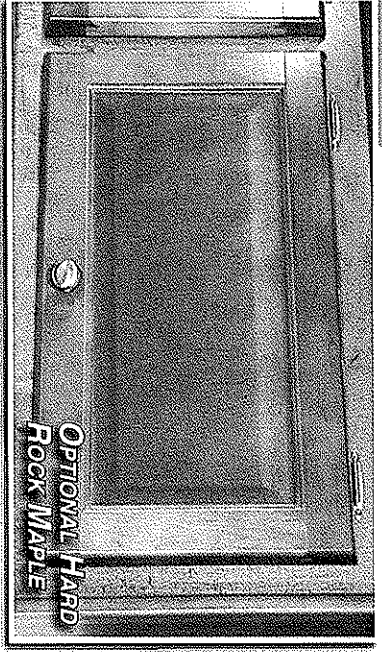

OPTIONAL HARD ROCK MAPLE

PREDRIILLED HARDWOOD CONSTRUCTION

Our residential style cabinets are constructed of solid hardwood doors and fronts that are predriilled and screwed then they are stained and top coated with a furniture grade finish that provides long lasting beauty and durability as well as adding strength and quietness to your motorhome.

COMPETITOR'S CABINETRY

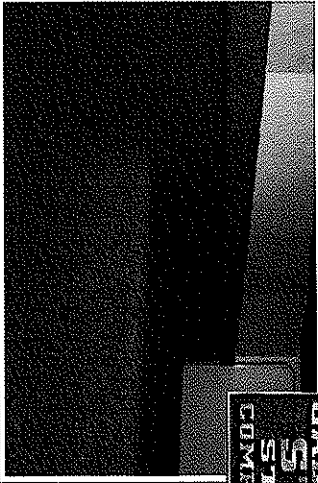

GALVANIZED STEEL STORAGE COMPARTMENTS

Seamless carpeted side walls - steel storage compartments safely cradle your valuable possessions and your family's most protective and loved possessions.

Other companies use wrapped cabinet fronts prone to peeling, fading and tearing. The softer composite wood used does not hold screws as well as hardwood resulting in loss of strength and squeaking. Discoloration will degrade the beauty and lower the value of the motorhome.

Excellent Weathering -

Maintaining the vehicle's quality appearance enhances its resale value.

Tear Resistance - Flexroof's hard abuse resistant finish resists tearing, a condition that can cause leaks and lead to expensive repair.

Low Maintenance - Road grime can easily be removed with normal cleaning maintenance. Rubber chalking due to solar breakdown of the roof surface is eliminated, preserving the original appearance and resale value of the vehicle.

Stain Resistance - Fiberglass Flexroof is designed to resist staining and maintain its quality appearance.

Structural Integrity - Unlike conventional EPDM rubber roof membranes, Flexroof is a structural component of the roof system.

Textured Fiberglass - Helps dissipate heat and prevents free limbs from tearing or scratching your roof.

Seamless FIBERGLASS ROOF

FLUSH FLOOR Side out rooms

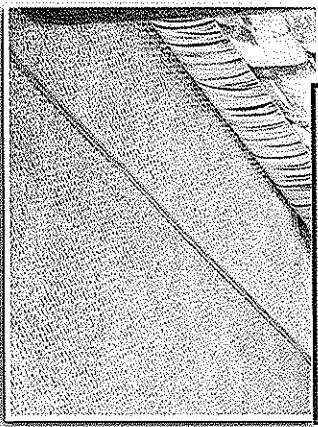

Gulf Stream offers true flush floor slide out rooms to give you more headroom in the slide and eliminates the step up into the slide room that you will experience in many of our competitors' motorhomes.

Comfort Plus+ Seating

Comfort Plus furniture by Gulf Stream Coach features residential styling, solid construction, total comfort and a comprehensive warranty.

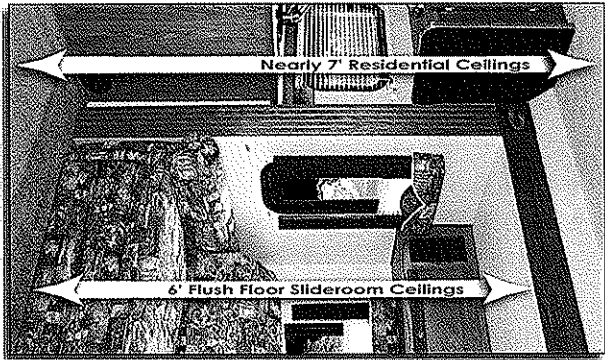

Nearly 7' Residential Ceilings

6' Flush Floor Slideroom Ceilings

The Endura has nearly 7' interior ceilings for a residential look and feel with 6' foot ceilings in the slideroom.

Cradle of Strength

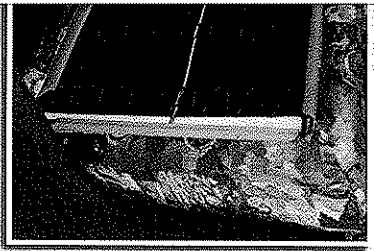

1. Seamless Fiberglass Roof For Greater Energy Efficiency and Dependability.
2. Luan Decking for Additional Strength.
3. Molded, High Density EPS (Expanded Polystyrene) Foot Brick Insulation - Provided Consistent Insulation Value as well as Superior Dimensional Rigidity.
4. One-Piece Formed Aluminum Air Conditioning Duct Completely Surrounded By EPS Insulation.
5. Bubble-Wrapped Foil Insulation Provides Superior Insulation and Helps Prevent Condensation.
6. Rugged Welded Tubular Aluminum Roof Framing. Welded to Form the Sidewall Framing.
7. Rugged Heavy-Gauge Tubular Aluminum, Fixture Welded to Form the Sidewall Framing.
8. High-Density EPS Insulation Provides Superior Lamination and Bonding Characteristics and Insures Greater Energy Efficiency.
9. Interior Wall Panels Securely Laminated to Sidewall Framing.
10. "Super Stick" Fiberglass Exterior Vacuum-bond Laminated to Sidewall Framing for Lasting Beauty and Durability.
11. High-Quality Stain-Resistant Carpeting Available in Designer Coordinated Colors.
12. Extra-Thick Padding Under Carpet Provides Extra Comfort and Increases Carpet Durability.
13. Seamless Structurwood Floor Decking Laminated to Steel Floor Structure Assures a Quiet, Long-Lasting Rigid Floor.
14. Heavy-Gauge Tubular Steel Framing, Fixture Welded for Extra Strength and Stability.
15. Heavy-gauge Tubular Steel Framed, Fixture Welded Floor Truss System Provides the Strongest Foundation in the Industry.
16. Seamless Layer of Galvanized Steel Securely Laminated to the Steel Floor Framing.
17. Galvanized Steel Used to Form Each Storage & Holding Compartment.
18. Durable All-Weather Carpeting Completes Each Accessible Storage Compartment, Providing Extra Protection for Luggage and Valuables.
19. Rust-Prohibitive Paint Coating Applied to All Steel Framing Assures Corrosion and Rust Protection.
20. The Industry's Strongest, Most Spacious Exterior Storage Compartments.
21. Reinforced Heavy-Gauge Steel "W" Transition.

TAKE THE TIME TO COMPARE...
and you will see the exceptional value of a Gulf Stream Coach

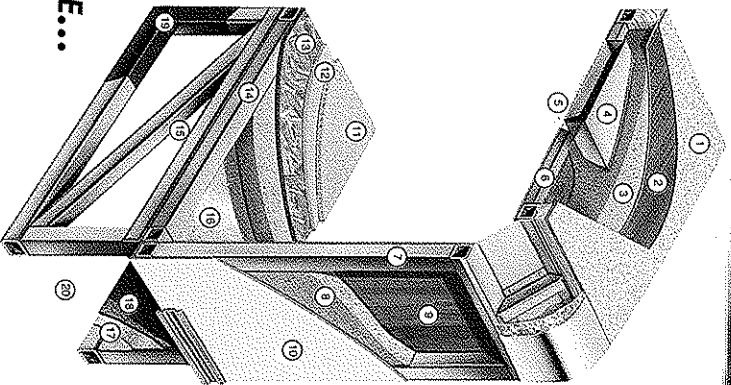

SUPER STRENGTH TRUSS SYSTEM

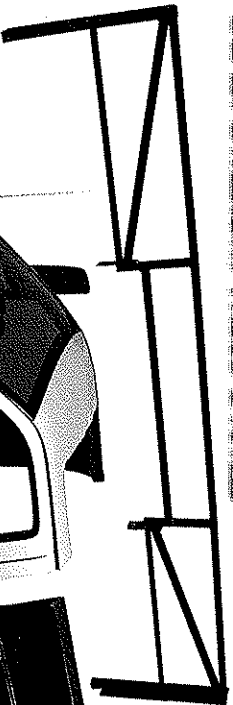

8" C CHANNEL EXTENSION

TUFF TRUSS!
6000 lbs!

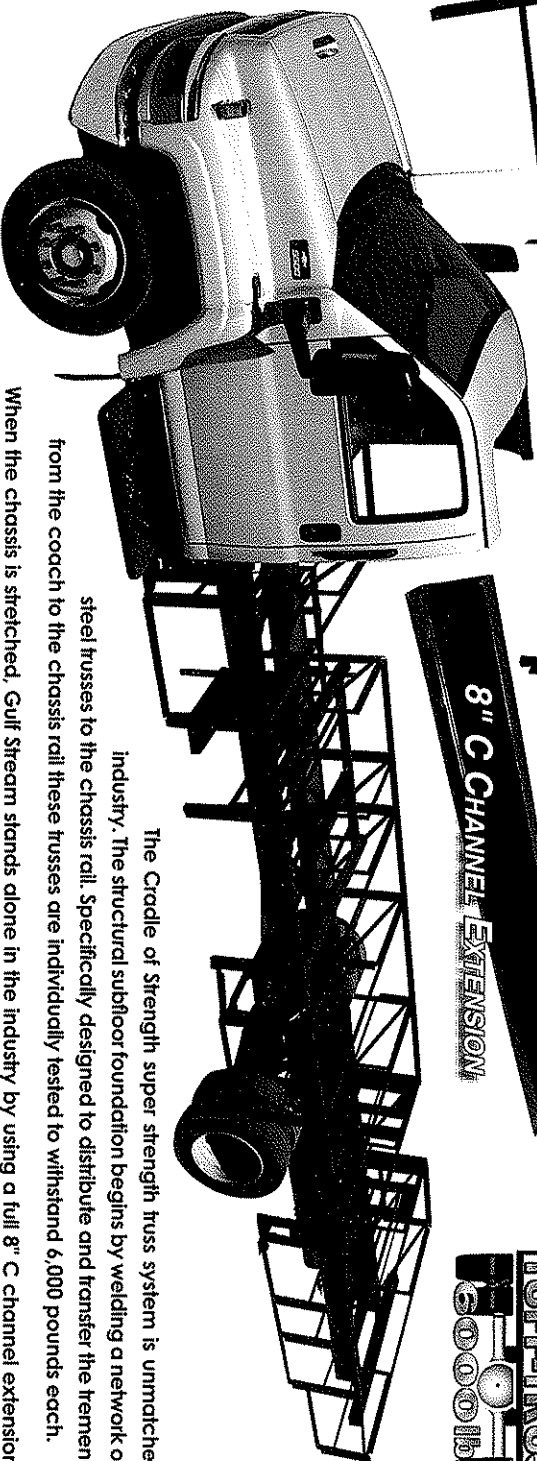

The Cradle of Strength super strength truss system is unmatched in the RV industry. The structural subfloor foundation begins by welding a network of integrated steel trusses to the chassis rail. Specifically designed to distribute and transfer the tremendous forces from the coach to the chassis rail these trusses are individually tested to withstand 6,000 pounds each.

When the chassis is stretched, Gulf Stream stands alone in the industry by using a full 8" C channel extension versus the traditional 4" or less. This practice adds to the strength of foundation and offers peace of mind that towing is safe on an extension that is true to the chassis.

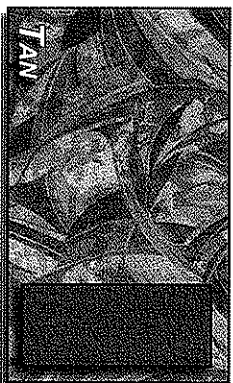

TAN

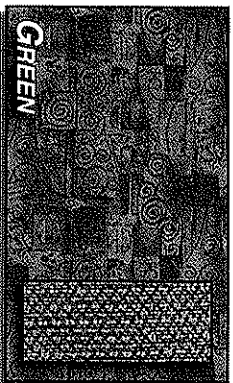

GREEN

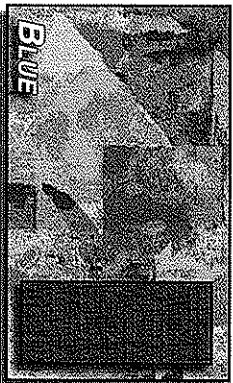

BLUE



PLATINUM

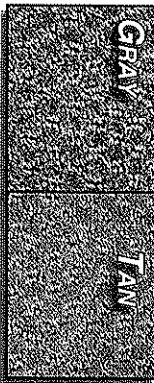

GRAY

TAN

Gray Carpet Available with Blue or Platinum. Tan Carpet Available with Tan or Green.

NICKEL PLATE HARDWARE

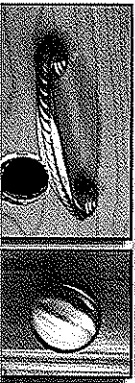

ENDURA

MODEL 6316

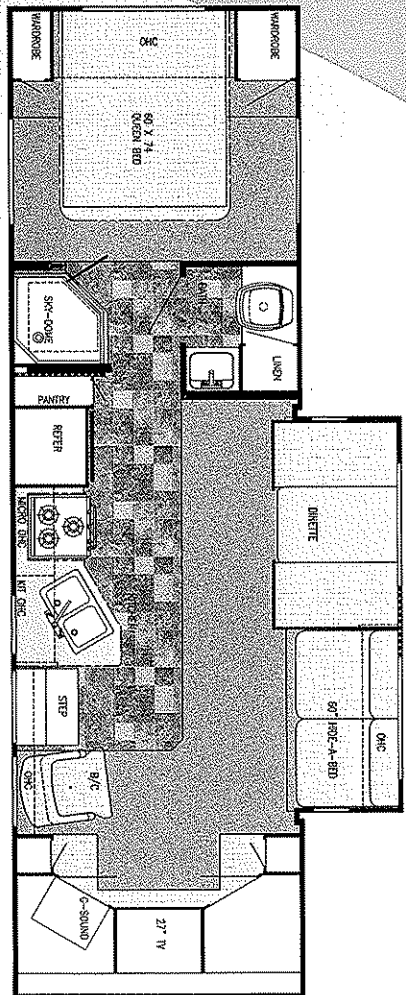

Chassis	Chevy Kodiak
Engine	V 8
Fuel	80
GVWR	19,500
Length	32'-11"
Width	101"
Height w/AC	11'-10.5"
Interior Height	83"
Wheelbase	213.5"
Fresh	54 gal.
Grey	52 gal.
Black	52 gal.
LP Gas Tank	64 lbs.
Furnace (BTU's)	30,000
Water Heater w/DSI	6 gal.

MODEL 6340

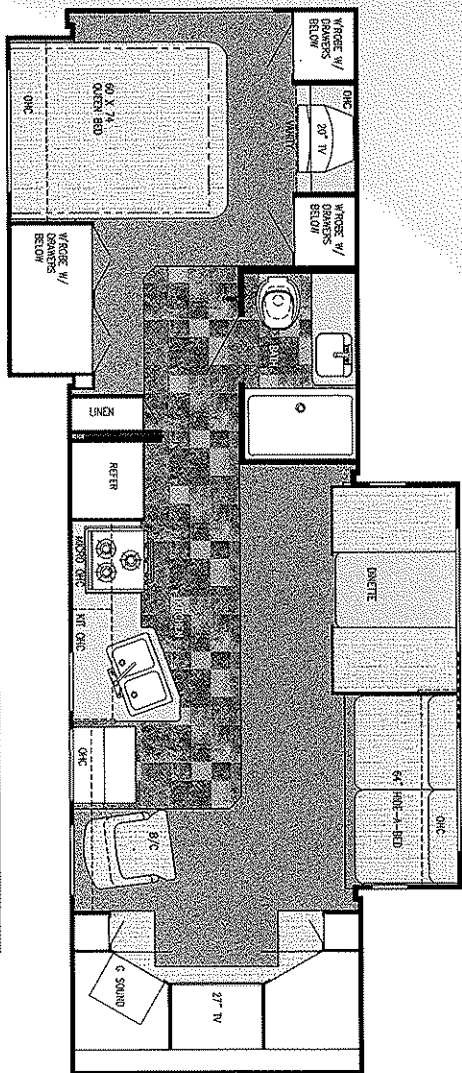

Chassis	Chevy Kodiak
Engine	V 8
Fuel	80
GVWR	19,500
Length	35'-1"
Width	101"
Height w/AC	11'-10.5"
Interior Height	83"
Wheelbase	239.5"
Fresh	94 gal.
Grey	52 gal.
Black	52 gal.
LP Gas Tank	64 lbs.
Furnace (BTU's)	35,000
Water Heater w/DSI	6 gal.

MODEL 6378

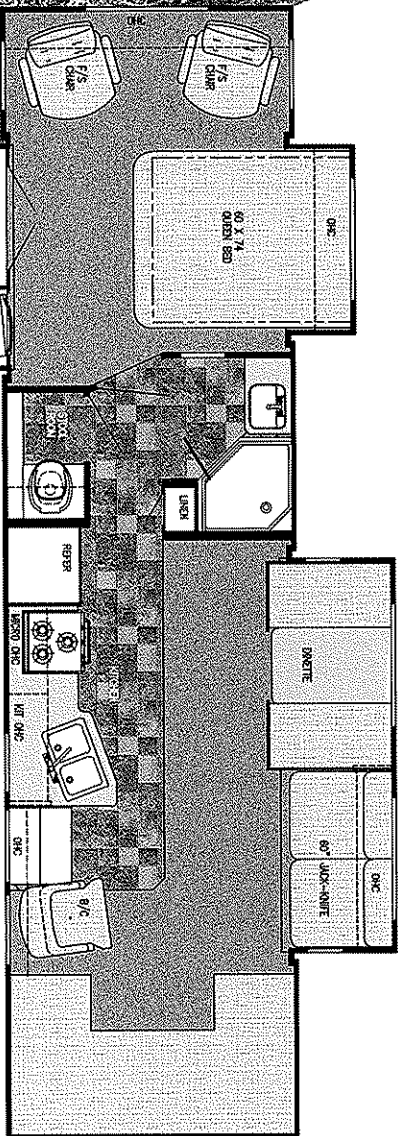

Chassis	Chevy Kodiak
Engine	V 8
Fuel	80
GVWR	19,500
Length	36'-11"
Width	101"
Height w/AC	11'-10.5"
Interior Height	83"
Wheelbase	263.5"
Fresh	34 gal.
Grey	52 gal.
Black	52 gal.
LP Gas Tank	64 lbs.
Furnace (BTU's)	35,000
Water Heater w/DSI	6 gal.

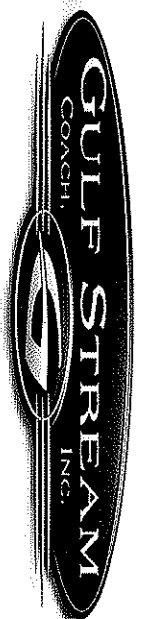
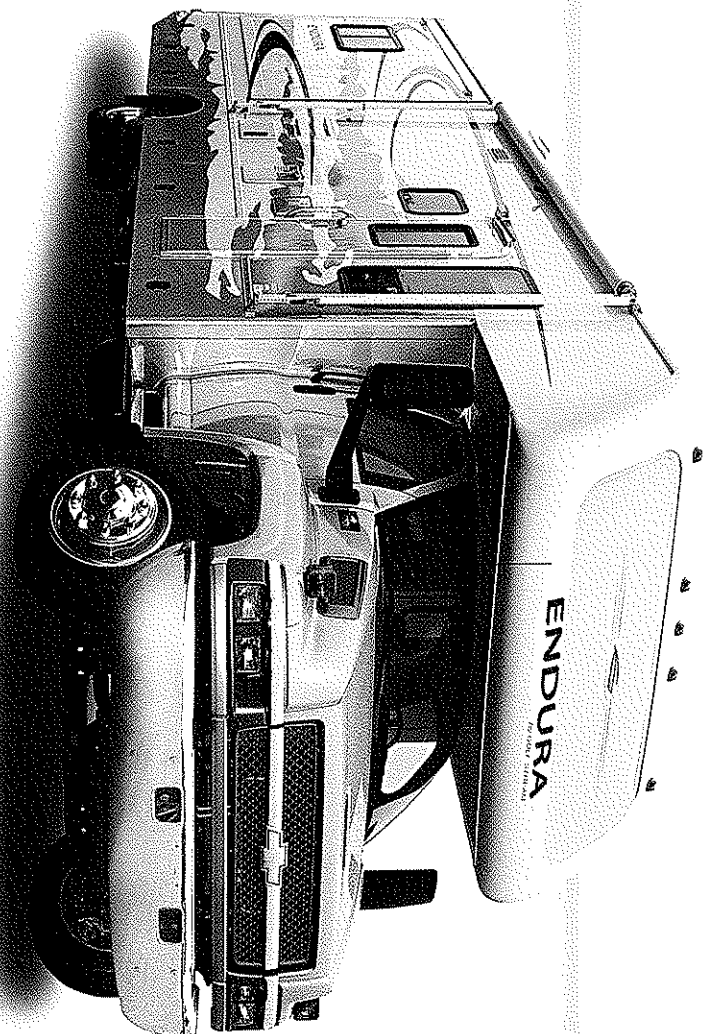

Popular Options

- Upgraded Oak Dash
- Duramax Diesel Engine (N/A 6378)
- Thermopane Windows (N/A 6378)
- Cabover Sleep Area w/ 20" Flat Screen TV & DVD Player
- I.P.O. Overhead Entertainment Cabinet (6378 Std.)

- 19" TV in Bedroom (6378 only)
- 20" Flat Screen Television in bedroom (6340 only)
- Outside Entertainment Center
- Back-up Monitor
- Spare Tire (N/A 6378, N/A 6316)
- 5.5 Onan Generator
- 3-speed Fantastic Attic Vent
- Free Standing Dinette
- Heated Holding Tanks
- Soft-touch Leather Sofa
- Euro Recliner
- Large Double Door Refrigerator

Interior & Decor

- Deluxe Carpet
- Residential Linoleum
- Decorator Clock
- Decorator Mirror
- Valences, Lambrequins & Shades on Windows
- Power Vent in Bathroom
- Vinyl Ceiling
- Hardwood Cabinetry
- Interior Handrail
- Flush Floor Slides
- 5.1 G-sound speakers w/ Full CabOver Entertainment Center 27" Flat Screen Television (N/A 6378)
- Overhead Entertainment Center w/ 20" Flat Screen Television w/ DVD player (6378)

Bath & Water

- Full Size Bathroom
- City Water Hookup
- Skydome
- Deluxe Stool
- Deep Basin Kitchen Sink
- 6 Gal. Electronic Ignition Water Heater w/ Bypass Valve

Appliances

- 3 Burner Range Top
- Double Door Frier
- Convection Oven/Microwave w/ Power Range Hood
- LP Leak Detector
- Carbon Monoxide Detector
- 13,500 BTU Low Profile Front A/C w/ Ducted Roof Air
- 11,000 BTU Low Profile Bedroom A/C

Electrical Systems

- Emergency Start Switch
- TV Antenna w/ Amp & Boost
- Monitor Panel
- Generator Switch & Hour Meter
- CD Player in Cab Area
- Cable TV Ready
- Auxiliary Battery
- 50 amp service w/ auto changeover & converter
- Generator Prep
- Battery Disconnect

Exterior Construction

- Superslick Fiberglass Exterior
- Fiberglass Roof
- Welded Aluminum Cage Construction
- Leveling Jacks
- Laminated Floor w/ Metal Underbelly
- Foam Seal & Undercoating

Chassis

- V-8 Chevy Vortec Engine
- CD Player - AM/FM Stereo w/ 4 speakers
- Power Brakes & Steering
- Radial Tires
- Cruise Control
- Heated/Remote Sideview Mirrors
- Power Windows and Locks
- 2 way Driver and Passenger Seats

- H-A-B Sofa (N/A 6378)
- Jackknife Sofa (6378)
- Pleated Privacy Door
- Free Standing Bedroom Chairs (6378)
- 30,000 BTU Furnace (6316)
- 35,000 BTU Furnace (6340, 6378)

Furniture

- Queen Bed w/ Lifts, Innerspring Mattress, Bedspread and Pillow
- Comfort Plus Dinette Booth Bed
- Single Barrel Chair

24 HR. EMERGENCY ROADSIDE ASSISTANCE

- One Year Coach-Vel Membership
- Towing and Winching
- Flat Tire Change
- Mobile Mechanical
- Delivery of emergency fluids
- Jump-Start / Battery Boost
- Lockout



The Gulf Streamers RV Club is a valuable benefit to all Gulf Stream owners. Members enjoy staying active and participating in the various rallies and caravans offered throughout the United States and Canada. Others simply enjoy the value of receiving their Main Stream, the club's 44-page newsletter, with all its up-to-date product information, service tips and company highlights. Whether or not group camping is a part of your RV use, everyone can benefit from the Emergency Road Service and Gulf Streamers Insurance options. Both are available at competitive rates with friendly, reliable service. Another great benefit is the 10% Program, where campgrounds throughout the U.S. and Canada provide Gulf Streamers with a 10 percent discount on camping. As a member, you'll also receive discounts on National Theme Parks and special attractions, including RV and travel guides, directories and magazines. Rally and caravan participants spend time touring attractions, enjoying fabulous meals, taking in area highlights and shows, while having plenty of free time to relax or explore on their own. Our pre-scouted events include knowledgeable staff to assure you of the best routes, the tastiest restaurants and the friendliest atmosphere to help make the most out of your RV experience. Special rallies throughout the year also include Gulf Stream supplier seminars and complimentary minor repairs by Gulf Stream technicians, Gulf Stream dealer product displays and round your product improvement ideas.

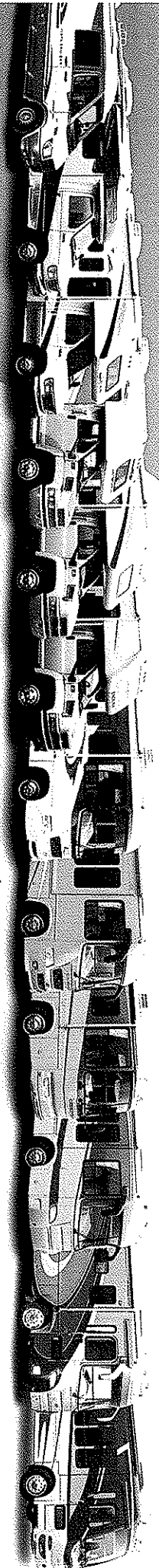

Quality, Comfort, Innovation

Your family and friends will feel safe and comfortable wrapped in Gulf Stream's "Cradle of Strength". Comfort, Quietness and Insulation from the elements is what you will experience from Gulf Stream's "Tried and Tested" Motorhomes. Compare... and you will find the exceptional value of a Gulf Stream Motorhome.

GULF STREAM FACILITIES...

Located in the heart of the Amish country, the complex, along with Gulf Stream's affiliate, Fairmont Homes, Inc., covers over 400 acres and includes more than 1.5 million square feet of state-of-the-art manufacturing facilities. With over 20 years of manufacturing experience producing quality Recreational Vehicles, Gulf Stream is the leading manufacturer of high quality and high value RV products that are distributed through a partnership relation with independent dealers who are focused on meeting customer expectations.

GULF STREAM EXCEPTIONAL VALUE...

Post Office Box 1005
 • Your Gulf Stream Coach Dealer •
 NAPPANEE, IN 46550

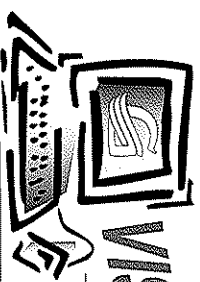

VISIT
WWW.GULFSTREAMRV.COM

**FOR MORE DETAILED INFORMATION...
 OR CALL 1-800-765-8787-EXT. 3288**

For more information and a complete list of options, contact your local Gulf Stream dealer, www.gulfstreamrv.com or Gulf Stream Coach, Inc. Gulf Stream Coach, Inc. reserves the right to make changes in prices, colors, materials, components and specifications and to discontinue models at any time without notice or obligation. Gulf Stream Coach, Inc. assumes no responsibility for any error in this advertisement. Photographs may show equipment or items that are optional and are not included.